

The Wireless World

THE
PRACTICAL RADIO
JOURNAL
25th Year of Publication

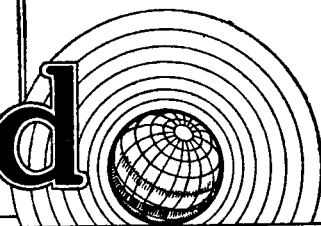
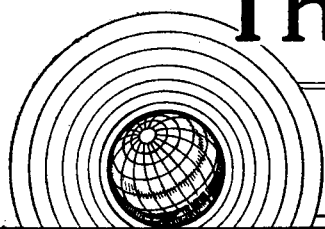

No. 836.

FRIDAY, SEPTEMBER 6TH, 1935.

VOL. XXXVII.

No. 10.

Proprietors: ILIFFE & SONS LTD.

Editor:
HUGH S. POCOCK.

Editorial,
Advertising and Publishing Offices:
DORSET HOUSE, STAMFORD STREET,
LONDON, S.E.1.

Telephone: Hop 3333 (50 lines).
Telegrams: "Ethaworld, Sedist, London."

COVENTRY: Hertford Street.

Telegrams: "Autocar, Coventry." Telephone: 5210 Coventry.

BIRMINGHAM:

Guildhall Buildings, Navigation Street, 2.
Telegrams: "Autopress, Birmingham." Telephone: 2971 Midland (4 lines).

MANCHESTER: 260, Deansgate, 3.

Telegrams: "Iliffe, Manchester." Telephone: Blackfriars 4412 (4 lines).

GLASGOW: 26B, Renfield Street, C.2.

Telegrams: "Iliffe, Glasgow." Telephone: Central 4857.

PUBLISHED WEEKLY. ENTERED AS SECOND CLASS MATTER AT NEW YORK, N.Y.

Subscription Rates:

Home, £1 1s. 8d.; Canada, £1 1s. 8d.; other countries, £1 3s. 10d. per annum.

As many of the circuits and apparatus described in these pages are covered by patents, readers are advised, before making use of them, to satisfy themselves that they would not be infringing patents.

CONTENTS

	Page
Editorial Comment	265
The Berlin Radio Show	266
What Valve Ratings Mean	270
Five-Metre Field Days in Retrospect	272
Current Topics	273
Loud Speaker Progress at Radio-lympia	274
A Briton in Berlin	277
Technical Language	278
Letters to the Editor	280
Random Radiations	281
Listeners' Guide for the Week	282
New Apparatus Reviewed	284
Motional Impedance	285
Broadcast Brevities	287
Principal Broadcasting Stations	288
Readers' Problems	290

EDITORIAL COMMENT

Exhibitions and Demonstrations

Better Conditions Needed

CLEAR indications have been given that all sections of the public are disappointed at the lack of demonstrations of receiver performance at our National Radio Shows. But it seems that nothing can be done about it; the conclusion has been reached that real demonstrations at Exhibitions are impracticable. Although not convinced that the problem is insoluble—and still less that all efforts to find a solution should be abandoned—we must be content to leave that matter as it stands for the present.

But the position is almost equally unsatisfactory with regard to demonstrations of receiver performance to would-be purchasers outside the exhibition season. Both manufacturers and dealers seem to be particularly unfortunate in the choice of their business premises from the point of view of electrical interference, and, doubtless on the principle that everyone expects the shoemaker to be the worst shod, do not always take much trouble in fitting suppression devices. It is not surprising that uninstructed members of the public are unfavourably impressed by demonstrations given under bad conditions; they do not know what allowances should be made for apparent shortcomings.

"High-fidelity" at its Worst

Only those who have heard the indescribably unpleasant hissing background of a real "high-fidelity" set worked under bad conditions will be able to sympathise with the ordinary citizen, who, after such a demonstra-

tion, is apt to conclude that his old set, with its sharp cut-off at 3,000 c/s, is, after all, just as good if not better than the new model. As a result, he firmly declines the salesman's offer of a demonstration at his own house and does not listen to the excuses that are made; he has heard the same story at rival establishments. Thus another recruit to the cause of high-quality reproduction is lost.

The first step towards a better state of affairs is obvious; trade demonstrators should avail themselves to the full of recent advances in anti-interference technique; for example, a five-pound note spent on the erection of a really effective screened aerial is a small matter to a trader, though the buyer of a ten-pound set would consider it to be an unwarranted expense.

Co-operative Demonstrations

Apart from these considerations, range and selectivity can seldom be demonstrated to good advantage in ordinary shopping districts; this concerns both technically minded wireless users and others. It is urged that a few demonstration centres—preferably run by the radio industry in co-operation, but perhaps that is rather too much to ask for—should be organised. The sites should be near large centres of population, but sufficiently far removed from the business and manufacturing quarters of the chosen cities to ensure at least as good reception conditions as those prevailing in the suburban or country homes of the more favoured listeners.

Those who are seriously interested would not begrudge an hour or so spent in travelling to their nearest centre, especially if they knew that a representative selection of receivers would be demonstrated under proper conditions.

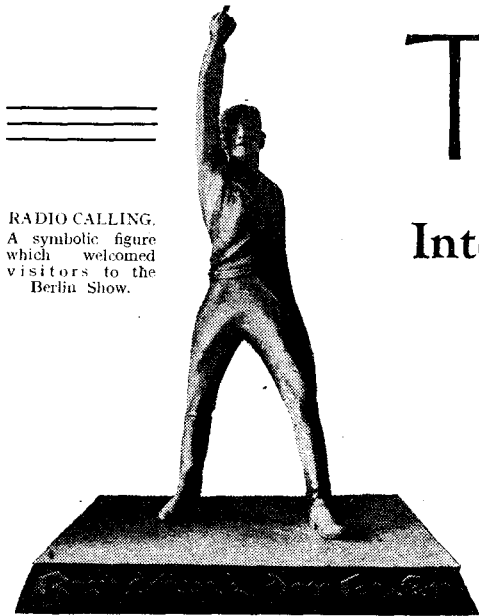

RADIO CALLING.
A symbolic figure which welcomed visitors to the Berlin Show.

The Berlin Radio

Intensive Revival of "Straight" Circuits and Wavetraps

improvement rather than sensational novelty. One of the notable points is the waning popularity of the "reflex" receiver. This receiver came into great prominence last year, because at last suitable valves had come on the market to enable the long-known reflex principle to be satisfactorily employed. This year, however, it seems to have been realised that the economy in valves thus obtained is partly counter-balanced by the need for extra components which are not necessary in a straightforward set. Such reflex receivers as are shown, however, are very

lect seems to have come into its own. This type lends itself to very fair distant reception, with reasonable selectivity, and it can be turned out at a low price.

The DC set has practically disappeared, being replaced by the "all currents" models. However, the new season's AC types are not all available in universal form; it is not always an easy problem to design an efficient universal receiver when the DC voltage is as low as 110 volts. An AC-DC version of the Government-sponsored "People's Receiver" appears this year.

Another change from last year is the general inclination to drop the short-wave portion of small receivers. So far as ordinary broadcast receivers are concerned, the short-wave band is provided almost exclusively in superhet. types, and generally only in those of four valves and upwards.

THE fire which burned out Hall IV of this year's Radio Show was not allowed to interfere for long with the successful run of the Exhibition. The fourteen big exhibitors situated in the Hall were accommodated in the restaurant of the Exhibition and in a large pavilion in front of it, and the two wrecked television transmitters (for providing the transmissions for the television receivers in Hall III) were replaced by two from the State Post Office, so that two days after the fire everything was in order. None of the other halls was touched by the fire, and the Exhibition was not seriously interrupted.

This year's Exhibition occupied eight halls with a total area of 62,000 square metres, and architecturally (even after the fire) was an improvement over those of previous years. The general plan, since the coming into power of National Socialism, of making the Exhibition a popular one and not merely a trade show, was carried out this year with special success.

Recent indications were confirmed by this Exhibition that the keynote of broadcast development in Germany is steady

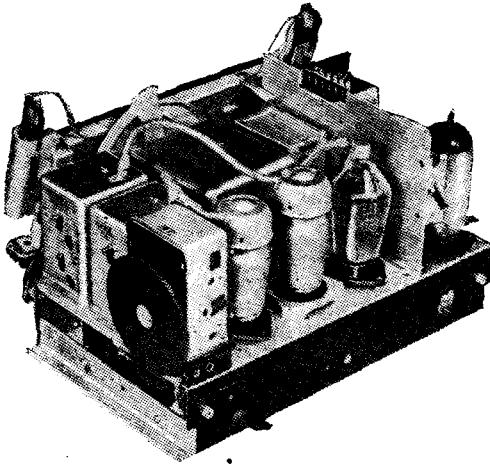

Adjustment of the wave trap in this receiver is effected by the large milled disc, which protrudes through the back of the cabinet.

efficient: their selling point is not so much the reduction in the number of valves as the increased range over other receivers with the *same* number of valves.

To some extent the place of the small reflex set has been taken by the medium-sized 3-valve 2-circuit receiver, which after comparative neg-

Linked Tuning and Aerial Coupling

Perhaps one of the most interesting developments is the automatic variation of the aerial coupling as the tuning circuits are altered, so that the best coupling condition is ensured all over the scale. This is specially advantageous for small sets with their comparatively feeble amplification. The improved aerial coupling allows even single-circuit types to be accurately calibrated, with the result that these types can give good distant reception, with a tuning scale showing quite a number of station names.

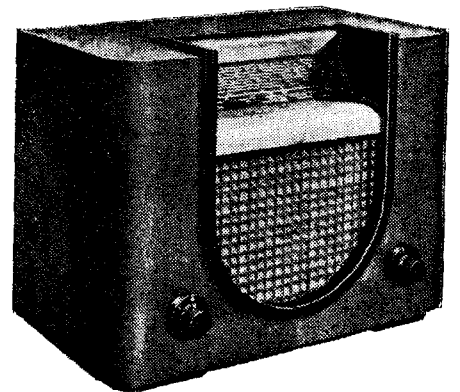

An example of modern German cabinet design: the Telefunken 4-valve superhet. with iron-cored coils, wave-trap, and 3 IF circuits.

Another advantage of the automatic aerial coupling is that the reaction adjustment need hardly be touched when once set.

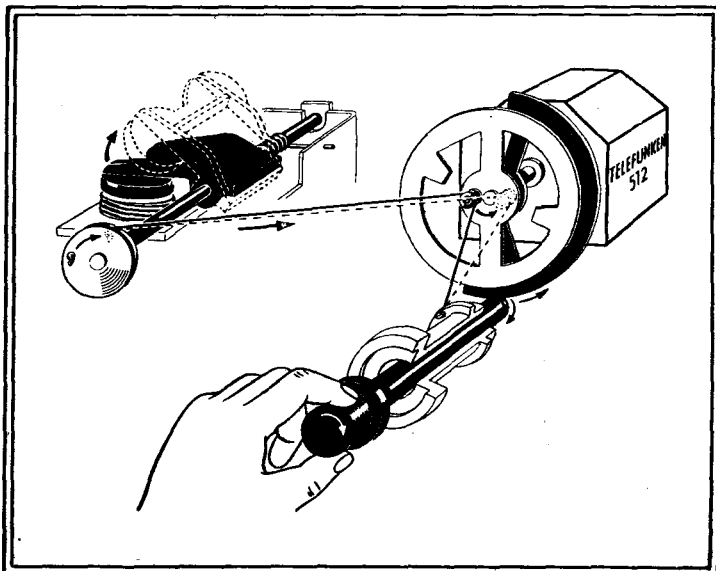

Sketch showing automatic variable aerial coupling system of the Telefunken det.-LF set. Coupling varies with tuning, movement being transmitted through a cord drive when the variable condenser is rotated. Initial adjustment is made by the disc behind the tuning knob.

Show THE TWELFTH GREAT GERMAN WIRELESS EXHIBITION REVIEWED

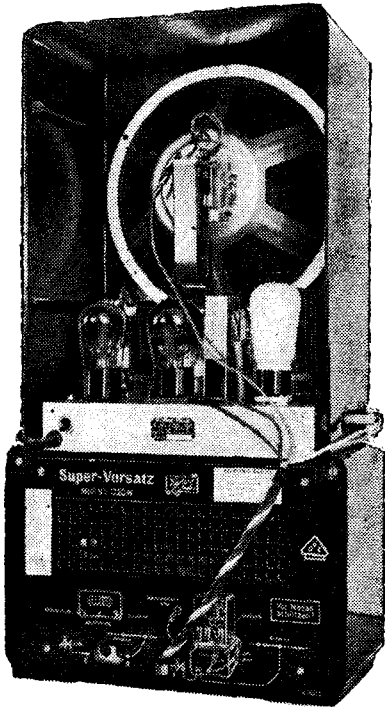

Rear view showing connections between the People's Receiver (above) and the new unit which converts it into a superheterodyne.

As typical examples of the latest practice in simple detector-LF two-valve sets, the A.E.G. and Telefunken models may be mentioned. These both embody automatic aerial coupling, screen grid detector valve, magnetic reaction, and resistance coupling between detector and output pentode.

A high reduction ratio for the tuning control is obviously as essential as ever, if not more so, for to-day's highly selective receivers. But this year the manufacturers have made a point of getting rid of the tediously slow change from one station to another. Various methods of "quick tuning" are used, the most general, perhaps, being the two-speed

drive, operated by pulling out the tuning knob for quick motion and pushing it in for fine adjustment. Moreover, this improvement has been accompanied by the provision of "silent tuning," hitherto confined to large and expensive receivers, but now extended to such medium-priced types as the two-circuit receivers.

Dial Telephone Tuning

A very interesting tuning system is employed in the Neufeldt and Kuhnke receiver, station selection being carried out by an automatic telephone dial. A series of silver strips, forming with a metallic backing the oscillator tuning condenser, are deposited on a Calit disc, so that 121 different capacities, corresponding to the same number of stations, are obtained.

Variable selectivity, which enables the best possible quality to be

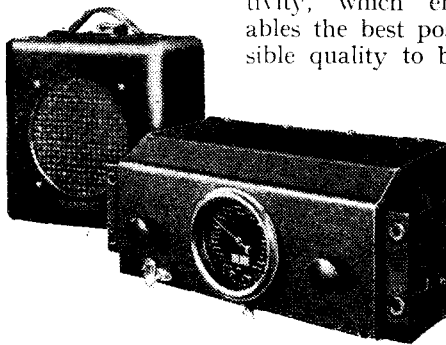

A four-valve superhet circuit is employed in the Mende car radio set, which is arranged for direct control. The remote-control principle is also used in Germany.

obtained for any particular conditions, appears in a large number of this year's receivers, both superhets, and those of the HF-det-LF type which are provided with the necessary bandpass filter (three circuits in all). For most distant stations the band filter is set to pass the usual 9,000 c/s band, so that notes above 4,500 c/s are cut out.

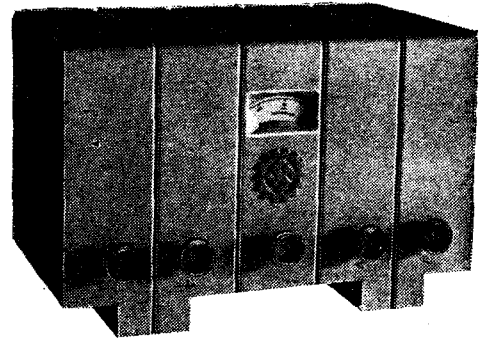

The "Labour Front" receiver, with a high-power output stage, is designed for communal reception in factories and institutions.

But when (for instance, with a local station) signals are so strong that a wider band can be admitted without interference, the band width can be adjusted so that high-quality reception is possible.

Among the superheterodynes including the feature of variable selectivity, the "Ideal" receiver is particularly interesting; a "flywheel" quick-turning device is employed, and there is no wave-change switching; the circuits are automatically adjusted for the long-wave band by an auxiliary condenser which comes into play when the upper end of the medium band is reached. In some of the receivers selectivity is continuously adjustable, while in others, such as the Schaub "Schwarzwald" it is variable in steps.

Model T586, one of the more ambitious Telefunken sets, also has a three-position selectivity adjustment; other features are silent and quick turning, push-pull triode output, and an interesting volume-control

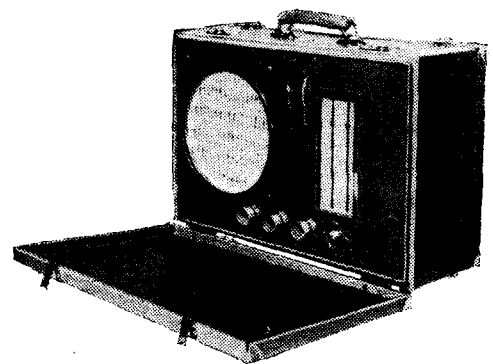

An example of a German portable; the Seibt 4-valve superheterodyne.

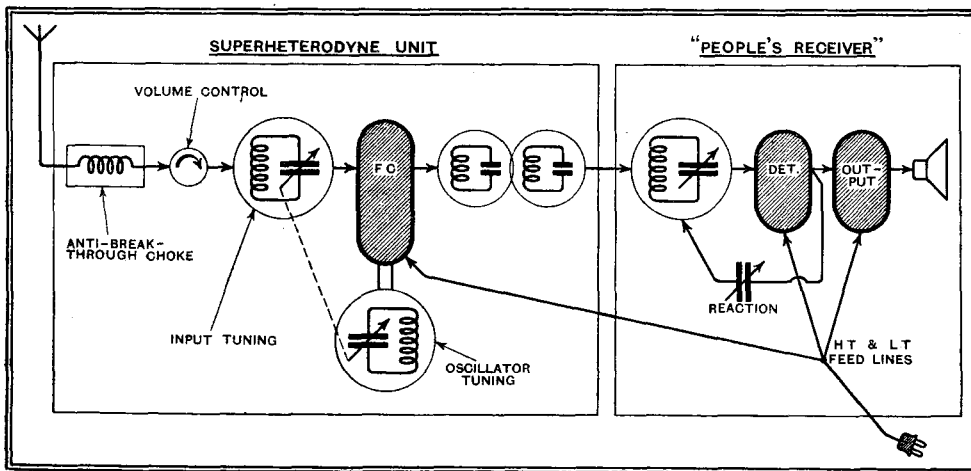

Diagram showing method of adapting the People's Receiver by means of a converter unit. Interconnection between the two units is made very simply without soldering.

system which, it is claimed, follows the sensitivity curve of the human ear. The Körting "de luxe" superhet. has a visual indicator showing the breadth of the band to which the circuits are adjusted.

Particular attention has been given this year to wave traps, not only for small but also for medium receivers and superhets. These traps are mostly made with iron-cored coils, and they raise the effective selectivity of the whole receiver very con-

The Berlin Radio Show—

siderably. They figure even in superheterodynes, and are provided with fine adjustment. There is a marked tendency to provide a wave trap for the long-wave band as well as the medium; this second trap is, in many receivers, built in as an

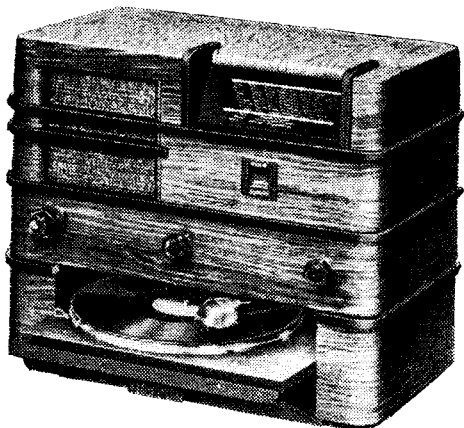

A table-model radio-gramophone, with turntable on a sliding flap. A four-valve AC/DC superheterodyne circuit is used.

additional component; in others, the medium-wave trap is adapted to the long waves by switching or by plugging-in an extra coil.

In one of the Telefunken sets, semi-variable adjustment of the constants of the trap circuits is provided, in order that the best possible elimination of local interfering stations may be obtained on any wavelength in any locality.

The external design of this year's receivers is artistically more pleasing. There is a tendency to get away from the "vertical" design (with the loud speaker below or above the tuning scale), but even those sets which retain this design are more decorative than last year.

With regard to mechanical details, one

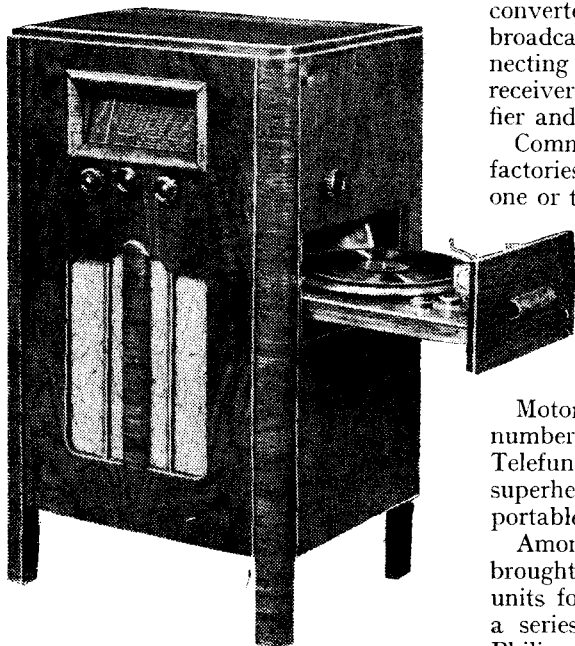

The pull-out turntable is also used in an upright radio-gramophone (Stassfurt).

or two sets have an adjustable tuning scale, of which the angle may be set to suit the eye level of the user. Control knobs

mounted on the side of the cabinet in an unusually convenient position for operation appear in the Saba 335WL. By mechanical means, the tuning dial of the A.E.G. "Weltmeister" is arranged to give "straight-line" distribution of stations over the scale, even at short wavelengths.

A point worth mentioning is that many two-circuit HF-det.-LF receivers are fitted with a duo-diode valve, giving a certain degree of AVC. Economy has been carried to great lengths in the "Topas" two-valve single-circuit AC set, in which consumption of mains current may be optionally reduced when low volume is required by halving the voltage applied to the rectifying valve.

Körting shows a converter unit for changing the "People's Receiver" (of which 1,200,000 have already been sold) into a superhet, the receiver—tuned to 800 metres—acting as IF amplifier, 2nd detector, and LF amplifier.

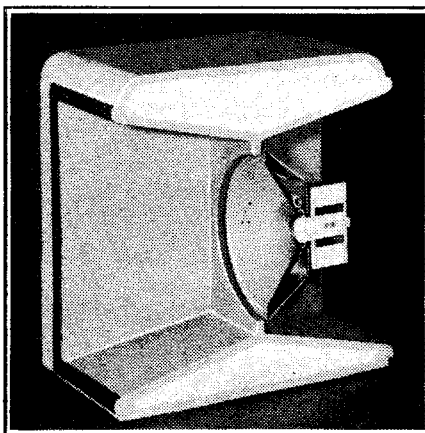

Photograph of a sectional demonstration model of the Lenzola baffle-box, which is packed with acoustically "dead" material.

Telefunken show an ultra-short wave converter unit for use with an existing broadcast receiver; this is a device for connecting to the pick-up terminals of the receiver, which thus acts as an LF amplifier and loud speaker.

Communal reception in blocks of flats, factories or institutions is provided for by one or two firms.

Battery sets include some excellent 2-circuit types and a 4-valve superhet. (Nora, Seibt, Owin). The design of these sets is made possible by the availability of new battery-driven valves.

Motor car receivers are in greater numbers than last year (Mende, Körting, Telefunken). They are all 4-valve superhets., as also are the suit-case portable sets of Seibt and Körting.

Among LF amplifiers, Telefunken have brought out several good Class "B" units for all usual outputs. Körting has a series of class "A" amplifiers, while Philips shows a new 17-watt amplifier.

Home recording of gramophone records receives less attention than last year, but Dralowid and Schüler have developed their processes. The Schüler "Wuton" recorder, for example, is provided with

an indicator at the distant microphone point to show how much of the available record track has been used up at any moment during a recording. The indicator is actually a meter, and movements

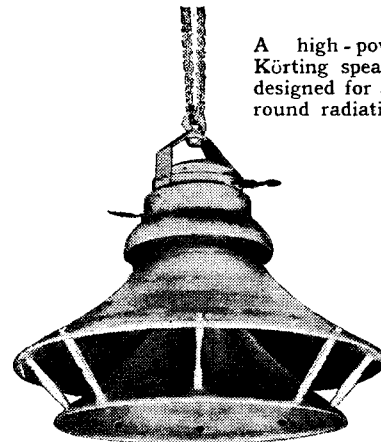

A high-power Körting speaker designed for all-round radiation.

of the tone arm control the amount of current flowing through it by varying the value of a series resistance.

Among the loud speakers we find very good permanent-magnet moving-coil instruments using Oerstit steel, which allows field strengths up to and even exceeding 12,000 gauss to be obtained. Philips shows a high-power loud speaker with permanent magnets. Körting uses outside centring, and for the special reproduction of high notes has a so-called "high-tone" horn loud speaker. Twin speakers now appear in some of the more ambitious sets. Very noticeable are several new non-directional loud speakers of the "mushroom" type, while the directive loud speaker made by Grassmann has a square-sectioned wooden horn, designed to make use of radiation from the back of the cone by means of an unusual deflecting system. Lenzola seeks to improve the low-note reproduction of MC loud speakers by enclosing the

speaker in a housing which is of horn shape and made of acoustically "dead" material.

Turning to components, Siemens offers a kit of parts, ready boxed, for a

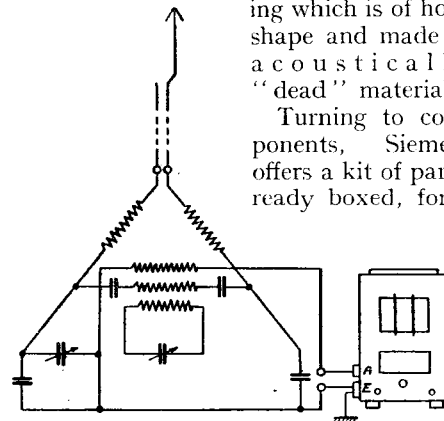

Circuit of the Görler suppressor for balancing out interference picked up by the aerial. An auxiliary wire, running parallel with the download, is used for the injection of balancing voltages. Diagram is drawn German fashion; resistance symbols represent inductances.

constructional set. One or two firms have developed very useful valve-testing apparatus, easy to use. Hescho presents new ceramic condensers, including variable condensers using "Calit" and

The Berlin Radio Show—

“Condensa,” with films of silver, and high-voltage condensers of “Condensa” with special edges to prevent spark-over.

Of special importance are the new dielectric materials “Tempa S and N,” with very small temperature coefficients. Another way of obtaining condensers unaffected by temperature variations is to combine the use of Calit with the use of Condensa C, on the principle of the bi-metal watch balance-wheel. Among aerial materials may be mentioned the new basket aerial shown by Kathrein, and the Telefunken steel-tube aerial with plug-in sections. The compensation circuit devised by Görler is interesting in the field of interference elimination.

Television

Television reception is shown in Hall III. Round the walls are the private stands of the television firms and the Post Office, while the middle of the room is occupied by two long stands on which about thirty receivers are exhibited, so that the public can pass along these stands and get an excellent view of each receiver.

The firms taking part are Telefunken, Fernseh A.G., Lorenz (Ardenne), Loewe, Philips, and Tekade. All these except the last use cathode-ray tubes working with combined sound-and-vision ultra-short-wave receivers. Tekade keeps to its mirror screw, the latest type of which is designed for the “line jump” process (alternate-line scanning, all the odd lines first and then all the even lines). The object of this system is to reduce flicker and increase brightness, without increas-

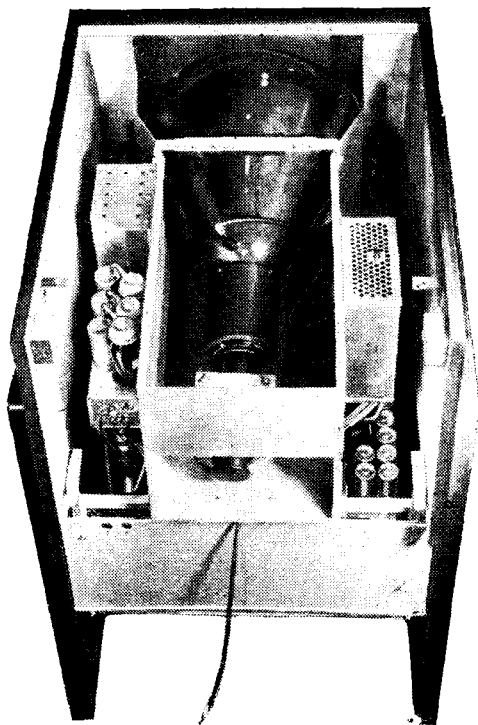

Interior of the new Telefunken television receiver.

ing the necessary band width in the ether. The new 90-line mirror screws for the alternate-line system have silvering on both sides of the mirror. Tekade again

uses a strip-producing light source modulated by a crystal cell.

The Fernseh A.G. again show their large-projection television receiver using the “intermediate-film” principle, the image being photographed on a cinema-film, which is used immediately after development, and, while still wet, is projected on to a large screen. Telefunken, with Prof. Caroluo, have constructed a large screen with 10,000 small lamps, connected by leads with a mosaic of photo-cells on to which the image of the subject is projected. This system of tele-



New Telefunken television receiver, with built-in speaker. Another model is available for use with an existing receiver and an ultra-short-wave adaptor.

vision could be used, for instance, to project on a large screen the portrait of an orator in a large hall.

Short-wave Broadcasting

THE vexed question of “verifications” has been much to the fore in the correspondence columns of certain overseas journals, wherein many listeners have been severely criticising the B.B.C. for its policy of refusing to give specific confirmation of reception.

One would have thought that short-wave reception was so far advanced nowadays that the “veri” craze would have died a natural death. It has not the personal appeal that the QSL-card has to the amateur transmitter, and savours strongly of pure “swank.”

Conditions are still extremely good, particularly for North America, although the 19-metre stations have occasionally been subject to bouts of severe fading for an hour or two before sunset. Their schedules will probably be changed very shortly, as the fade-out is occurring at a considerably earlier hour than was the case a month or so ago.

WIRELESS ENGINEER

Principal Contents of the September Number

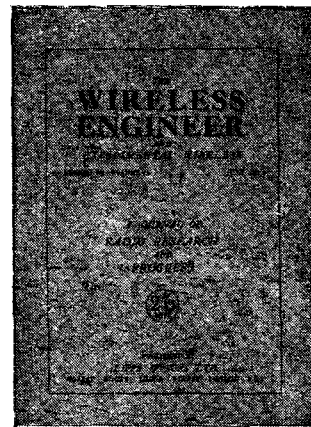

AN R.F. MEASUREMENT OF RESISTANCE, REACTANCE AND IMPEDANCE. By T. C. Macnamara
THE DETECTOR LOAD. By W. F. Cope, B.A.
OLYMPIA 1935—A REVIEW
THE OPTIMUM DECREMENT OF BAND-PASS FILTERS FOR THE RECEPTION OF TELEPHONY. By D. A. Bell, B.A.
EXPANDING VOLUME AMPLIFIERS. By T. S. E. Thomas, B.Sc., Ph.D.
GRID COMPENSATED POWER AMPLIFIERS. By W. Baggally
ABSTRACTS AND REFERENCES

The schooner “Effie Morrissey,” famous owner of several call-signs during the last ten years (VOQH and W-10 XDA come to mind) is now active once more with the call W-10 XFP. Working on 21.2 metres at irregular times, this boat will doubtless provide listeners with a few more thrills.

Incidentally, this wavelength is within the confines of the 20-metre amateur band, which seems to be in danger of being appropriated by so-called experimental stations and even regular broadcasts. The latest list of broadcasting stations gives Cali, Columbia (HJ5ABE), as working on 21.3 metres.

A surprising number of stations in the West Indies has been heard recently. The new Cuban, COCD, on 48.92 metres, is one of the strongest, but just below, on 47.5 metres, is a very good transmission from Santo Domingo (HIZ), announcing as “La Voz de Los Muchachos.”

HI4D, another station in Santo Domingo, works on 45.5 metres, and is also heard very well in this country. Altogether there are ten or twelve stations in the Dominican Republic, all their call-signs beginning with “HI.” HI7G is a well-known amateur telephony station working in the 20-metre band, and his transmission compares favourably with many of the regular broadcasts.

A new Venezuelan is YV8RB, working on about 51 metres with 400 watts. This station is located at Barquissimeto, and has been logged in this country between 2 and 3 a.m.

The best time for the logging of unfamiliar stations between 40 and 50 metres is undoubtedly the period between midnight and 4 a.m., and listeners who are sufficiently hardy and enterprising to make use of it are bound to find some very interesting transmissions.

A very interesting Japanese transmission for those who have the opportunity of listening at about 10 a.m. is that of JYR (Tokio) on 38.07 metres. It seems to be a fact that the stations operating outside the official broadcast bands come over with much greater strength and reliability than those that are! MEGACYCLE.

What Valve Ratings Mean

How Amplification Factor, Impedance, and Mutual Conductance are Related

By M. G. SCROGGIE, B.Sc., A.M.I.E.E.

A HELPFUL introduction to valve technicalities, specially written for new readers. It is shown why the widespread tendency to regard the valve with the highest amplification factor as the best is fallacious, and a more correct basis for assessing the "figure of merit" is described.

READERS who know all about valve characteristics need go no farther. The following is an attempt to enlighten those who are puzzled to know, or do not yet know, that amplification and amplification factor are quite different things and who are not sure whether a 5,000-ohm valve is better or worse than a 10,000-ohm valve. Of course, a whole series of articles would be needed to go into these things at all fully; but as my impression is that the first step in such matters is less often dealt with in published articles than the later ones, here (I hope) it is.

Apart from the particulars relating to filament or heater voltage, the purpose of which is quite obvious, and the anode, screen, etc., voltages, valves are distinguished, in their specifications, by three numbers. Sometimes only two are actually printed on the instruction slip; but, as we shall see, the third can very easily be got from the other two. These numbers go under various names, so to prevent any subsequent confusion, I give them in full at this point:

(1) Amplification factor, μ , or mu. This is just a number.

(2) Impedance, AC resistance, differential resistance, anode resistance (a bad, because ambiguous, term), R_a . This is measured in ohms.

(3) Mutual conductance, transconductance, slope, goodness, G , G_a . This is measured in milliamps per volt.

Now these figures are intended to answer two questions: What will the valve do and which of any two valves is the better? But the way in which the specified figures lead to the answers is not as obvious in the case of valves as it is in some other commodities sold with numerical specifications.

An electric lamp, for example, is rather like a valve but is much easier to understand. It is rated to take so many watts from the electricity supply, and you know that a 60-watt lamp will cost three times as much to run as a 20-watt lamp. If they are of equal efficiency it will give three times as much light; and it is a pity that candle-power figures are not more generally supplied, for then one would be able to compare one lamp with another in efficiency by calculating very simply a third figure; namely, candle power per watt.

A large proportion of valves are used for amplification. Broadly, one may consider that a valve which amplifies twice as much as another is twice as good. But only broadly; for the greater amplification may involve drawbacks. When some valves have amplification factors of hundreds, and others sold at comparable prices have factors of only 2 or 3, there

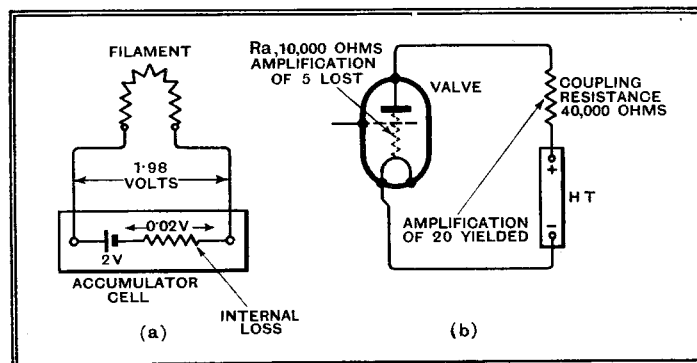

Comparison between drop in volts when a battery is used to supply current, and (diagram (b)) loss of amplification when a valve is connected up to its coupling circuit. The valve given as example is supposed to have an amplification factor of 25, of which 20 is actually realisable in the condition shown.

is obviously more to be said. When you buy binoculars or telescopes you are told the magnification, which is quite a definite thing. It is the enlargement that the instrument actually gives you. But a valve with a μ of 25 may in normal practice give an amplification of from 10 to 100, or an even wider range. It all depends on how much one may find it practicable and convenient to use.

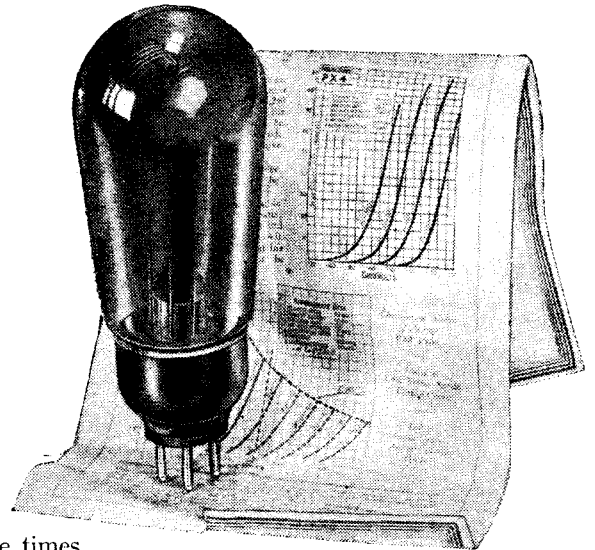

Now, although I am supposing that you, the reader, are not quite *au fait* with valve theory, I am afraid that in the interests of brevity I shall have to assume at least a nodding acquaintance with Ohm's Law.

Suppose you have a 2-volt accumulator cell which you are using to run a single valve taking 0.1 amp. You measure the voltage with a very accurate voltmeter at the terminals of the cell before and after switching on the valve. Before, it is exactly 2.00 volts. Afterwards it is 1.98. For all practical purposes it is still 2. But why has it dropped at all? Simply because the current that goes through the filament of the valve has to go through the cell itself, so that the voltage that formerly appeared at the terminals now has to be shared between itself and the valve. The cell keeps 0.02 volt and passes on 1.98, or very nearly 2, to the valve. This means that the resistance of the valve filament is 100 times that of the accumulator, or 20 ohms and 0.2 ohms respectively. In such circumstances practically the full voltage is actually accessible for the purpose. But if now something with a resistance of only 0.2 ohm is connected to the cell the voltage is shared equally, and only 1 volt is registered externally; the other volt is absorbed within the cell.

Realisable Amplification

Anybody who can follow this will have no difficulty in understanding how the valve amplification factor operates. It corresponds to voltage in the accumulator illustration. A valve with a factor of, say, 25 under certain conditions of anode and grid voltages, is theoretically capable of an amplification of 25. But the valve, like the accumulator, has an internal resistance between filament (or cathode) and anode; that is where our next item

What Valve Ratings Mean—

appears— R_a . But whereas in any decent accumulator the resistance is so low as to be negligible for most purposes the resistance of a valve is not at all negligible; in fact, it may be much the biggest in the circuit—tetrodes and HF pentodes are sometimes over a megohm. At the lowest it is usually a thousand or two in ohms.

Unless the external, or coupling, resistance is very large it is clear that a considerable portion of the theoretical amplification cannot be got at, being absorbed in the valve's R_a . There are various reasons why the coupling resistance, or impedance it may be, cannot be increased indefinitely. If it is a resistance it requires extra HT volts to ensure that the valve is not starved. If it is a choke or transformer winding there may be difficulty in maintaining it sufficiently large or constant over the band of frequencies in which one is interested.

That is why it is not enough to know μ only; two valves of equal μ may be very different in the amplification obtainable in practice. Hence R_a .

Neither of these pieces of information by itself enables one valve to be compared with another for merit. And given both together it is necessary to perform a slight calculation—naturally a most tedious business. If one valve has half the amplification factor of another it is reckoned to be equally meritorious if it also has half the resistance. So for purposes of comparison, to avoid the labour of dividing one number by the other, a single number is quoted, being $\frac{\mu}{R_a}$. This

is our third number, the slope, or mutual conductance, or G. By a curious coincidence (if one isn't sufficient of a mathematician to have seen it all along), G is the number of milliamps. change in anode current—the anode being connected straight to +HT— for each volt change on the grid. And as a valve that gives a large number of milliamps. per volt must be represented by a steep line on a graph of anode-current against grid voltage, it is an extremely natural though not strictly accurate thing to call it the slope of the valve.

Incidentally, there is no reason why one cannot specify the *screen* milliamps per

grid volt where there is a screening electrode in the valve, which figure constitutes another sort of mutual conductance. So our sort is sometimes called G_a to make sure of it; though, as it is very rarely that any other sort is considered, there is small risk of confusion.

A Basis for Comparisons

Valves having widely different μ and R_a may have the same G. It happens to be rather easier to achieve a high G when the μ is low. But it is still a useful comparative figure for valves that are not too enormously different.

A few paragraphs ago I took as an example a valve with a μ of 25 *under certain conditions of anode and grid voltages*. All three numbers are accompanied on the valve specification sheet by a little note to the effect that they are "at anode volts = 100; grid volts = 0," or something of the sort. That is because they are not absolutely fixed quantities, like the number of cylinders in a particular motor car, but vary somewhat according to condition of use, like the miles per gallon. As it happens, the μ varies comparatively little, even in the so-called variable- μ (really variable mutual conductance) valves. It is the resistance that changes substantially, and hence with it the slope.

It is wise to remember that the specified figures are not absolute fixtures, for although measured at zero grid volts it is very rarely that valves are used in such a condition, and things may be very different when a few volts of negative bias are applied. The very high- μ valves particularly are likely to fall off in such circumstances.

Going back to another paragraph; it has been explained fairly fully why a valve with an amplification factor of 25 may give an amplification of only 10, but it is not clear from this how it may give an amplification of 100. Looks like something for nothing. The answer, of course, is a step-up transformer. And it is *not* something for nothing; what is gained in voltage is lost in current, so much so that if the transformer gives a very high ratio of step-up a low resistance valve may be necessary to maintain the current; and that means, in general, a low μ ; so the net result may be no more exciting than with a small step-up, or no step-up at all.

There is no one figure, or even two or three, that can tell the difference between a good type of valve and a not-so-good type. There are other matters to be taken into account; notably output power, but also inter-electrode capacities, and other things. But before studying them one must be clear about the Big Three.

In Next Week's Issue

The Three-in-One Portable

**An Easily Built
Extra Receiver
of Many Uses**

CONSTRUCTIONAL details of a light-weight "stand-by" receiver, designed for use on those innumerable occasions—out of doors, when travelling, or even in the home—when ordinary facilities for broadcast reception are lacking.

The true portability of a receiver is not entirely determined by its weight and bulk; considerations of shape and external layout also affect the ease with which it may be carried or packed away.

These various factors have all been taken into account in designing this highly practical set, which combines the desirable features of compactness and lightness with extreme simplicity; unlike many other portable sets, construction is exceptionally easy. Cost of the component parts required is low.

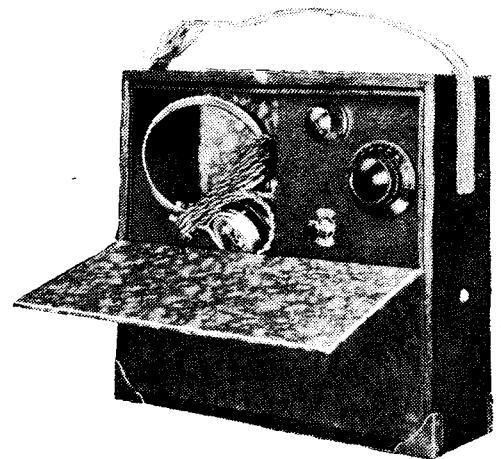

- | | |
|---|------------------------------|
| 1 Fixed condenser, 0.1 mfd. | T.C.C. 253 |
| 1 HF Choke | Wearite HFPJ |
| 1 LF Transformer, 1:5 | Varley "Nictet" |
| 3 Valve holders, 4-pin | Bulgin VH7 |
| 1 Three-point switch | Bulgin S36 |
| 1 Grid Leak, 2 megohms | Eria |
| 1 Telephone Plug | B.T.S. |
| 1 Three-Spring Automatic Jack | B.T.S. |
| 1 Valve Connector | Belling-Lee 1175 |
| 2 Wander Plugs and 2 Spade Ends | Eelex |
| 1 LT Accumulator, 2 volts, 11 ampere hours | Exide PY3 |
| 1 HT Battery, 60 volts | Drydex H1003 |
| 1 Pair Headphones | N.R.S. "Jubilee" Lightweight |
| 20 yards Litz Wire and 2 ozs. No. 25 D.S.C. Wire for frame aeri-als. | |
| Wood, Screws, Systoflex, small quantity No. 22 tinned copper wire, etc. | |
| Valves: 2 HL2/K, 1 V824/K | Osram |

LIST OF PARTS

- | | |
|---|--------------|
| 1 Variable condenser, 0.0005 mfd. Log Law | Ormond R/503 |
| 1 Dial for above | Ormond R/352 |
| 1 Differential condenser, 0.0002 mfd., and knob | Ormond R/510 |
| 1 Fixed condenser, 0.0001 mfd. | T.C.C. "M" |
| 2 Fixed condensers, 0.0005 mfd. | T.C.C. "M" |

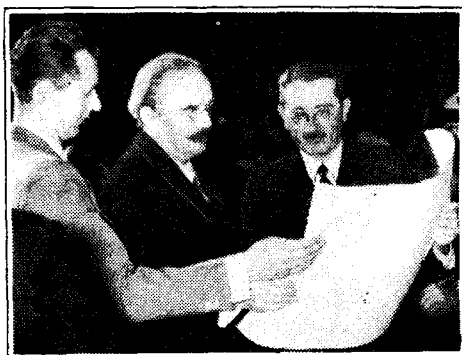

Dr. PAUL NIPKOV, inventor of the famous television disc, was honoured at the Berlin Radio Show on the occasion of his 75th birthday. The picture shows Dr. Nipkov reading the certificate of his honorary doctorate of Natural Science granted by the University of Frankfurt.

Five-Metre Field Days in Retrospect

The Observations of a Participant in Ultra-short Wave Experiments During the Past Year

By H. B. DENT

THERE are very few wavebands now left unexplored in the radio spectrum, and it is becoming increasingly difficult for the amateur experimenter to find new terrain for his activities. Even the ultra-short wavelengths are being investigated by professional workers, but the amateur can still add his quota to the general fund of knowledge, for the very good reason that as yet little reliable data is available regarding the propagation of these very high frequencies.

Whilst the professional will be interested mainly in the performance of high-power transmitters using well-elevated aerials, the amateur can do some good and useful work with small portable sets employing aerials of but a wavelength or so in height, under which conditions the screening effects of low hills and other topographical features can be investigated.

The distances over which communication may be expected will be largely dependent on the transmitting site chosen and the height of the aerial, and so far it has been the aim of all amateur experimenters interested in this work to place the transmitter on the highest promontory available.

Location of Transmitter

During the past year the Golders Green and Hendon Radio Society organised several five-metre field days in the neighbourhood of Ivinghoe, the transmitter being located near to the Beacon Hill though not actually on the highest point, but at an elevation of about 700 feet above sea level.

The country hereabouts offers ample scope for investigation, for to the north, north-west and west the country is comparatively free from hills higher than the Beacon, but in the east and the north-east an interesting problem is presented by the Dunstable Downs, quite as high, if not higher in parts, than the site of the transmitter.

The writer has been able to participate in all these experiments, and at different times has explored the country with a portable superheterodyne.

Subsequent discussions with other receiving parties, coupled with first-hand experience in most of the surrounding country, has revealed that receiving conditions differ widely; the north, north-west and west have provided the best hunting ground from the point of strongest signals and greatest distance, it being virtually impossible to get out of range of the transmitter within the time available and allow-

ing for frequent stops to make observations.

The presence of high ground interrupting the visual line between receiver and transmitter does not necessarily preclude reception, though a long spur, such as that presented by the Dunstable Downs ridge, entirely blanked out signals in those areas explored beyond it. It is more than probable that this ridge threw a shadow only, and that reception of the transmitter would have been possible had the receiver been taken farther afield, though this point must be verified on a future occasion.

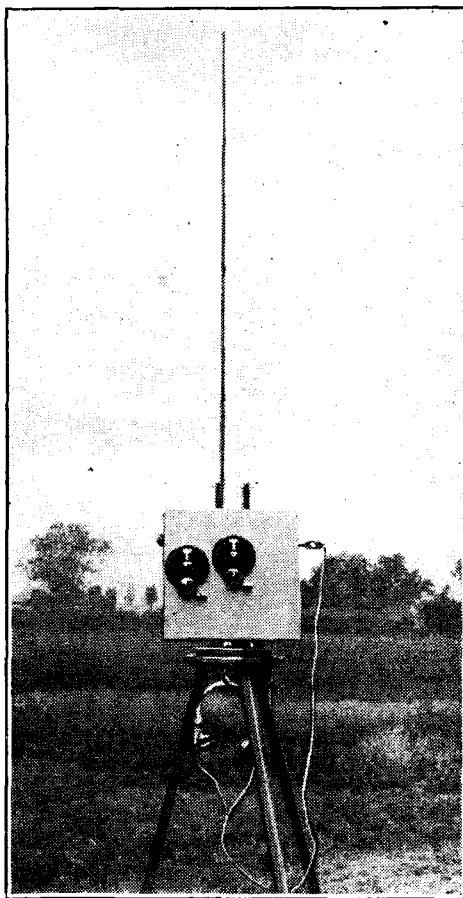

Portable five-metre superheterodyne designed for field day use and fitted with a vertical aerial

Reception where hills intervene was definitely recorded by Col. Ashley Scarlett and Mr. Maurice Child during the last field day. The receiving site was accurately located on the map and a sectional drawing prepared from the contour lines showing the nature of the intervening country. This revealed two high hills, both of which interrupted the visual line; signals were appreciably weaker here than at a more favourable site the same dis-

tance from the transmitter, approximately twenty miles in each case.

At distances beyond about eighteen miles some receiving parties encountered the phenomenon of high-speed fading; this, however, did not appear at lesser distances. It is only by full discussion of the results obtained by all taking part in these experiments that such useful data can be collected.

Recording Results

It is essential, therefore, that everyone taking part should keep an accurate log of the results obtained, negative results often being quite as valuable as a particularly long-distance reception, though less satisfying to the participant. The full value of the experiments only comes to light when all reports are collated and all the surrounding country has been explored, for a rough map can then be prepared and good and bad localities marked thereon.

The next step is to investigate further the black areas, using various styles of transmitting aerials with the view to ascertaining whether signals can be injected into these parts without affecting reception in the good areas. In the present case eastward of the transmitter represents the black country, and there can be no doubt that some useful work has yet to be done in this area.

A feature of these outdoor exercises is that quite simple equipment suffices for receiving over the longest distances necessary. It also provides an opportunity to compare the performance of different designs if one so desires, but where serious investigational work is being attempted only one set can be satisfactorily handled by a single operator in conjunction with a colleague acting as a navigator, log-keeper, and general adviser. A party of three can deal with two sets, two operators, and one as log-keeper for both.

The receivers must be as compact as possible, easily assembled for reception and dismantled, and provision should be made for using either a horizontal or a vertical di-pole aerial. Alternatively, elevated aerials of this pattern can be employed, raised on quickly assembled sectional masts. Such field days can provide data apart from investigating the propagation in open and close country; they enable the experimenter to try out different aerial systems in conjunction with the main work in hand, for the type of aerial that gives the best results under these conditions will be applicable to television receivers in the near future. It may thus be possible to answer with confidence the question that sooner or later all experimenters will be asked by friends and relations, viz., what is the best aerial for receiving television? Though it will be surprising if all agree on this point.

Current Topics

Events of the Week in Brief Review

Anti-noise Move

COPENHAGEN'S latest by-law forbids the operation of loud speakers at open windows after 10 p.m.

Best Television Device

GERMAN radio officials are under no illusion as to the present state of television. Herr Hadamovsky, Chief of the Broadcasting Organisation, said recently: "The best television device to-day is a pair of field-glasses."

French Giants Testing

OUR Paris correspondent reports that several of the new French regional stations are now officially testing. Lyons-Tramoye (90 kW) has been operating for several weeks,

Wireless at Shipping Exhibition

WIRELESS will be well to the fore at the Shipping, Engineering and Machinery Exhibition which opens at Olympia on Thursday next, September 12th.

Among films to be shown by the National Physical Laboratory in the cinema display in the Gallery will be one giving a simple explanation of the functioning of the cathode-ray tube. This film was originally shown at Radiolympia, 1934, and received high praise as one of the best explanatory films yet made. The N.P.L. exhibit will also in-

Oldest and Youngest

BRISBANE (Australia) claims the unique record of having the oldest and youngest amateur radio operators in the British Empire. They are Mr. Philip Hardgrave, aged seventy-eight, of station VK₄PH, and Miss Madeline McKenzie, aged twelve, of station VK₄GK.

Mr. Hardgrave, a retired solicitor, qualified for his amateur's proficiency certificate two years ago, obtaining 94 per cent. marks for operating and 75 per cent. in the technical tests. His enthusiasm knows no bounds, for he keeps his own card index of every amateur station in

a good selection of leading Scandinavian broadcast receivers. Several sets are disposed of every week in exchange for fish which Mr. Davidsson takes back to his home town, Thorshavn. In hot weather he has to indulge in a little pardonable price-cutting.

N.R.E.A.

THE radio shows in London and Glasgow have given a big filip to the growth of the National Radio Engineers' Association, and the membership curve shows a steep rise. The Association has been licensed to operate an employment bureau, which has already proved its worth. The Statutory Meeting of the N.R.E.A. has been provisionally fixed for September 11th. Full particulars can be obtained on application to the Hon. Secretary, 114, City Road, London, E.C.1.

Happy Event

WHEN a pearl grey, plumpish cat miaowed for permission to set up housekeeping recently at KGPL, station of the Los Angeles Police Department, she meant business, says the American amateur radio journal, "R/9."

Before officers and operators could decide upon a name for tabby, the stork had come and gone; a "blessed event" had occurred right in the transmitter room. The new arrivals were duly christened *Cathode* (Katie for short), *Anode* (Annie for short), and *Static* in remembrance of their birthplace.

More High Power Stations for U.S.

HALF a dozen American medium wave broadcasting stations may be using a power of 500 kilowatts within the next six months, following the success attained by WLW, Cincinnati, which was given a special "super-power" licence by the Federal Radio Commission a year ago. This station, owned by the Crossley Radio Corporation, is reported to have increased its "coverage" by some 300 per cent. without interfering with other transmitters.

The natural sequel is that other station authorities are petitioning the F.R.C. for similar concessions and, according to a correspondent, it is probable that a revision of the existing radio regulations will be made to allow selected stations to increase their power.

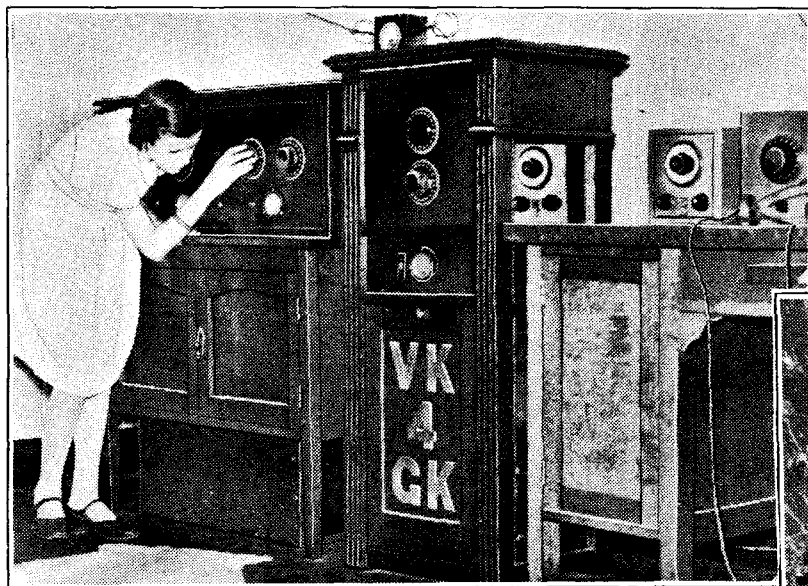

Lille-Camphin (60 kW) started working on August 23rd, and the new Paris-P.T.T. station (90 kW) on August 25th. The 120-kW transmitter at Villebon will continue to work on this power until the end of September.

The Paris Show

EVERY year the Paris Wireless Salon receives a distinctive label according to the prevailing tendency which the exhibits will indicate, writes a correspondent. Two years ago it was the Salon of the Mains-Driven Radio, and in 1934 visitors flocked to the Salon of the Less Dear Set. This year it is the Salon of the Stabilised Technique.

The Salon opened yesterday (Thursday) at the Grand Palais, and will continue until September 15th.

clude demonstrations of radio direction finding at sea.

Ship installations ranging from apparatus for use on large passenger craft down to small yachts and trawlers will be shown on the stand of the Marconi International Marine Communication Co., Ltd. Echometers will be exhibited by the Marconi Sounding Device Co., Ltd.

The exhibition remains open until September 28th.

Police Radio Network

MORE than thirty radio-equipped police cars now patrol London throughout the night, all under the control of a central transmitter at Scotland Yard. The whole of the Metropolitan area has been divided into sections, so that no district is outside the "beat" of at least one patrol car.

BRISBANE'S RECORD. Queensland's capital claims the honour of having the Empire's oldest and youngest amateur radio operators, Miss Madeline McKenzie, aged twelve, and Mr. Philip Hardgrave, who is seventy-eight.

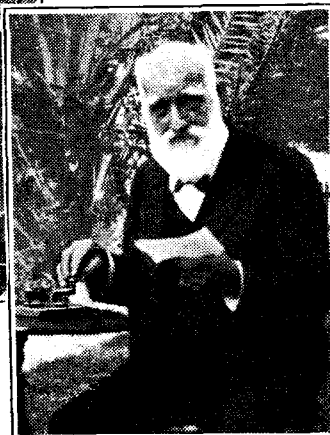

Australia and also New Zealand.

Miss McKenzie gained her certificate a few months ago, her marks in the operating section being 98 per cent. for sending and 96 per cent. for receiving. Her father has been a keen amateur for fifteen years; the whole family, indeed, is "radio conscious," for Mrs. McKenzie and two sons, aged ten and eight years respectively, can all read Morse.

Fishy Business

THE owner of a floating radio store has just visited London. He is Mr. Davidsson, of the Faroe Isles, who tours the islands with a launch carrying

Loud Speaker Progress at Radiolympia

Impressions Recorded
During a Tour in
Search of Quality

By M. W. NORMAN

THE author finds a more satisfactory compromise between the ideal and the practical in loud speaker design and indicates where future improvement is likely to be found.

SO much attention is directed to the radio part of a receiver that the experimenter is apt to look upon the loud speaker as something merely to be taken for granted. One is apt to forget that the results from a well-designed set will be marred by an indifferent loud speaker. Also it is well to bear in mind that a good loud speaker will paint an indifferent set in its true colours—funereal at times and grizzly at others. A few years ago quite a number of speakers were of the reed-driven type, but these have now given way to the moving coil. The first cheap commercial models of moving-coil speakers were not really pleasing to an ear which likes good quality. As time has progressed, manufacturers have steadily improved their products and

give a much better product than he is to-day.

We were tickled to death by the gentleman who was on the hunt for a speaker at Olympia. He went up to a stand when an item was being announced, and, turning round to the writer with a look enough to freeze mercury, said: "That's nothing like a human voice; why don't they design instruments which will give reproduction a semblance of reality?"

The "Giant" Announcer

Unfortunately, the "giant" announcer did not impress the listener as being symbolic of reality from any loud speaker in the main hall at Olympia. The output level from the loud speakers in the main hall was a good 15 to 20 decibels above that of the normal voice, whilst during the reproduction of music there seemed to be distortion, presumably due to an imperfect input (even with broadcast items) and also due to the acoustical properties of the hall. It is extremely disconcerting when one is discussing business or technical matters to have a *noise* level of some 80 decibels most of the day. We suggest that next year's Radiolympia might be free from *noise*; in fact, a silent harbinger of *quality*. It would probably deprive the sensational Press of the lurid and alluring headlines to which we have long been accustomed, but a great benefit would be conferred upon the public at the Show, and afterwards in their own homes. The time has surely arrived—thirteen years

after the inception of broadcasting—for the public to be permitted to buy sets which will give good quality.

So far as loud speakers are concerned, quality is rather fickle, but it is on the upgrade. Last year there was a tendency to increase the frequency response range from 4,000 c/s upwards. This year this tendency is more pronounced, although it is problematical if a wide range will ever be achieved satisfactorily with a single diaphragm. There are many points in speaker design which are concerned with quality. Stronger magnets invariably help, and this year another new alloy is

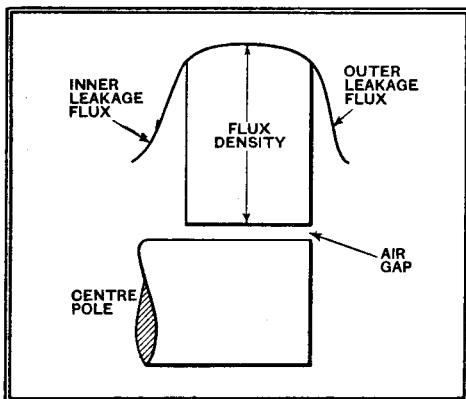

Fig. 1. Curve showing distribution of flux in air gap of speaker magnet.

evolved methods of economic and accurate manufacture. There is no doubt that if set manufacturers would spend a little more money on providing better loud speakers then quality would improve all round. One set manufacturer has paid a good deal of attention to distortion due to cabinets, and this is an excellent precursor to better reproduction. Would it not be preferable for all manufacturers to come to an agreement that next year's set models should be 10 per cent. or 20 per cent. dearer, the extra cost being entailed by a better loud speaker and an improved output stage to correspond. So long as pentodes are used the amount of distortionless output must be somewhat limited. We suggest that a loud speaker which costs the set manufacturer not less than 28s. would be satisfactory. If large quantities are used the loud speaker manufacturer would be in a position to

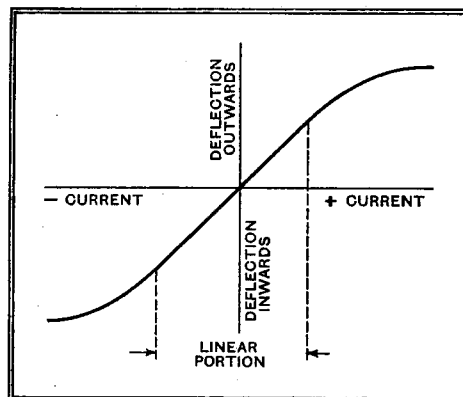

Fig. 2. Current/diaphragm-displacement curve of moving-coil loud speaker.

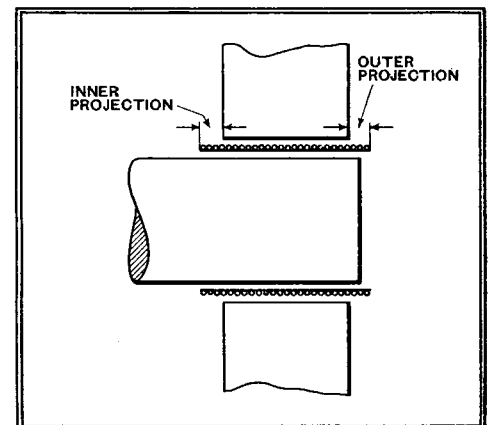

Fig. 3. Amplitude distortion can be to a certain extent overcome by making the coil longer than the air gap.

to the fore. At the 1934 Show the magnet manufacturers introduced the light-weight alloy "Alni," which is composed of aluminium and nickel. This year, after further research, an even better alloy has been produced by the addition of some cobalt to the above alloy. The same volume of metal gives a greater flux density, although the price is somewhat greater owing to cobalt being an expensive ingredient. Alternatively for the same price as a last year's magnet the volume of metal is less. Where energised magnets were used there was invariably a hum-bucking coil wound over the pole piece just outside the main field coil. This is connected in series with the speech coil. It provides an e.m.f. in opposition to that induced thereon by the 100 c/s. AC from the rectifier which passes through the

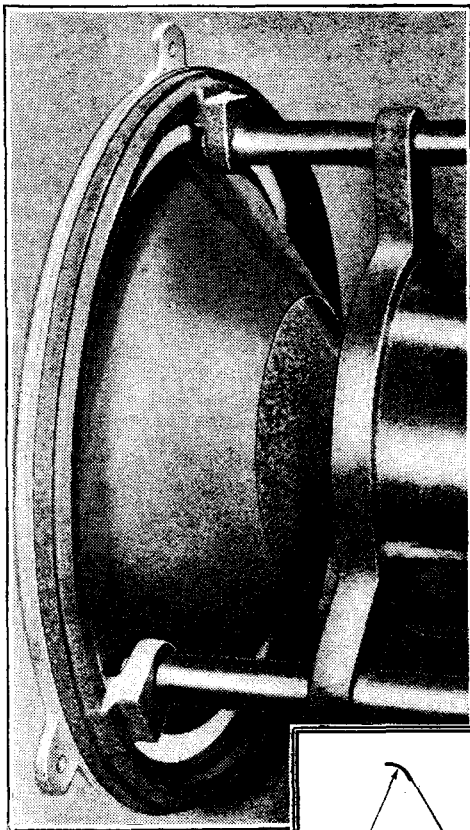
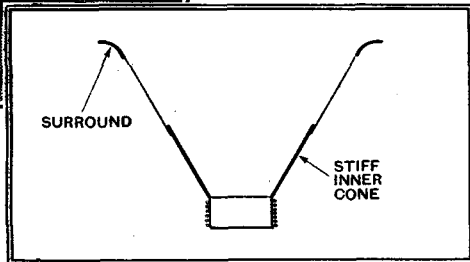

Fig. 4.—The centre portion of the cone in the Epoch "Domino" loud speaker is of stiffer material than the main cone, the two elements being cemented together as shown in the sketch.



field coil. With a sensitive speaker, where the total gap flux is 160,000 lines or more, it is essential that the AC from the rectifier should be reduced to the smallest possible amount. This is particularly the case if the speaker is to be used in a room, one of whose resonant frequencies is in the neighbourhood of 100 c/s. Hum frequently collects in corners and annoys couples who sit out dances!

Centring devices seem to have had a good deal of consideration, and these give greater freedom of axial movement and less tendency to non-linear action than their predecessors, *i.e.*, to the creation of higher harmonics, especially when the amplitude is large at low frequencies. In

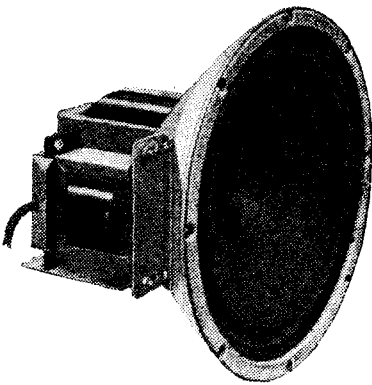

Fig. 5. A curved cone diaphragm is employed in the Magnavox Model "Thirty-Three."

a number of speakers the small spiders within the cone and just at the front of the moving coil have been replaced by larger spiders placed at the rear of the cone. It is now fairly widely understood that a certain amount of flux leaks out of each end of the air gap in which the moving coil is situated, as shown by the curve of Fig. 1. If the coil is the same axial length as the air gap, it moves into the leakage flux or fringe during operation, especially at low frequencies where large amplitudes occur. If a direct current is passed through the coil and the deflection plotted against the current, the result is somewhat after the form shown in Fig. 2. Instead of being a straight line, the characteristic is curved. The result in practice is distortion, due to higher harmonics and frequency modulation. This can be obviated (to an extent) by making the coil longer than the air gap, as illustrated in Fig. 3. The coil must not be made too long or it will be

too heavy and the inductance rather high. Both of these reduce the high note output. Practically every manufacturer has introduced this scheme, and where coils were visible they were seen to project beyond the front and rear faces of the outer pole piece about $\frac{1}{8}$ to $\frac{3}{8}$ in. Various arguments can be advanced against the publication of acoustical response curves of loud speakers. There is no doubt that the conditions in practice make curves taken in "dead" rooms or in the open air difficult to interpret with any degree of certainty. But at Radiolympia 1936

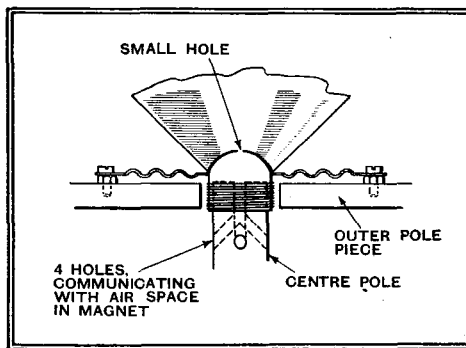

Fig. 7. Diagrammatic section of Film Industries unit showing dust-proofing arrangements.

too heavy and the inductance rather high. Both of these reduce the high note output. Practically every manufacturer has introduced this scheme, and where coils were visible they were seen to project beyond the front and rear faces of the outer pole piece about $\frac{1}{8}$ to $\frac{3}{8}$ in. Various arguments can be advanced against the publication of acoustical response curves of loud speakers. There is no doubt that the conditions in practice make curves taken in "dead" rooms or in the open air difficult to interpret with any degree of certainty. But at Radiolympia 1936

it would be very heartening to see every manufacturer publish a curve showing the relationship between direct current in the moving coil and deflection. This would

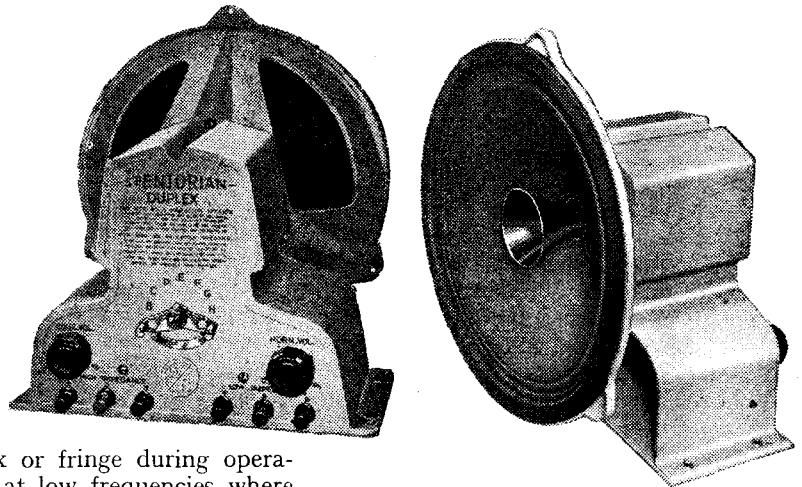

Fig. 6. A horn-type tweeter is incorporated in the Stentorian Duplex loud speaker and separate volume controls and matching transformers are associated with each unit.

give intending purchasers an opportunity of knowing the travel of the coil over which the action is linear and harmonic creation a minimum. The shape of the curve would take some such form as that illustrated in Fig. 2.

High Frequency Response

Coming back to the problem of extending the range above 4,000 c/s, various devices have been adopted to achieve the desired result. In the case of cones moulded from paper pulp, the centre portion is dipped in a solution which increases the rigidity when dry. The doped portion extends to a radius of $1\frac{1}{2}$ to 2 in. In one case the cone is made in two parts, the paper at the

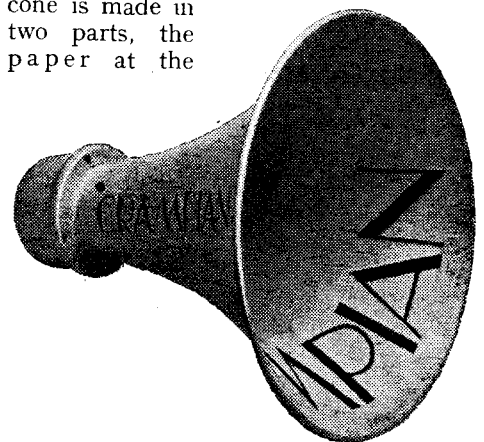

Fig. 8. Grampian public address loud speaker with short directional horn.

centre portion being stiffer than that at the outside. Exponentially shaped cones are also being used. Here the angle at the apex is much smaller than that at the base of the cone and the high note response is said to be improved. Another point in connection with the stiffened centre is the reduction in the focusing of the higher audible frequencies. The

Loud Speaker Progress at Radiolympia—

larger the radiating surface the greater is the focusing or searchlight effect. By using a small surface at the centre for the higher frequencies they spread over a greater angle, thereby giving better distribution and improved reproduction of transients for listeners not situated near the axis of the cone. Another point about these improved diaphragms is the reduction of the resonance peaks above 2,000 c/s. There are resonances undoubtedly, but they are less conspicuous than in the older type of diaphragm. One manufacturer has ingeniously combined a moving-coil hornless speaker and a horn tweeter in one unit. There are two air gaps: one at the front for the cone unit, and the other at the back for the horn unit. The horn projects through a hole in the centre pole, as shown in the photograph in Fig. 6.

It is well known to loud speaker manufacturers that, when testing cones using a

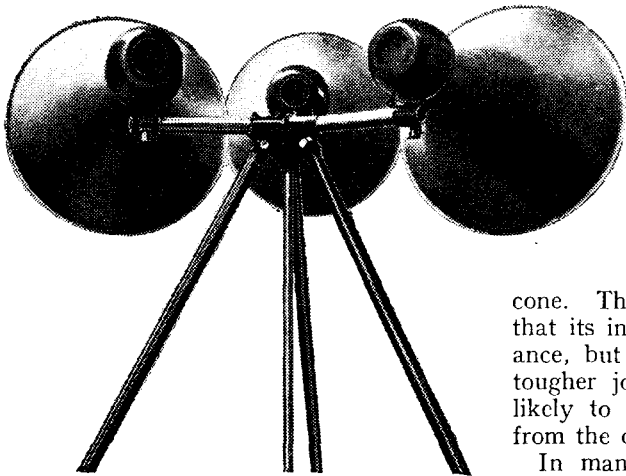

Fig. 9. Adjustable tripod mounting for the R. & A. horn-type public address loud speakers.

pure tone variable frequency oscillator, sub-harmonics occur. For instance, if about three watts or so is fed to a moulded paper diaphragm at 2,000 c/s, there may be a tone of 1,000 c/s present, *i.e.*, a sub-harmonic which is very noticeable. Below a certain input the sub-harmonic will not occur. The Telefunken Co. in Germany claim that the tendency to the

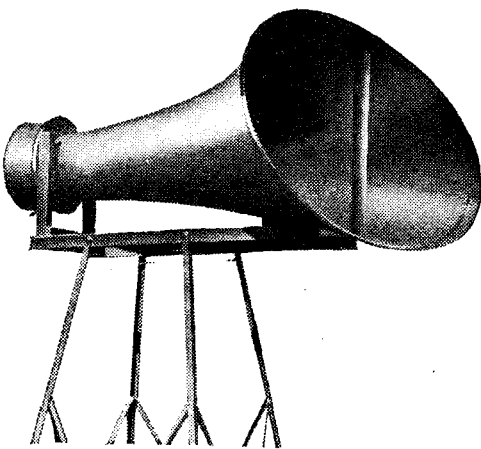

Fig. 10. Sound Sales directional baffle with elliptical aperture giving improved radiation in a horizontal plane.

occurrence of sub-harmonics is much reduced, but not eliminated, by using a curved-sided cone. Many straight-sided cones nowadays are made with circular

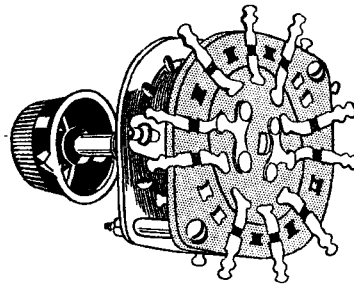

Fig. 11. Wharfedale "Truqual" constant impedance volume control.

corrugations which alter the frequency intervals between and the height of the resonance peaks as compared with a straight-sided cone. These corrugated types are found to be less prone to sub-harmonics than the plain cones, but not so free from them as the curved-sided variety. The tendency for sub-harmonics to occur is reduced also by using thicker paper. There seems to be a diversity of opinion on the influence of a seam on the acoustical performance of a cone. The general opinion, however, is that its influence is of secondary importance, but that a curved seam enables a tougher joint to be made, which is less likely to come adrift with large output from the diaphragm.

In many speakers, particularly those with permanent magnets, the clearance between the moving coil and the pole faces is extremely small. Experience during the past few years has shown that if the performance of the speaker is to be maintained it must be free from particles of dust, particularly that of metallic origin which is rife in factory stores, or where the speakers are used out of doors for public address work. Consequently, a number of manufacturers displayed dust-proof speakers in which the moving coil and the air gap were almost hermetically sealed from the outer atmosphere.

Public Address Units

In public address speakers the prevailing practice is the use of metal horns about 2ft. to 3ft. long in conjunction with a moving-coil paper cone unit, the cone being about 6in. in diameter. These speakers with horn openings of about 30in. diameter are very useful for public address work owing to the high efficiency and directional properties. A number of such speakers are used when a large area is to be covered, and to this end a skeleton framework or tripod mounting several speakers which can be oriented both vertically and horizontally have been designed.

Extension speakers have been a source

of annoyance at times owing to difficulties in impedance matching and volume control. It is rather exasperating when an extension speaker fitted in the servants' quarters gives forth much more sound power than that in the drawing room, even when the set is going flat out! Several manufacturers have overcome this defect by providing special volume controls which do not upset the matching appreciably.

Apart from extension speakers some manufacturers provide a variable ratio

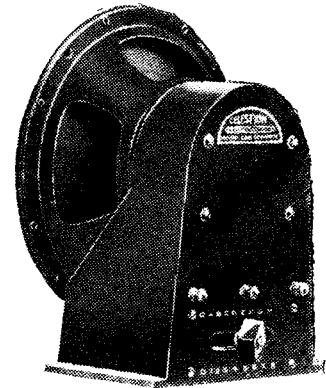

Fig. 12. Celestion Standard 8 extension speaker with multi-matching and volume control.

transformer, by means of which a very wide range of impedance matching can be effected so that the speaker will fit almost any set. In one case there is also a special form of volume control combined with the impedance matching switch.

Although the reproduction from loud speakers is still imperfect, there is no doubt that the exhibits at the 1935 show indicate a desire on the part of manufacturers to improve their products. The ratio quality/price is increasing, and it is to be hoped that this will continue.

**A Survivor of the
Quetta Disaster**

This W.B. speaker, after surviving several sandstorms, came unscathed through the recent Indian earthquake—searching tests of the efficiency of the precautions taken for excluding dust.

A Briton in Berlin

The Two Radio Shows Compared

THE main difference between the London and Berlin radio exhibitions is that between propaganda for radio and radio for propaganda. Olympia was the shop window of the British radio industry; Berlin's show was a great Government push (or is it "putsch"?) with the full weight of the Nazi State behind it. Small wonder that Berlin, in size and its mass attendances, eclipsed Olympia.

But, superficial as the view may be after three short days, I left Berlin with a feeling of great pride in our British industry, for I could see no respect in which Germany was technically superior. The Nazi State can produce more impressive exhibitions, but it cannot produce better wireless sets. Indeed, in several respects, I think Britain is ahead.

However, my main purpose is to contrast the two exhibitions. Berlin's great advantage is in its situation and general plan. The six main exhibition halls form a square round pleasant gardens, in the centre of which rises the 450ft. Witzleben television tower. Two other large halls are connected to these by an underground passage and an escalator.

Visitors may escape from the crowded halls into the gardens, have their meals at open-air restaurants, and, as a further diversion, ascend to the summit of the television tower to obtain a bird's-eye view of the city.

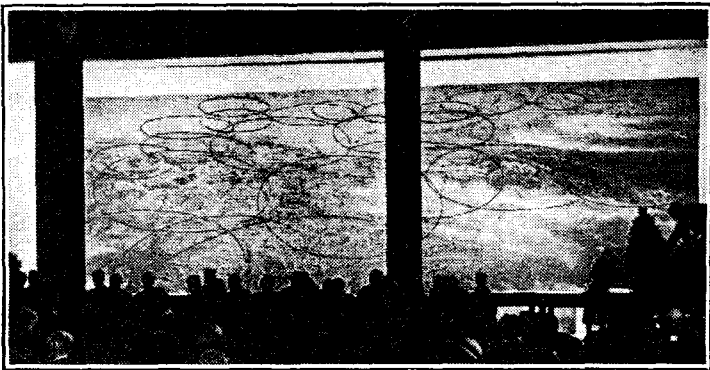

This photograph was taken during an actual demonstration of high definition television at the Berlin Show. In the background is an illuminated relief map showing the future distribution of Germany's television transmitters and their service areas.

Sets were not demonstrated in Berlin any more than at Olympia, and presumably for the same reason. On the other hand, Berlin was much more of a broadcasting exhibition. The effort of the State broadcasting organisation was prodigious, and amounted to moving the inside of the Rundfunkhaus into the exhibition buildings in order that the public might see the inner working of radio. Practically all the broadcasting from Berlin during the show week was done from these glass-panelled studios in the exhibition halls.

It was the boast of the organisers that any member of the public might qualify

By a Special Correspondent

Members of the German Work Service who provided a speaking and singing choir for the gala programmes broadcast from the Exhibition.

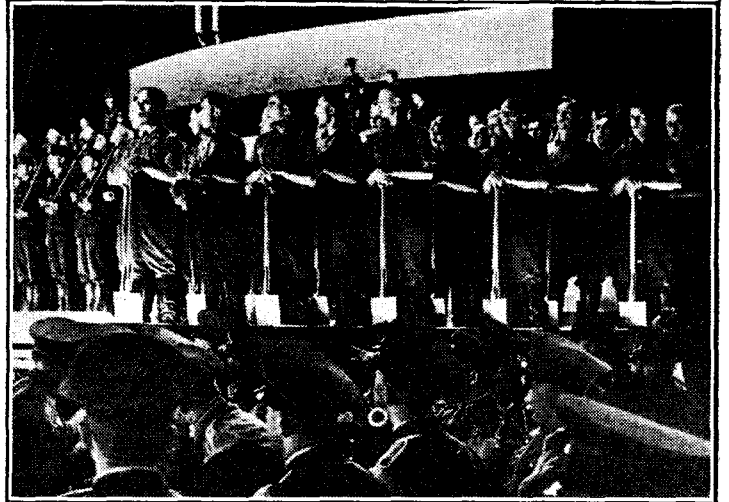

to broadcast, but investigation proved that there were several catches in this theory. In the first place, it was necessary to prove oneself a true-blooded Aryan, and in the second that one would say nothing bad about the administration. After that, the procedure was to enter a little cubicle studio, of which there were twenty, and have one's voice recorded on a disc. Later, the authorities were supposed to play over the records and decide which voices were suitable for broadcasting. An invitation to the microphone in a few cases followed.

All this trouble—there were about 3,000 auditions a day—was taken simply as a gesture to the public to give them the feeling, however illusory it might be in

dering whether there was any fundamental difference. The B.B.C. view seems to be: "Give the public what we think they want." The German: "Let the public think we are giving them what they want."

Local choral societies and orchestras from all parts of Germany, the members wearing their picturesque peasant costumes, broadcast from the Berlin exhibition. To the foreigner the spectacle was a delight. How the programmes appealed to German ears I have no idea. Here, again, the contrast with London was violent. Established radio artists occupied the stage at Olympia, and, indeed, so certain are the organisers that this is what the public want that many items were repeated from last year.

Television Demonstrations

Undoubtedly a large section of the crowds in the Berlin exhibition had been attracted by the television exhibits. The proximity of the Witzleben transmitting tower, however, placed the exhibitors in a privileged position. Demonstrations of reception by wireless link could be given without any difficulty. Imagine the difference if Olympia exhibitors had had a 450ft. transmitting tower where Addison Road Station is. But, disregarding for a moment the obvious interest in the television demonstrations, it might easily be argued that the German manufacturers have been premature in marketing commercial models while the Witzleben transmitter is still working on 180 lines and twenty-five pictures per second. A higher definition is bound to be adopted shortly, and whether it will be 240 or 320 lines seems a little uncertain.

I had the impression that the Nazis discouraged listening to foreign stations, but discovered that there were hundreds of sets on view comparable to our popular four- and five-valve superheterodyne models, with all Europe's chief stations marked conspicuously on the dial. However, it

reality, that the broadcasting machinery belonged to them—in other words, to convince them that German radio was of the people, by the people, for the people. The idea is somewhat reminiscent of America's amateur hours. I do not imagine for a moment that either scheme discovers much hidden talent.

The B.B.C. is supposed to be pondering a means of "popularising" itself. I have tried hard to visualise a similar "hands-across-the-ether" effort by the B.B.C., and must confess that it seems incredible. An immense amount of work was put into the Olympia theatre, but the conception was different. I am still won-

A Briton in Berlin—

may be that price was the deterrent, for in some cases sets seemed to cost about twice as much as at Olympia, and I saw no evidence of money to burn among the visitors.

More Sets at Olympia

There is no doubt that a wider range of sets was shown at Olympia. Here, again, there was a different motive at work. British manufacturers aimed at extending their clientele by catering for every purse and every type of listener. The totalitarian State wants every household to listen; the nature of the apparatus is a secondary consideration. Consequently, all German manufacturers are still making in immense numbers the

simple two-valve "People's Set" sold at about £6—a set designed in 1932.

Now a large new receiver for communal listening in factories is being turned out. I cannot think that this policy encourages technical progress.

From the point of view of layout, the main difference between the two exhibitions was that, whereas the Olympia stands are mostly islands, those in the narrower Berlin halls were ranged against the walls. Each stand had its own private rooms where clients could be interviewed and entertained. There was no general exhibitors' club.

In general, it would seem that, though the two exhibitions are held simultaneously and are devoted to the same science, they have little else in common.

Tuning Superhets

Novel Oscillator Coupling

THE problem of tuning the signal and oscillator circuits in a superhet in such a way so as to combine efficiency with simplicity, calls for some ingenuity, and many efforts have been made to solve it. The solution illustrated is one of the latest.

The grid coil L, Fig. 1, of the mixer valve V is divided into a number of sections, which are connected to the segments of a commutator switch, S, so as to bring one or more of them, as desired, across a single tuning condenser C. The coil is wound, as shown in Fig. 1a, on a low-loss former, which also encloses the anode coupling - coil L₁. The latter is wound on a different diameter, and is arranged to be movable to and fro along the major axis. In this way the initial coupling is varied until it offers minimum impedance to the signal and local-oscillation frequencies at all settings of the wave-range switch S. At the same time the amount of back-coupling, which is kept constant over the whole range of the tuning condenser, is sufficient to increase signal strength without running into self-oscillation other than at the local-oscillation frequency.

The arrangement of the plate circuit is also worthy of notice. The path containing the condensers C₁, C₂ has a sufficiently low impedance to allow unwanted frequencies to escape to earth. A second

path, containing a fixed condenser C₃, the back-coupling coil L, a semi-fixed condenser C₄, and a trimmer C₅, has a "lumped" impedance which blocks out the intermediate frequency, but offers less impedance to the signal and oscillator frequencies than does the path C₁, C₂. These oscillations are therefore passed back into the grid circuit for further amplification, whilst the resulting beat frequency is filtered out at R and passes to the IF amplifiers.

The plate coil L₁, it should be noted, is so tightly coupled to the grid coil that

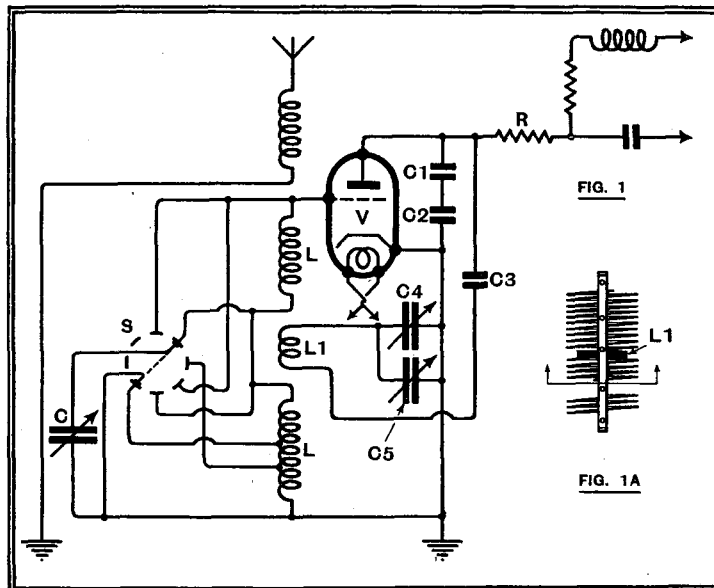

Fig. 1.—Simplifying the tuning of the frequency-changer.

it is automatically tuned by the main condenser C. Under these conditions a correct setting of the condensers C₄, C₅ allows both the signal and local oscillator frequencies to pass through the plate coil L₁ back into the grid circuit, for further amplification and mixing.

Technical Language

By "CATHODE RAY"

THERE must be many a reader who is technically inclined, in the sense that he is interested in valves and loud speakers as distinct from crooners and Dancing Daughters, but whose budding courage is apt to be blighted when brought in contact with the books and articles on which his interest hopes to feed and expand. There is a flood of strange, presumably learned, language accompanied by mysterious letters, perhaps even mathematical symbols, and certainly many diagrams that make the Hampton Court maze look like a tradesman's entrance.

Even when the words themselves are familiar they are used in unfamiliar ways and senses. All this literature would be very instructive, no doubt, if one could only understand the language. But the constant recurrence of technical terms and expressions creates a feeling of bewilderment that forces one to the conclusion that "this is no place for me." It cannot be anything I am capable of understanding. And so on.

Well, of course, radio is a very highly technical subject. And there are some books and papers that are intended only for professional scientists and engineers, who are expected to be able to follow them. Not that they always do: I remember being near an eminent Professor of Electrical Engineering at the reading of a paper before one of our engineering institutions and overhearing him whisper to his neighbour that these things were getting far beyond practical understanding.

But *The Wireless World* is not of that sort. Nevertheless there are quite a lot of articles in it that are apt to be a bit of a staggerer to novices. Now this is not a prelude to announcement of "The Wireless Fan's A.B.C." or "How to Learn Radio in Half an Hour." To become really proficient in *any* subject—wine-tasting, for example (so I am told)—necessitates a good deal of application.

But it seems that the presence of even a few quite easy though unfamiliar terms often has a frightening influence out of all proportion. Every trade has its own technicalities and abbreviations that sound mysterious and exclusive to the uninitiated, but they do not necessarily betoken a high degree of intelligence.

When people are talking their own technical language to one another it may sound like a conscious effort to be highbrow. But usually it is nothing of the kind. To them it is perfectly natural and straightforward, and they might well be surprised and grieved at a charge of intellectual snobbishness. That is why it is so difficult for these people to express themselves intelligibly to the beginner.

Technical Language—

Technical terms apart, the scientific or academic writer, as distinct from the popular or amateur, has quite a characteristic sort of language by which he may be easily identified. It sounds very pedantic and stilted to those who have never been in that sort of atmosphere, but it isn't consciously so. The most characteristic expression, used very freely, is "in general." Other favourite words are "consider," "determine," "deduce," and "in the order of." It is really quite harmless, and may go sometimes to ludicrous lengths. My old chemistry professor was pointing out to us that the gas inside a flask was dark. He didn't say it was dark. He said it was "tolerably intensely coloured internally."

Initial Abbreviations

But to get back to the sort of language that may be found in these pages. One thing that "looks like Greek" at first glance is the general use of abbreviations—HF, DC, AC, LT, AVC, GB, etc. This is made rather more puzzling than it need be in wireless literature by reason of lack of standardisation. Some authorities put "HF" and others "RF," and so on. But it is not a heavy job learning them because there are less than a dozen that matter. They all stand for things that are in such constant use that it would be tedious to write them out fully or to say them every time. In fact some have so completely supplanted the words for which they stand that the original meaning has been forgotten, and we get absurdities like "DC current" (direct current current) and now "IF frequency" (intermediate frequency frequency) and "AVC control."

Another thing that looks wise but is

really foolish is the way valves are named. The innumerable combinations of letters and figures appear to have some deep and esoteric meaning. And the makers may tell you they have. But when substantially the same type of valve is denoted variously by AC/HF, 41MHF, TE.244, D4, AC/HL, MH4, HLA2, 354V, SS.4.GPAC, A430N and AR.4101, one may well enquire who, guided merely by common-sense, would suppose them to be the same in most things except factory of origin.

So there is no need to pay much attention to them except as a sort of arbitrary reference.

Then there are the real technical terms that are never found elsewhere; some of them uncouth words like superheterodyne, pentagrad, dynatron, oscillograph. There are not so very many of *them* that really matter. Wireless dictionaries have been produced at a low price to help one here. They may not give a complete explanation of the articles in question, so that the reader could forthwith set about and make one; but they at least give some clue as

to what the fellow who uses them is getting at.

The real rub is not the outlandish words but the harmless looking ones. An unfamiliar appearance gives warning of something new, but when ordinary words are used in a special sense there is the possibility of confusion. When talking to the complete layman—or woman—who asks questions, I have a very difficult job trying to avoid such terms as signal, tuning, interference, screen, noise, speech, earth, capacity, cycles; for they all carry meanings in the minds of the listeners that only confuse them when they hear them used technically. Some of these special wireless meanings have by now become current among all, except perhaps occupants of the Bench, but others still give a lot of trouble. It is here that the writers of "wireless-made-easy" books have to be at great pains to erase from their minds all their training and upbringing in the special use of words, and readers of technical matter must be on the lookout for unfamiliar usage.

The Cathode Ray in the Motor Industry

A New Application to the Problems of Fuel Blending

NEW applications of the cathode ray oscillograph are of almost daily occurrence, but one of the most interesting which has recently appeared is in connection with the testing of petrol and oil fuels for internal combustion engines.

Many readers will already be acquainted with the fact that the "anti-knock" properties of fuels are becoming of increasing importance now that the car manufacturers are making an all-round increase in the

efficiency of their small high-speed engines. The standard method of test is to burn the fuel in a special type of variable-compression engine, the incidence of detonation or knocking being detected by an instrument known as the Midgley bouncing pin. This method, although accurate, is admittedly arbitrary, and while it indicates the highest compression which can usefully be employed with any given fuel, it gives little insight into the phenomenon of detonation.

At the Anglo-American Oil Company's Research Department at Vauxhall the cathode ray tube has been successfully applied to this problem and results of far-reaching importance have been obtained.

The voltage used to deflect the spot in the cathode ray tube screen is obtained across a compression-type resistance actuated by a small steel diaphragm let into the cylinder head. The type of resistance element employed gives a linear relationship between pressure and the volts developed, which are applied to give a vertical deflection. A normal time base circuit, triggered by a contact on the engine shaft, supplies the horizontal deflection. Due to the persistence of vision, a complete picture of the pressure variation throughout each cycle can be obtained, but the beauty of the scheme is that, by altering the time base, any section of the indicator diagram can be enlarged for detail inspection of transient effects, particularly those in the vicinity of the firing point. It is for this reason that the DC amplifier connecting the resistance element with the deflecting plates of the tube has been designed to eliminate all resistance-capacity effects with their associated time constants.

The same technique has also been applied to the investigation of the movements of the pintle in the spray jet of Diesel engines and has opened up new channels of attack on the special problems associated with this rapidly developing type of engine.

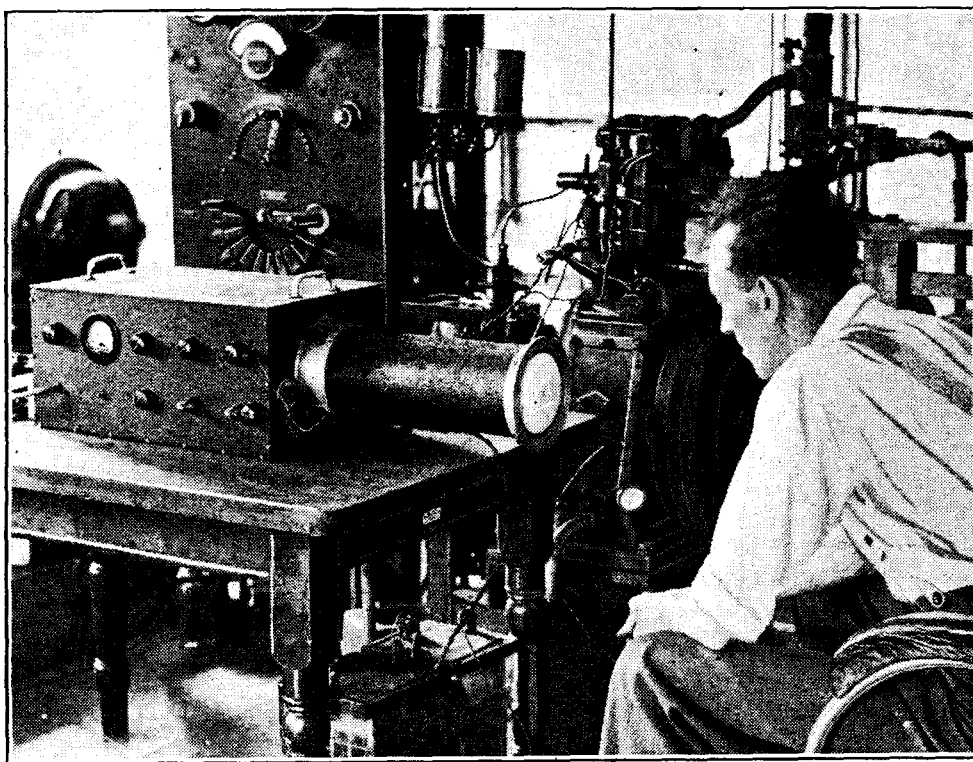

Experimental cathode ray equipment for investigating problems relating to internal combustion engine fuels.

Letters to the Editor

The Editor does not hold himself responsible for the opinions of his correspondents

Output Values

I AM not quite sure that I follow Mr. J. H. Owen Harries's reasoning (in the issue of August 9th) when he charges me with assaulting the standard of distortionlessness—the Class A triode. If he, or anybody else, cares to adopt it as such, it is not clear how I hindered him or them. What is quite clear is that Mr. Harries completely disagrees with my remark to the effect that the best part of the triode's characteristics are ruled out by the presence of grid current.

I have since taken the trouble to go into this question rather carefully, and as a result would slightly modify my original assertion, to read thus: "the part of the triode's characteristics ruled out by grid current is equal to the best elsewhere." As it seems likely that Mr. Harries will disagree with this hardly less profoundly than with the original, I proffer the accompanying diagrams. Fig. 1 shows a few of the

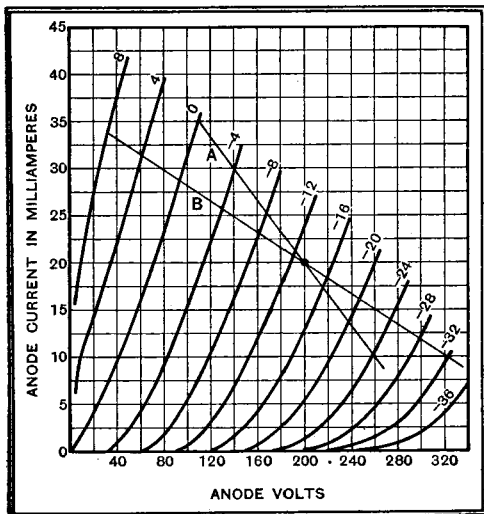

Fig. 1. Anode volts—anode current curves of an AC/P valve

curves taken with great care from an AC/P valve, which was selected as an example of an output triode with a rather high amplification factor, and therefore particularly suffering the limitation to which I referred.

The original diagram includes curves at every 2 volts from +10 to -36. Putting in the load line A for normal operation, one gets the following results:

Load resistance 5,000 ohms.
 Feed 20 ma. at 200 volts = 4 watts (neglecting slight rise under dynamic conditions).
 Output 0.54 watt.
 Efficiency .. 13.5 per cent.

Assuming that one could operate with positive grid voltages without grid current distortion, a load line B can be drawn as shown, up to +8 volts; and the results are:

Load resistance 12,000 ohms
 Feed as before
 Output 0.935 watt
 Efficiency .. 23.5 per cent.

The output and efficiency are nearly twice as great. And lest it be thought that this is, as Mr Harries says, "power output

without regard to distortion," it should be noted that the same standard was adopted, and that a greater output still could be obtained if a lower standard of purity were admitted.

To put this to the test specified by Mr. Harries himself, Fig. 2 has been derived. This gives the mutual conductance along the load line itself ($= \frac{M}{Ra + Rl}$) plotted against grid voltage. Curve B shows that it is not at all inevitable that the conductance should drop to a half at both ends of the optimum line. In fact, the proportionate drop is rather less than that of line A,

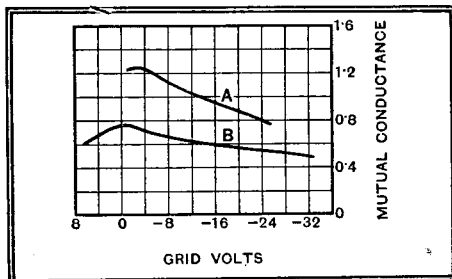

Fig. 2. Variation of mutual conductance with grid bias.

which relates to the mode of operation regarded by Mr. Harries as the standard by which all others are judged.

The point of the criticised article, however, is that a method is claimed whereby the absence of linearity, which is not negligible even in curve A, may be compensated. But that, as Mr. Harries says, is a subject too complex for the space available.

There may, however, just be space to include something that has no connection with the foregoing except that it refers to valve diagrams. It may be new to a few of the people who use them. In most valves, the magnification factor (μ) is little affected by operating voltages. To show up more clearly where and how it does vary, a very simple addition may be made to either anode or grid voltage diagrams (Fig. 3, a and b). Join together by lines all intersections between characteristic curves (assumed to be drawn at equal intervals of voltage) and equidistant verticals from the voltage scale.

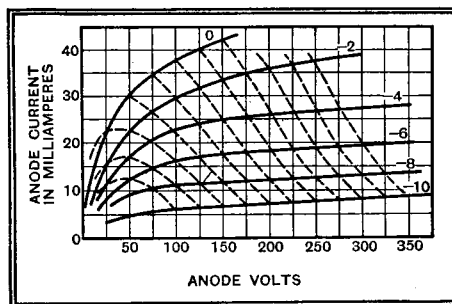

Fig. 3a. The bends in the dotted lines show the variation in μ .

The visible slope of the resulting lines depends on the intervals that have been chosen. If they are horizontal, and the intervals of grid and anode voltage are 2

and 10 respectively, then the factor μ is $\frac{10}{2}$, or 5. But the main idea is not to derive the actual number, but to see where the lines are of constant slope (and μ); and where they change, indicating variation of μ . The example, Fig. 3a, shows the

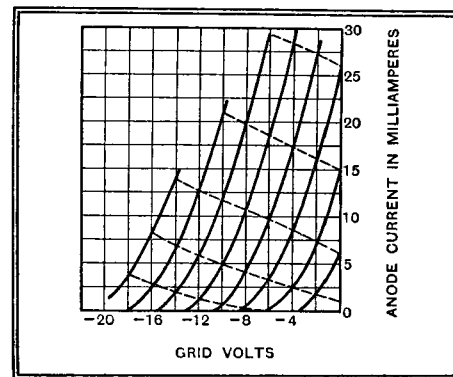

Fig. 3b. μ -lines may be drawn on the grid-volts—anode current curves.

region of inconstant μ in the region of the pentode knee, to which Mr. Harries refers. It is easy to see that where the slope of the line changes in an anti-clockwise direction a reduction in μ is indicated in the anode voltage diagram (3a) and an increase in μ in the grid voltage diagram (3b).

M. G. SCROGGIE.

Quality at the Show

MAY I be allowed to record my personal impressions of this year's Exhibition from the standpoint of the quality seeker? The arrangements made for the comfort and convenience of the public were markedly improved this time, but those who came to hear what progress had been achieved in loud speaker design must have been very disappointed. Apart from the obvious distortion that characterised the common amplifier performance, there was a preponderance of treble in the reproduction which was highly distressing. Not so long ago we were being regaled with the "boom, boom" of a fictitious bass: now, the pendulum has swung to the opposite extreme with a vengeance, and the result is all "tweet, tweet." Perhaps this is a step in the right direction, since in due course we shall arrive at the happier medium. But one realises that the seeker after quality has yet to travel a little farther before he can discover what he wants. Thin, high-pitched reproduction of music without adequate bass is very trying to the nerves, and if one does not want human applause to resemble the thumping of felt-covered mallets, yet there is no reason why it should be made to sound like the clicking of typewriter keys. It was a relief to hear in the Maclise Road demonstration room the natural reproduction of music given by the Voigt Domestic Speaker with its greater range of frequency response and comparative freedom from resonance. It seems fairly evident that the arrangement of supplying a large number of speakers from a common amplifier does not work satisfactorily in these days when the critical faculty of the public is reaching a higher standard, and that for future shows something better will have to be devised.

NOEL, BONAVIA-HUNT.
 London, N.W.6.

The Single Span Receiver

I BELIEVE that you welcome information from constructors as to their experiences with your Single Span Receiver, and I therefore wish to state that the Battery Single Span which I built in September last year is far and away the best receiver I have had both as regards quality and sensitivity, and selectivity is ample for all the worthwhile foreign stations.

The set compares very favourably with several of the more powerful mains sets I have heard, and indeed the quality on English as well as several foreign stations is decidedly better, due to the variable selectivity, and AVC is good on all but very weak stations.

The new aerial filter is a decided improvement on the original one, and the use of a

wave trap has completely eliminated heterodyne whistles. Kootwijk, 160 kc/s, is the only station which is spoilt by Morse, which is strong enough to violently agitate the tuning milliammeter, which I assume is due to some station just outside the long wave band.

We have a mains DC supply in this house, but my reason for choosing the battery set is to use it at times in another house without mains supply, but as it is mostly used here I have been considering the construction of another output unit which would be suitable for a D.C. eliminator.

I should like to take this opportunity of expressing my appreciation of the series of "Foundations of Wireless" which has been so clearly and concisely expounded by Mr. Sowerby.

L. DE SMIDT.
Tiverton, Devon.

Random Radiations

An AC/DC Year

THIS year the AC/DC set is to be seen here, there and everywhere at exhibitions or in wireless show-rooms. It is, when you come to think of it, about the soundest kind of apparatus to use in this queer country of ours where you may find AC mains on one side of a street and DC on the other. An almost incredible adventure happened to me this time last year in the pleasant little town of Southwold, in Suffolk. Before going there I enquired from the hotel what the current was and heard that it was AC; 230 volts, 50 cycles. I therefore took an appropriate set with me and plugged it in in my room. At the end of the warming-up period nothing happened, and from certain signs and portents I luckily realised that I was connected to a DC supply. The subsequent switching off was about one of the quickest things I ever did. On tracing out the wiring I found that just two rooms in the hotel, of which mine was one, were still on DC, though all the rest had AC. Fortunately the set was not damaged and gave a good account of itself when connected to its proper supply.

Is It As Good ?

In former years it was probably advisable to buy an AC mains set rather than an AC/DC model if you were already on the alternating current mains and were unlikely to move to a district blessed (or the reverse) with direct. On A.C. mains the performance of a genuine AC set was at that time considerably better than that of the AC/DC. This year so much progress has been made with the "universal" model that there is less to choose between the performances of the two kinds of sets on AC mains, providing that both are of equally good design. One firm, in fact, is now making nothing but AC/DC sets in its new season's models. One of the big advantages of this kind of set is that if you take it on tour with you you can always be sure that it will function no matter where you may be—unless, of course, you strike something like DC at 100 volts or 150-volt 25-cycle AC!

The Little Nationals

EVER since the B.B.C. was forced through shortage of wavelengths to synchronise the London, North and West

By "DIALLIST"

National transmitters on 261.1 metres and reduce their power from 50 to 20 kilowatts apiece I have been receiving complaints about poor reception of these stations, sometimes at remarkably short ranges. These smaller Nationals have now very limited radius for their service areas in certain directions. It seems a pity that the change had to be made, but I suppose that there was no way out of it. In some instances Droitwich provides the necessary reception of the National programme, but this is not the case in large parts of the west country where the reception of Droitwich is unreliable and the West National is distinctly difficult to hear at all well. It is rather curious that in some parts of this country several foreign stations are much better heard than those of the B.B.C.

The Micro Waves

BEFORE very long we may hear the results of the many months that Marchese Marconi's technical assistants have spent in research work upon micro wave problems. It is, though, probable that Marconi will have some particularly interesting announcements to make about the results which he has obtained with waves of very small length. Some extraordinary interesting work has recently been done in America on wavelengths as small as 73 centimetres, or about 2ft. 6in. Using the minute acorn tube, communication has been maintained by members of the Nassau Radio Club, of Oceanside, Long Island, at ranges of up to twelve miles, with complete intelligibility of voice transmissions up to ten miles. The power output of the transmitters was tiny, and it is possible that much greater ranges may be obtained with higher power.

The other day I was talking to an experimenter who was dying to be able to afford the time to conduct some researches into what one may term the border-line wavelengths; those, that is, which are so short that they are on the boundary between wireless waves and heat waves. Just where this boundary lies—at what length waves pass from the purely wireless category into the heat class—no one can yet say. This part of the wavelength scale is almost unexplored, and it may have some

big surprises in store for us in the future. Border-line waves must exist, but whether they can be harnessed to the service of mankind and what they will do if and when they are so harnessed are still profound mysteries.

The McNeil Invention

EXPERTS who attended the demonstrations of Commander McNeil's apparatus, which enables man to "see" in the darkness, or through fog, were very much impressed both by what they witnessed and by the possibilities of the invention. Commander McNeil makes use of an infra-red beam, which is, of course, completely invisible to the unaided eye. He has developed a "detector" so efficient that there is no appreciable lag between the picking up of a target and its becoming visible to the eye of the observer. The invention has astonishing applications to travel by both sea and air. Ships can find one another's position in the thickest weather. At the present time, when sound signals alone are used, this is a matter of extreme difficulty, for one of the unpleasant curiosities of fog is that the noise of a siren appears to come from no particular point or direction. It should be possible to "sight" icebergs when they are some distance away and a ship provided with the infra-red ray apparatus should have ample warning of rocks or other like dangers ahead. When one thinks of the number of appalling disasters at sea that could have been prevented had such apparatus been available, its usefulness becomes at once apparent.

Last, but almost supremely important, it may enable a navigator to take sights with the sextant and to find his position when the sun is not visible to the eye.

The Coming of Autumn

THAT autumn is approaching is strikingly brought home when one handles a receiving set towards evening just now. A few foreign stations on the medium waves such as Brussels No. 1, Cologne, the Poste Parisien and Fécamp provide daylight reception in many places all the year round; but most of them do not make their appearance until rather late in the evening in summer time. The number receivable at dusk or rather before is increasing rapidly just now.

In summer those near the top of the medium-wave band are often quite poorly received even late at night. Some of them are now moving fairly quickly towards their winter form, and before long they should all be back in the list of stations upon which we can rely for good alternative programmes evening after evening.

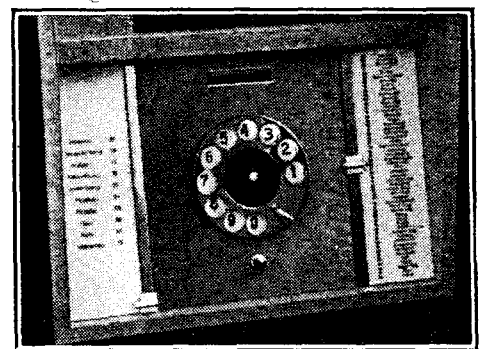

We could spend hours playing with the telephone dial tuner of the Neufeld and Kuhnke receiver seen at the Berlin Show.

Listeners' Guide

Outstanding Broadcast at Home and Abroad



"FRIDAY THE THIRTEENTH," the play to be broadcast on Wednesday and Friday next, is based on the famous Gainsborough film of the same name, from which the above pictures are taken. An accident to the 'bus is fraught with remarkable consequences, as Lance Sieveking's radio adaptation will reveal.

TIGER STILL STANDING

TIGER STANDISH is having "a heck of a time." Tonight's episode in his hue and cry for the evil machinators takes him to Rome, where he has not only to cope with the criminal fraternity but with poetry of this kind: "Seven men in seven places, Seven cafés, seven faces." If the Tiger escapes from Rome he should reach the Café des Nations at Monte Carlo on Thursday next (Regional, 8.15).

By the way, to-night's adventure should see the return of Walford Hyden, who has rapidly progressed since his operation for appendicitis and who is expected to conduct the Café Colette Orchestra again. Actually, while recovering, he has been arranging the music for this popular feature.

BOMBING ATTACK IN MUSIC

THE week's musical novelty is "Suite from Film Music—1935," by Arthur Bliss, included in the Promenade Concert broadcast of Thursday (National, 8). The Suite is a selection from the incidental music to the new H. G. Wells film, "Whither Mankind?" founded on his novel, "The Shape of Things to Come."

The universal world war foretold in the novel is portrayed in the music, which is in seven short movements. After a prelude which accompanies the sequences of the

film showing the menace and anarchy of war, the scene changes to a children's nursery. Mobilisation for war, a night bombing attack, and the world in ruins are musically portrayed in the fourth, fifth, and sixth parts of the Suite. The third movement is an idyll of pastoral peace in the reconstructed world, and the seventh states the theme of reconstruction itself.

The composer will himself conduct the Suite, and we may expect as faithful a portrayal of death and destruction as is in the power of modern music to inflict.

ON THE MOORS

THE atmosphere of the grouse moors, I hear, permeates the programme of the "Air-do-Wells" for September 9th and 10th, and Ronald Hill has written a new number entitled "Huntin', shootin' and fishin'." Effie Atherton and Margery Wyn will again be heard, and a newcomer to the microphone will be Gavin Gordon. Marjorie Stedeford, the Australian star with the deep voice, is also singing two special numbers.

'BUS SMASH

How a single dramatic experience—an accident to a London omnibus—affects and diverts the life of the participants is the theme of "Friday the Thirteenth," the radio play to be given in the

National programme on Wednesday next at 8.30. Lance Sieveking has, in fact, made an adaptation of the Gainsborough film of the same name. In the film eight separate groups of characters each

had their separate stories, but for the radio version it has been found necessary to eliminate some of these, and to simplify the narrative.

The part of Alf, conductor of the fated 'bus, will be taken by Lance George. Bertha Woolcote plays Miss Twiggs, and Lauri Lupino Lane is her nephew.

There should be great scope for the Effects Department in this thrilling play.

THE LAST BOW

MR. EUSTACE ROBB has collected an outstanding cast for that rather melancholy event, the final 30-line television transmission, on Wednesday. Lydia Sokolova, the prima ballerina of the late Diaghileff Russian ballet, will pirouette for the last time in the 30-line flicker, and Olive Groves,



FAREWELL TO 30-LINE. Olive Groves (left) and Lydia Sokolova, two celebrated artistes who take part in the last low definition television programme on Wednesday night.



30-LINE TELEVISION

MONDAY, SEPTEMBER 9th.
11.15-12.0 p.m.

Barry Whitmore and Edna la Velle (dances); Skates Gardner (roller and ice skating); Monti Ryan (songs and dances); Max Kirby (songs and dances). Sydney Jerome at the piano.

WEDNESDAY, SEPTEMBER 11th.
11.0-11.45 p.m.

Lydia Sokolova (Prima ballerina of the late Diaghileff Russian ballet); Cyril Smith (pianoforte solos); Daisy Kennedy (the well-known violinist); Olive Groves (soprano); Morgan Davies (baritone).

another staunch supporter of pioneer television, will also appear. With her will be Daisy Kennedy, the well-known violinist, Morgan Davies, the Welsh baritone, and Cyril Smith, the celebrated young pianist.

Even those listeners without 30-line receivers will tune in London National just before

for the Week

HIGHLIGHTS OF THE WEEK

FRIDAY, SEPTEMBER 6th.
 Nat., 8, Beethoven Promenade Concert. 10, B.B.C. Orchestra.
 Reg., 8, "The Mystery of the Seven Cafés." 8.50, R.A.C. Tourist Trophy Motor Race. 9.10, B.B.C. Military Band.
Abroad.
 Hilversum, 8.10, Wagner Symphony Concert.

SATURDAY, SEPTEMBER 7th.
 Nat., "Guess Who it Is"—anonymous variety show. ¶"The American Negro," by Alastair Cooke. ¶Promenade Concert. Reg., Promenade Concert. ¶Elsie Carlisle and Sam Browne.
Abroad.
 Radio Paris. 8.45, Songs from Opera and Operetta.

SUNDAY, SEPTEMBER 8th.
 Nat., Sheffield Transport Dept. Band. ¶Recital of English spirituals. Bournemouth Municipal Orchestra, conducted by Richard Austin.
 Reg., London Zigeuner Orchestra. ¶Adolph Hallis and the Phil-Melodic Quintet. ¶London Symphony Orchestra.
Abroad.
 Leipzig. 8, Classical Symphony Concert.

MONDAY, SEPTEMBER 9th.
 Nat., B.B.C. Dance Band. 8, Wagner Promenade Concert. ¶Pianoforte Recital by Isabel Gray. ¶B.B.C. Orchestra, conducted by Frank Bridge.
 Reg., 8, "The Air-do-Wells." ¶Talk: "America and Us," by Harold Nicolson. ¶B.B.C. Theatre Orchestra.
Abroad.
 Frankfurt 9, "Our Beethoven."

TUESDAY, SEPTEMBER 10th.
 Nat., B.B.C. Theatre Orchestra. 8.40, "The Air-do-Wells." ¶B.B.C. Orchestra, Section C.
 Reg., 8 "Band Room No. 5." 8.30, International Concert, relayed from Budapest.
Abroad.
 Kalundborg. 7.30, Danish Musical Festival in the "Tivoli" Concert Hall, Copenhagen.

WEDNESDAY, SEPTEMBER 11th.
 Nat., Fred Hartley and his Novelty Quintet. 8.30, "Friday the Thirteenth," radio play. ¶Transatlantic Bulletin.
 Reg., Bach Promenade Concert. 9.40, Variety Hour.
Abroad.
 Frankfurt, Stuttgart. 10.30, Light music from Cologne.

THURSDAY, SEPTEMBER 12th.
 Nat., B.B.C. Dance Band. ¶Promenade Concert. 10, Midweek Service. ¶B.B.C. Theatre Orchestra.
 Reg., 8.15, "Mystery of the Seven Cafés." ¶Concert by the B.B.C. Singers and Orchestra.
Abroad.
 Berlin (Deutschlandsender) 8.50, Berlin Philharmonic Orchestra.

11.45 on Wednesday to hear the last of the high pitched whine which has proved almost as irritating as the more extreme examples of modern music.

BELA BARTOK IN INTERNATIONAL CONCERT

LOTS are cast to determine in which order the countries of Europe shall contribute to the new series of broadcasts arranged by the International Broadcasting Union. Hungary was the first name drawn from the hat and so, on Tuesday next, half Europe will be listening to a special Liszt concert from the Royal Hungarian Opera House in Budapest.

Bela Bartok, the ultra-modern composer, will be solo pianist in the Totentanz (Dance of Death), and the orchestra will be conducted by Ernest Dohnanyi. The Symphonic Poem "Tasso" is included in the programme, which will be relayed to British listeners on the Regional wavelengths at 8.30.

PRIEST IN COMIC OPERA

OPERETTA seems rather scarce this week, but on Saturday Leipzig gives us Millocker's "Feldprediger" (Army Chaplain) at 8.10 p.m. with an attractive cast supported by the Symphony Orchestra and Choir. Clergymen are not stock characters in operetta, but this particular gentleman is apparently guaranteed not to cause even one yawn.

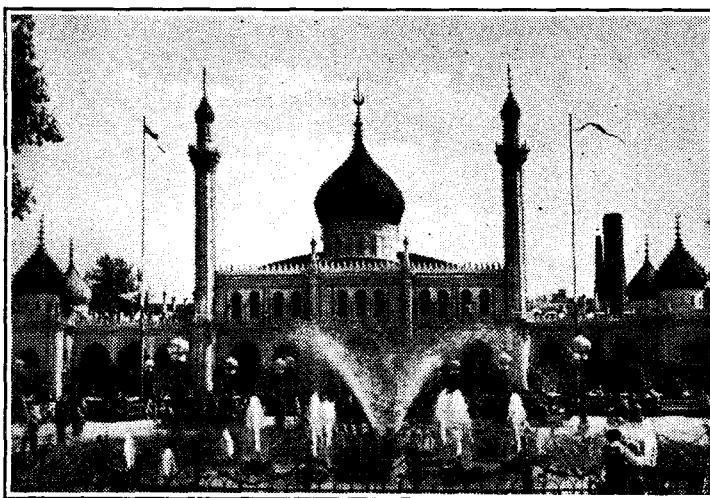

TIVOLI, COPENHAGEN, from which Denmark's annual Music Festival will be relayed by Kalundborg between 7.30 and 11.40 on Tuesday evening.



Running commentaries on the international gliding match on the Jungfrauoch (Switzerland), 10,000ft. above sea level, are being given by Swiss and Austrian stations between 9.45 and 10.15 p.m. on Tuesday next.

AMERICA'S BEST

KALUNDEORG has a new feature: relays of the world's dance bands. The first of the series is at 11 p.m. to-morrow (Saturday), when some of America's best jazz teams will be overheard via the short-wave stations of the N.B.C.

FOR OPERA LOVERS

FOR the Wagner lover, Vienna offers the real treat to-night (Friday) of a gala performance of "The Valkyrie," relayed from the Royal Opera House at 6.25.

French comic opera at its best is represented to-night by Adolphe Adam's charming two-act opera, "Le Toreador," which Beromunster is giving at 9.10. Another attraction this evening is Marschner's romantic opera "Hans Heiling," from Stuttgart at 12.

Shakespeare's works have always been a powerful magnet to Italian composers, notably Verdi, whose "Falstaff" was recently relayed from Salzburg. "The Taming of the Shrew" has been transformed into a four-act opera by Persico, and will be broadcast to-morrow night (Saturday) from Rome.

BOXING CHAMPIONSHIP

RUNNING commentaries and news bulletins from the Continent are apt to be tedious to those who are not linguists, but there are several "newsy" events this week which many British listeners should be able to follow in whole or in part. To-night (Friday) from 11 to 11.40 Konigsberg relays a recorded commentary, with accompanying sounds, of the sailing on her maiden voyage from Hamburg of the new motor ship "Tannenberg."

An eye-witness account of the World's Flyweight Championship at Bellevue, Manchester, comes from Poste Parisien at 10.30 p.m. on Monday.

DANISH MUSIC FESTIVAL

THE annual Danish music festival in the "Tivoli" music hall, Copenhagen, takes place on Tuesday next, from 7.30 to 11.40. The concert, which affords an excellent opportunity to form an opinion of Danish musical standards today, will be relayed by Kalundborg. One word of warning: the relay includes half an hour of the international concert at Budapest, so do not begin recalibrating your receiver! THE AUDITOR.

New Apparatus Reviewed

Recent Products of the Manufacturers

B.R.C. SHORT-WAVE CONVERTER

THIS short-wave converter covers the unusually wide wave-range of 13.5 to 200 metres. This band is covered in three steps, their respective coverages being 13.5 to 40, 30 to 90 and 80 to 200 metres approximately. The coils are built-in and the ranges selected by means of a switch which changes aerial and oscillator coils simultaneously.

A Triode-Hexode frequency changer is used. The aerial and oscillator circuits are tuned by a gang-condenser, and a small trimming condenser is joined in parallel with the aerial section to compensate for different aerials. Both condensers are fitted with slow-motion drives, the main one having a two-ratio pattern giving the option of a 12 to 1 or a 150 to 1 reduction.

The unit is entirely self-contained and can be operated from either AC or DC supplies, as universal mains valves are employed. The wave-change switch serves also to change over the aerial from the converter to the receiver for normal broadcast reception.

Tests were made with the converter connected to superheterodyne sets as well as to straight receivers, and while the performance was in every case satisfactory, the best results were, of course, obtained with the most sensitive of the sets tried, for it must be remembered that the converter does not in itself give much amplification, its function being to receive and act as a frequency changer only. The IF used in this case is 1,800 metres.

Several American short-wave stations were heard on range one—below 40 metres—also amateurs on 20 metres came in on this band. The lower part of range two—30 to 90 metres—gave DJA and DJN, both very strong signals, also GSB and many unidentified stations, several of which were of quite good programme value. Range three did not add much to the list of telephony stations, but it was very full of CW signals. Some amateurs on 160 metres or so came in very well indeed.

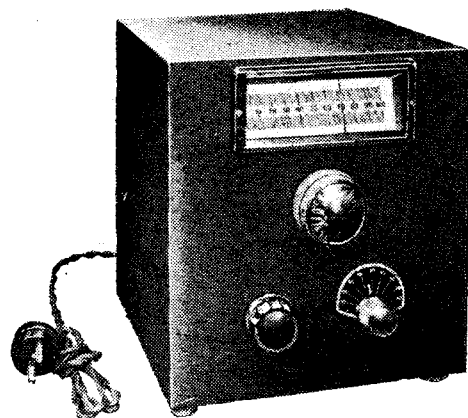

B.R.C. short-wave converter fitted with universal mains valves and a self-contained power pack.

On the whole the B.R.C. converter is a most satisfactory unit; it is simple to install and to operate, and has the distinct advantage of being entirely self-contained, for it

includes its own power supply unit. The makers are the British Radiovision Corporation, 56, Hazel Road, London, N.W.10, and the price is £8 8s.

B.T.S. TRIPLE-RANGE SW COIL

BRITISH TELEVISION SUPPLIES, LTD., Bush House, London, W.C.2, include in their new season's short-wave components a triple-range coil which can be obtained either as a single unit with switch or as a dual assembly and with ganged wave-change switches.

The coil has a nominal coverage of 12 to 80 metres when tuned by a 0.0002 mfd. condenser. In addition to the grid coil there is a reaction winding and also a third coil which can be employed either as the aerial

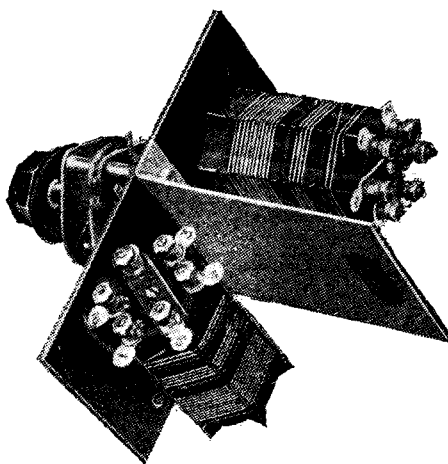

B.T.S. triple-range dual short-wave coil unit.

coupling or as the primary should one of the coils be used as an HF transformer.

The primary winding is quite loosely coupled, as the coil has not been designed to give a high HF stage gain, but the dual assembly is intended mainly to provide an easily assembled HF stage with tuned input and intervalve couplings. Incidentally, the two-coil assembly could be used in a superheterodyne circuit.

The dual unit was tested in an HF-det-LF circuit using a two-gang 0.00016 mfd. condenser, and with this we obtained a waveband coverage of 10 to 65 metres, there being an adequate overlap between each of the three ranges. The small inter-coil screen fitted provides adequate shielding, for, as already mentioned, a high stage gain is not attempted. No trouble was experienced from break-through of stations on any other waveband.

The unit is simple to install, as it is mounted on the panel by a single-hole fixing bush which serves also as the bearing for the spindle of the wavechange switch. It is a neat and quite efficient coil unit, and the price is 17s. 6d.; the single-coil model costs 12s. 6d.

PEAK HIGH-VOLTAGE CONDENSERS

W. ANDREW BRYCE & CO., Woodfield Works, Bury, Lancs, has recently introduced a new series of high-voltage fixed

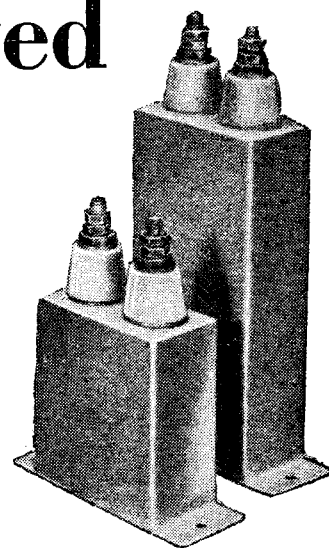

New Bryce high-voltage condensers; the smaller model is a 0.1 mfd. 1,000-volt type and the larger a one-mfd. for 2,000 volts working.

condensers, several models of which will be found suited to the needs of television, especially in cathode-ray tube exciter units and in time base circuits.

The new condensers are made in capacities of from 0.1 mfd. to 10 mfd. and for working voltages of 1,000, 1,500 and 2,000 DC. They are housed in metal cases designed to occupy the minimum baseboard space consistent with reasonable dimensions in other directions. The terminals are mounted on the top and insulated from the case by porcelain pillars. A one-mfd. size, for example, in the 2,000-volt class measures 6½ in. high and has base dimensions of 3¼ in. × 1¼ in. only. All condensers are tested at three times the rated working potential, so a good margin of safety is allowed.

A 0.1 mfd. size costs 3s. 6d. in the 1,000-volt working class, 4s. in the 1,500-volt type, and 4s. 6d. for the 2,000-volt model; while a 2-mfd. in each class costs 7s. 6d., 10s. and 12s. 6d. respectively.

THE RADIO INDUSTRY

LODGE sparking plugs of a special screened type, designed to reduce interference with radio reception by the ignition system, are now available in a form suitable for use in ordinary cars. These plugs have been produced as a result of experiments carried out during a number of years with screened plugs for military aircraft.

An interesting booklet sent to us by Mellows and Company, of Corporation Street, Sheffield, describes the Mellozing process of zinc spraying. This method of applying a conductive metal coating to a number of surfaces (including wood) is now finding important applications in the anti-interference field, as well as for general screening of radio apparatus.

Under the self-explanatory title of "High Fidelity Sound and Radio Equipment," R. A. Rothermel, Limited, of Canterbury Road, London, N.W.6, have issued a useful booklet dealing with piezo-electric appliances. This book is intended for distribution among technicians and manufacturers of radio and public-address equipment.

The new season's catalogue of Clix plugs, sockets, valve holders and various forms of connectors, is now available from Lectrolinx, Limited, 79a, Rochester Row, London, S.W.1.

Motional Impedance

Its Effect on Loud Speaker Performance

By F. R. W. STRAFFORD

THE speech coil of a loud speaker is relatively free to move in an intense magnetic field. Consequently, its impedance does not bear the same relation to frequency as does that of a normal fixed coil. An apparent increase takes place; this is known as motional impedance, which accounts in practice for the well-known bass resonance of practically all speakers.

PRACTICALLY every amateur, and certainly all technicians, are aware of the definition and properties of electrical impedance, and are able to apply this knowledge to practical cases.

When dealing with electro-acoustical apparatus (e.g., a loud speaker) the term "motional impedance" is very often used and, to many, must leave some doubt as to its nature and general effect.

If one examines, for instance, the impedance characteristics of the speech coil of a moving coil loud speaker when carrying currents at various frequencies, the resultant effects are not generally concomitant with normal electrical circuits comprising inductance and resistance.

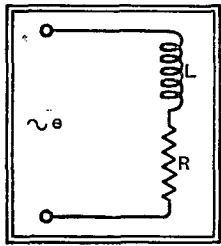

Fig. 1.—Equivalent electrical circuit of a clamped speech coil.

An analysis of the problem may be best commenced by considering what is, in essence, the mechanism of this type of loud speaker which contains a magnetic flux, of which the direction lies along the radial axis of the coil.

The passage of an electric current through the coil results in the production of a magnetic flux which reacts upon the steady flux in the gap and produces a force. If the conductor is free to move, the force is expended in the form of motion along its winding axis, the direction of motion being determined by the polarity of the current. An alternating current will therefore give rise to an equivalent motion of the conductor coil, and by suitably coupling it to a membrane or diaphragm sound pressures are created and radiated into the surrounding air.

If one were to rigidly clamp a speech coil so that the presence of current through it was unable to produce any motion, it could be represented by the simple circuit of Fig. 1, which barely requires any explanation.

It must, however, be borne in mind that neither the resistance nor inductance is completely fixed in value. The presence of the iron or steel surrounding the magnetic gap is sufficient to cause small varia-

tions of the speech coil inductance at different frequencies and also at different current intensities. Likewise, the resistance of the speech coil is affected somewhat by the variation, at different frequencies, of the hysteresis losses in the magnet material close to the gap. Nevertheless, these are secondary effects and may be neglected from our studies of motional impedance.

Speech Coil Impedance

Although the majority of speech coils consist of fewer than one hundred turns of wire, it must not be thought that the rate of change of electrical impedance with frequency is likely to be any less than that obtained with a coil of many turns with the same volume of copper, or of whatever substance the conductor may be comprised. It may be shown, mathematically, that, to a first approximation, the rate of change of impedance with frequency is proportional only to the volume of the winding, and is therefore independent of the number of turns upon the coil, providing equal volumes are maintained.

The main reason for the present-day use of speech coils with few turns and heavy wire is to facilitate construction and assembly, and is therefore of practical import only.

Fig. 2 shows a typical frequency impedance characteristic of a clamped speech coil of which the DC resistance is 1.91 ohms at 20 deg. Centigrade. The inductance measured at 1,000 cycles is 194 microhenrys. The frequency characteristic shown by curve A has been calculated from the simple formulæ $Z = \sqrt{R^2 + (WL)^2}$, using the values of R and L given above.

Curve B was obtained by actual measurement, and shows that the values of R and L are obviously not quite constant, due to the causes already described.

If the coil is now unclamped the forces acting upon it, whenever a current is made to flow, are translated into motion. Newton's famous law of the reaction forces on a system may now be applied and are worthy of some note here. The sum of the reaction forces on a system must equal the applied force, and may, in the case of the moving-coil speaker, be grouped into three components. First, the reaction force due to the mass of the system may be discussed. This mass comprises all moving parts such as the speech coil, its former, the diaphragm, and a certain calculable mass of air.

The reaction force of this concentrated mass is proportional to its acceleration. The second component is devised from the frictional properties of the system, and is proportional to velocity, while the third and final component of reaction force is due to elasticity, and is proportional to displacement.

It is rather beyond the scope of this article to set out the general Newtonian equation of forces as represented by the combined effects of the three components which have been classified, but it is sufficient to say that this equation is very similar to that which represents the total voltages operating across an electrical network comprising inductance, resistance, and capacity in series. In fact, the similarity is so great that mechanical systems may be replaced by equivalent electrical

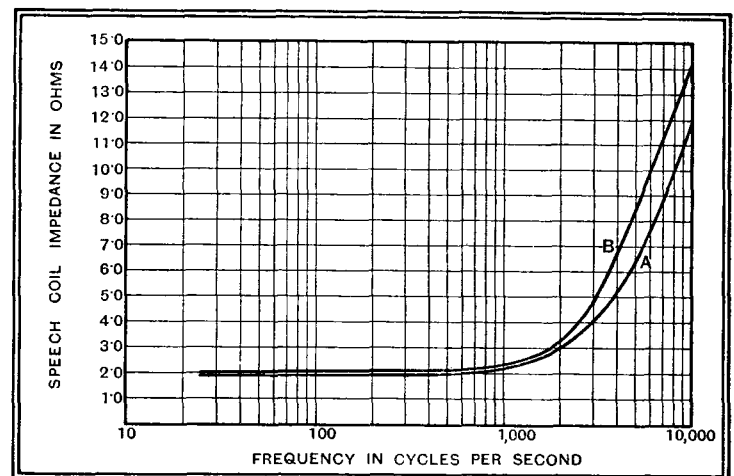

Fig. 2.—Frequency/impedance characteristic of a typical speech coil when firmly clamped. Curve A, calculated; curve B, measured.

circuits in which mass is replaced by inductance, frictional effects by resistance, and elasticity by the reciprocal of capacity. By such a method one may predict the behaviour of vibrating mechanical systems by simply solving their equivalent electrical networks. One would therefore expect conditions for natural resonance to occur in mechanical circuits under certain

Motional Impedance—

conditions, an expectation which is fully justified in practice. The dimensions of mass elasticity and frictional damping of the average moving-coil loud speaker are such as to provide a natural resonant frequency lying within the approximate region of 20 to 150 cycles per sec. It is this resonance which gives the effect of enhanced low-note response, and if judiciously used may be of real assistance in maintaining a useful response over the low-frequency range.

When an electrical circuit is supplied with an alternating potential equal in frequency to the natural frequency of the circuit, the current which flows is dependent purely upon the resistance of the circuit and rises to its maximum value.

In a like manner, an alternating force applied to a mechanical system whose natural frequency is equal to the frequency of the applied force, will produce a velocity which is dependent only upon the frictional losses of the system.

Now the velocity of motion of the speech coil, when driven at the resonant condition, is quite high. This fact may be made clear by stating that the speech coil velocity is proportional to its displacement for a given frequency, and it does not require much observation to notice the excessive excursions made by a speech coil when driven or impulsed at its resonant frequency.

It is here that the principles of motional impedance may be introduced and discussed.

Although an electromotive force is neces-

sary to create the reaction fluxes whereby the speech coil motion is produced, it must also be remembered that the motion of a conductor in a magnetic field will create an electromotive force. Unfortunately, the applied and created EMFs are in phase opposition, otherwise perpetual motion might be quite easily achieved!

This newly created electromotive force is proportional in magnitude to the velocity of the vibrating speech coil, and reaches a sharp maximum, therefore, at the resonant condition of the loud-speaker driving system. The net EMF acting at this particular frequency is thereby reduced, although still sufficient to cause

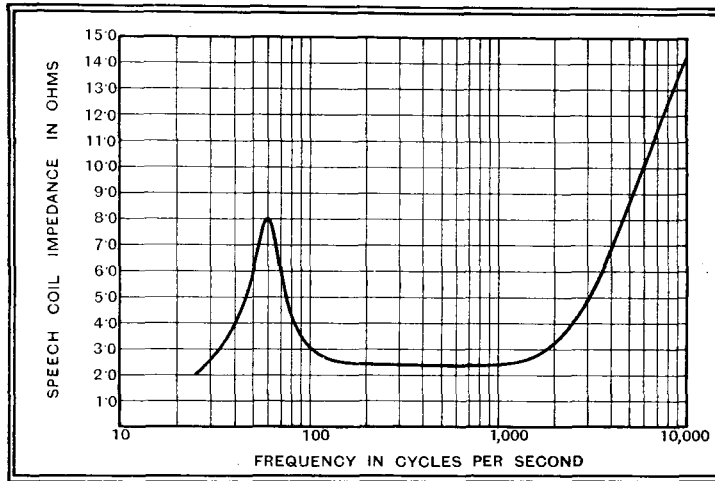

Fig. 3.—Showing the effect of motional impedance; the frequency characteristic of the same speech coil to which Fig. 2 relates when it is free to move.

a powerful vibration. This reduction in the net EMF acting across the coil is equivalent to stating that the impedance of the coil has risen with respect to the original applied potential, so far as the current through the coil is concerned; and since it is the current which produces the ultimate driving force, it is better to assume that the impedance of the coil has been modified from its original clamped value. This apparent increase in impedance constitutes the motional impedance, and its magnitude is determined by the mechanics of the moving system, the length of the conductor comprising the coil, and the strength of the magnetic field in which it is immersed.

Impedance at Resonance

The curve in Fig. 3 may now be examined; here the impedance/frequency characteristic has been replotted after unclamping the coil. The added motional impedance in the neighbourhood of resonance is very evident, and has increased the normal impedance by more than three times.

It is clear that such an increase will cause quite serious mismatching of load referred to the output valve when such a speaker is coupled to it. In the case of pentode output stages, serious distortion can arise from this source, and it is essential to place some form of buffer resistance across the primary or secondary of the output transformer to flatten out the effect. The valve

must be judiciously chosen, as a certain amount of useful power is obviously wasted. On the other hand, its inclusion is sufficiently justified when using loud speakers with relatively low frictional damping and correspondingly marked resonance at their natural frequency.

Enlarging Television Images

THE cathode-ray tube, when used as a television receiver, is handicapped from one point of view by the fact that the fluorescent screen must be housed inside the glass bulb. This, combined with the low light intensity of the fluorescent effect, places a definite limit on the size of the received picture. Many attempts have been made to overcome this difficulty, though so far with but little success.

One suggestion is to utilise the electronic stream, not as a source of fluorescence inside the bulb, but as a generator of X-rays (after the well-known manner of Dr. Rontgen). The X-rays are then focused through a sort of pin-hole camera on to a viewing screen, which is arranged outside the glass bulb, where there is no restriction on its size.

As shown in the figure, the cathode ray first passes through the usual control and scanning electrodes and is then made to impinge upon an anti-cathode A, where it produces bundles of X-rays. The rays readily pass through the glass walls of the tube, where they are intercepted by an opaque shutter S of lead,

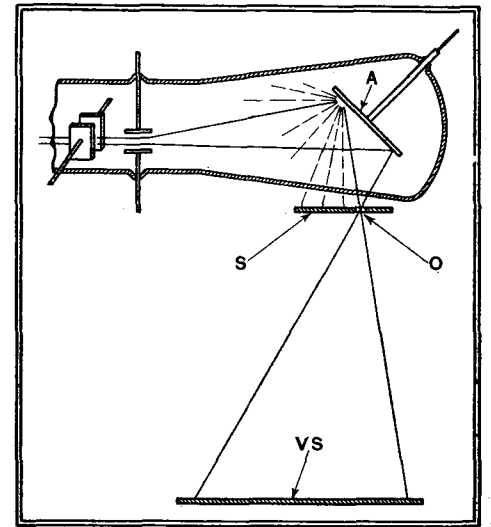

Combining the principles of the cathode-ray and X-ray tube.

pierced with a central aperture O. This serves as a pin-hole camera so that an image of each point of the anti-cathode A is focused on to a fluorescent viewing screen VS.

Since the fluorescent effect of X-rays is known to be much more intense than that of the ordinary cathode-ray stream, some, at least, of the loss due to the use of the pin-hole camera is made good in this way.

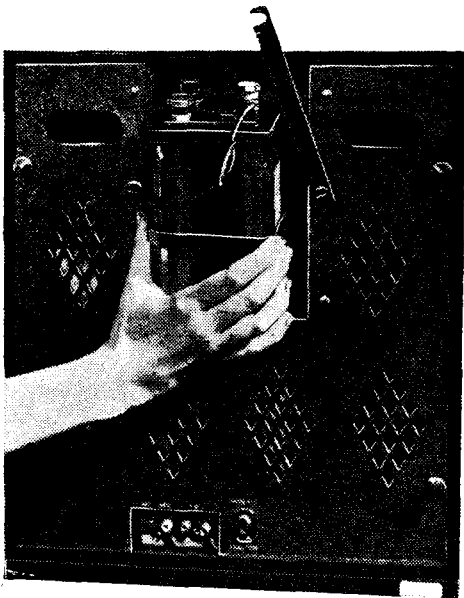

Easy accumulator replacement: a trap-door fitted in the back of the H.M.V. battery superhet.

BROADCAST BREVITIES

A Spare Wavelength

LIKE the gentry who "left their country for their country's good," 30-line television, by its cessation after Wednesday next, may leave us all in its debt if only because it will release a valuable wavelength on Monday and Wednesday nights, which can be used for an alternative to dance music.

Many listeners would relish light music of the kind provided by the Gershom Parkington Quintet during that sleepy hour before "tumbling in." At present they must either seek their soothing music abroad or school themselves to accept negro syncopation as the proper prelude to dreamless slumber.

Will the Programme Department seize this new opportunity to please thousands of listeners who like to end their day with good music?

Mr. Robb's Future

IT would be a pity if British television were to lose the services of Mr. Eustace Robb, whose future work with the B.B.C. is still wrapt in mystery. No one else in this country has had the same experience in producing entertainment for the television screen.

Over three years ago Mr. Robb shouldered the task of producing television programmes with no established standards to work upon and with that slenderest of entertainment mediums—the 30-line screen. That he made a success of it from the start none will dispute.

Too Ambitious?

If a fault could be found in the programmes it is that they have been almost too ambitious, but this is a fault on the right side.

Ballet, pantomime, art exhibitions, opera, revue, animal performances, marionette shows, a boxing match, a ju-jitsu display—all these and many other items have figured in the displays, and the pity is that so few people, comparatively speaking, have witnessed them.

Let us hope that Eustace Robb will be given a good share in the programme arrangements at the Alexandra Palace.

"Proms" Commentaries

THE success of the commentaries by Eric Maschwitz on the Radiolympia variety shows has prompted people to ask why something of the same sort could not be done in the case of the Promenade Concerts in the Queen's Hall.

If one misses the preliminary announcement, and is without

By Our Special Correspondent

the B.B.C.'s official programme paper, it is very difficult to follow the course of the concerts.

Silence Cabinet

Few listeners would ask for an actual running commentary. ("Sir Henry Wood is bowing and smiling . . . Madame Effulgent Exquisita is now walking on attired in one of the new phantom skirts, feminine but not floppy . . . the horn player has taken the spout off his instrument and is shaking it . . . double bass gnaws bottom string, etc.") What would be welcomed would be brief announcements between items which could either be given from the studio or from a silence cabinet in the gallery.

Winter Promenade Concerts

Perhaps such an innovation might be introduced at the

grim stoicism which characterises all information departments.

But even the steely faces of the B.B.C. men twitched the other day when this fluttered in:—

"I have been suffering from extremely painful inflammation of the knuckle joints and finger joints of my right hand. This had all the appearance of an attack of gout, and as none of the usual remedies did any good I have wondered if the swelling can be traced to excessive use of the short-wave band. My radio is an Italian Superla, and I use the short waves for Empire programmes, etc. I seem to have read of what is called hand capacity from use of short-wave sets. I hope you will be able to tell me a cure and how to prevent future attacks.

"Yours, etc., _____"

Unfortunately, I am not permitted to publish the official



A BREATHLESS MOMENT. A Norwegian "O.B." engineer in a tight corner. The story is told on this page.

winter season of "Proms," which is to be given from Monday, December 30th, 1935, to Saturday, January 11th, 1936. This, by the way, will be the third winter season to be given by the B.B.C. Symphony Orchestra under the direction of Sir Henry Wood.

Hand Capacity

SCORES of letters are received daily by the B.B.C.'s Technical Correspondence Department, and most of them are answered automatically with that

reply, which was highly confidential.

Perils of "O.B." Work

OUTSIDE broadcasting is not usually reckoned as among the dangerous trades, but M. Hougen, of the Norwegian Broadcasting Company, has his own opinion on the question.

The other day Mr. Hougen narrowly escaped serious injury. In company with a squad of recording engineers he proceeded north from Oslo to compile a programme dealing with peasant

life in the wilder parts of the country. One of the items was to be a commentary, with sounds, on the branding of some 2,500 head of reindeer, and to get it the party went up into the mountains at Setedalsheine, 4,000 feet above sea level, taking a portable short-wave transmitter mounted on a sledge.

Concealed Microphone

The microphone was concealed between two stones in the middle of a plateau with the idea of getting an impressive "sound shot" of the stampede after the branding had been carried out. For some reason the microphone leads appeared suddenly to go "dead," so Mr. Hougen crept out to investigate, intending to say a few words into the mike to test it. But he had forgotten that his assistants, acting on instructions, were at that identical moment starting the stampede. As the terrified animals came tearing across the open space towards him, Mr. Hougen had only time to fling himself down between boulders.

Accidental Photograph

So as not to lose his nerve he proceeded to give a running commentary on what was happening, and it was at this moment that the nearest engineer, in his excitement, accidentally snapped the shutter of his camera, producing the picture which appears on this page.

Thrills at Shelsley Walsh

LISTENERS are being specially catered for this year by the Midland Automobile Club, organisers of the Shelsley Walsh International Open Hill-climb, which will be the subject of a broadcast on September 28. A new arrangement has been made whereby all the fastest cars and crack drivers will be grouped together during the period of the broadcast, and this, it is hoped, will prevent listeners from missing, as they have sometimes done owing to breakdowns on the hill, some of the star climbs of the meeting.

The running commentators will again be Mr. F. J. Findon and Major Vernon Brook.

Brooklands Broadcast

BROOKLANDS racing track has never yet figured in the broadcast programmes but, if present plans materialise, we may hear a description of the mountain race on the famous course at 3.30 p.m. on October 19th.

This race is an open international event with varying gradients and colossal speeds.

Readers' Problems

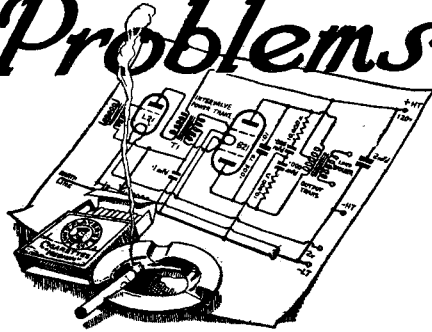

THESE columns are reserved for the publication of matter of general interest arising out of problems submitted by our readers. Readers requiring an individual reply to their technical questions by post are referred to "The Wireless World" Information Bureau, of which brief particulars, with the fee charged, are to be found at the foot of this page.

Economy in the L.F. Amplifier

AS a general rule, it is safe enough to say that there is not much to choose between the various "straight" systems of LF amplification from the point of view of economy in anode current. At any rate, this is true if the matter is considered on the basis of "gain per milliamp."

A resistance-coupled stage, as ordinarily arranged, admittedly consumes less current than one with transformer coupling, but it gives so much less magnification that an extra stage may be needed.

This is in answer to a reader who is planning a rather ambitious battery set in which economy of HT current is an important consideration.

Erratic Push-pull Behaviour

A READER has noticed that if one of the valves on his push-pull output stage is removed the set goes on working almost normally, but on replacing this valve and taking out the other, "motor-boating" is produced. It is asked whether this is an indication that one of the valves is defective.

We do not think so. The effect of removing either valve is to increase the amount of LF feed-back to the earlier stage of the amplifier; in one case the effect thus produced will be "degenerative" or anti-reaction, while in the other it will be pro-reaction, and thus will cause oscillation or "motor-boating" as noticed by our reader.

Why the Rheostat?

REFERRING to the Compact Battery Two, described in last week's issue, a reader enquires whether it would not be possible to simplify the operation of the set by replacing the adjustable filament rheostat by a fixed resistor of the correct value for absorbing the surplus voltage of the 3-volt dry LT battery specified.

The reason why such a course would be impracticable is not far to seek. The whole story is really told by the curves of Fig. 1,

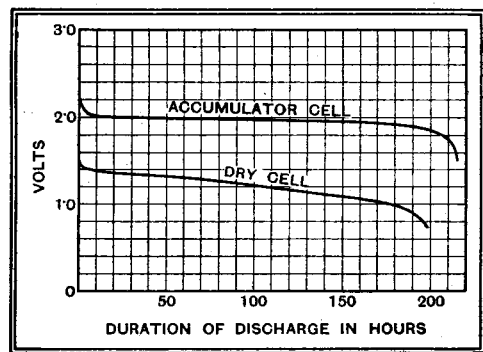

Fig. 1.—The voltage of a dry LT battery when worked intermittently is even less constant than this curve would suggest; means of compensation are therefore necessary.

which show that the voltage of a dry cell is by no means as constant as that of an accumulator. When dry cells are used for LT purposes it is consequently necessary to have some means of compensating for this rapid decline of voltage. In addition, it is a great advantage to have (as in the receiver under discussion) a measuring instrument as an aid to making the right adjustment.

The 1936 Monodial

IT should be made clear that the tuning condenser used in the latest Monodial receiver is not of the standard superheterodyne type; all three sections are alike, and an oscillator section with specially shaped plates is not employed.

Long-wave Shortcomings

A USER of a fairly straightforward superhet complains that performance has fallen off on the long waves, although it is as good as ever on the medium band. Little, if any, improvement has been brought about by re-ganging the set although the manufacturers' service instructions have been carefully followed when carrying out the operation. Our correspondent has had little experience of fault-tracing, and asks us to suggest a likely place for the defect.

By a process of elimination we may rule out the IF amplifier and everything succeeding it as being common to both medium and long-wave bands. The fault must lie in either the signal-frequency or oscillator circuits, but the tuning condenser is presumably in order. Continuing the process of elimination, we are left with the long-wave sections of the signal-frequency or the oscillator coils, the wave-change switches, or the long-wave padding condenser. Of all these, the last mentioned seems, from our querist's description of the symptoms, to be the most probable source of the trouble.

Working Hours

WE are asked to say how the number of hours "life" per charge of an LT accumulator may be estimated.

In theory this is simple enough; all one has to do is to divide the ampere-hour capacity of the cell by the current consumed by the receiver (expressed in amperes or fraction of an ampere). Thus a 20-ampere-hour cell should supply current to a receiver taking 0.5 amp. for 40 hours. In practice one cannot always depend entirely on this calculation, as the capacity of the cell may be rated on a different discharge rate. However, the method suggested will give a very good idea as to the output that may be expected.

Harmful Resistances

ALTHOUGH precise information regarding all the new season's sets is not yet available, it seems fairly certain that the extension loud-speaker terminals are, in a great majority of cases, wired across the secondary of the output transformer. Indeed, this practice was fairly well established last year.

When the terminals are wired in this manner it is, of course, necessary to use an extension speaker without a built-in transformer, and that the moving coil of the external instrument should have approximately the same resistance as that included in the set itself.

Although the connections of the external speaker are so simple when matters are arranged in this way, there is one small point which, to judge by several letters recently received, does not always get sufficient attention. This relates to the resistance of the leads used for connecting the external speaker; as the resistance of the coil itself may be very low—possibly one or

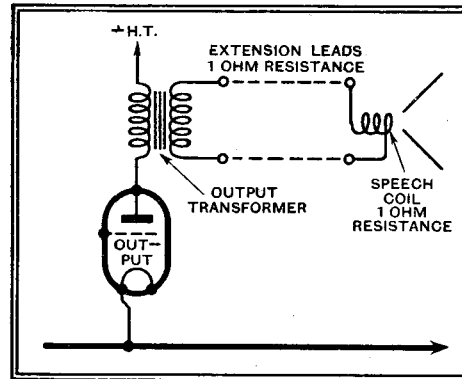

Fig. 2.—The resistance of speaker extension leads connected in this manner may be comparable with that of the speech coil, with consequent loss of volume.

two ohms—it follows that, to avoid loss of volume and frequency distortion, it is necessary for the resistance of the wires to be low in relation to that of the coil.

This probably explains why several readers who are using extension loud speakers have recently complained of poor quality and reduced volume. Their trouble may be almost certainly overcome by shortening the extension leads as much as possible and also by using wire of a reasonably heavy gauge.

The Wireless World

INFORMATION BUREAU

THE service is intended primarily for readers meeting with difficulties in connection with receivers described in *The Wireless World*, or those of commercial design which from time to time are reviewed in the pages of *The Wireless World*. Every endeavour will be made to deal with queries on all wireless matters, provided that they are of such a nature that they can be dealt with satisfactorily in a letter.

Communications should be by letter to *The Wireless World* Information Bureau, Dorset House, Stamford Street, London, S.E.1, and must be accompanied by a remittance of 5s. to cover the cost of the service.

Personal interviews are not given by the technical staff, nor can technical enquiries be dealt with by telephone.

The Wireless World

THE PRACTICAL RADIO JOURNAL
25th Year of Publication

No. 837.

FRIDAY, SEPTEMBER 13TH, 1935.

VOL. XXXVII.

No. 11.

Proprietors : ILIFFE & SONS LTD.

Editor :
HUGH S. POCOCK.

Editorial,
Advertising and Publishing Offices :
DORSET HOUSE, STAMFORD STREET,
LONDON, S.E.1.

Telephone : Hop 3333 (50 lines).
Telegrams : "Ethaworld, Sedist, London."

COVENTRY : Hertford Street.
Telegrams : "Autocar, Coventry." Telephone : 5210 Coventry.

BIRMINGHAM :
Guildhall Buildings, Navigation Street, 2.
Telegrams : "Autopress, Birmingham." Telephone : 2971 Midland (4 lines).

MANCHESTER : 260, Deansgate, 3.
Telegrams : "Iliffe, Manchester." Telephone : Blackfriars 4412 (4 lines).

GLASGOW : 26B, Renfield Street, C.2.
Telegrams : "Iliffe, Glasgow." Telephone : Central 4857.

PUBLISHED WEEKLY. ENTERED AS SECOND CLASS MATTER AT NEW YORK, N.Y.

Subscription Rates :
Home, £1 1s. 8d. ; Canada, £1 1s. 8d. ; other countries, £1 3s. 10d. per annum.

As many of the circuits and apparatus described in these pages are covered by patents, readers are advised, before making use of them, to satisfy themselves that they would not be infringing patents.

CONTENTS

	Page
Editorial Comment	291
Three-in-One Portable	292
Loud Speaker Baffles	296
Hints and Tips	300
Current Topics	301
Superheterodyne Whistles	302
500 Kilowatts from Finland?	305
Through German Eyes	306
Listeners' Guide for the Week	308
Andrea Set Review	310
Random Radiations	311
Broadcast Brevities	313
Unbiased	314
New Apparatus	315
Letters to the Editor	316

EDITORIAL COMMENT

"Not for Broadcast"

Conflicting Interests Which Must be Harmonised

FROM the very first days of the establishment of a broadcasting service in this country no satisfactory solution has been found for avoiding the friction which has existed between the press and the B.B.C. on the question of the dissemination of news.

Objection was naturally raised by the press to the idea that a new organisation, possessing a complete monopoly of a new means of distributing news, should be permitted to compete unfettered, because it was felt that newspapers would be very seriously affected by such an invasion of their own particular sphere of activities. In the early days a compromise was reached, the news agencies undertaking to supply the B.B.C. with a daily news summary which would not conflict with the newspaper interests. This was the alternative to allowing the B.B.C. to collect its own news and act independently of the press. This arrangement was entered into with the authority of the Postmaster-General, whose representative presided over the meetings at which the arrangement was formulated.

From small beginnings the B.B.C. has grown to a great organisation, and it is not unnatural that those responsible for it are no longer timid in their attitude towards other bodies, where formerly they were most anxious to avoid offence. But, if the principle that the B.B.C. ought not to compete with the press in the distribution of news was right when originally formulated, it is surely much more so to-day when the organisation has grown so much in power and influence and when its competition would be

infinitely more serious than it would have been at the outset.

On very many occasions we have expressed the view that it is very regrettable that the activities of the B.B.C., where they conflict with other interests, have not been defined. No attempt has ever been made by the Government to settle the frontiers, as they may be described, of the B.B.C., with the result that all parties whose interests border on those of the corporation view every fresh move with distrust.

There have been several cases recently where broadcasts have forestalled the press in the distribution of news, and this has aroused fresh friction culminating in the recent distribution of news agency items marked "Not for Broadcast." Until the bounds of the B.B.C. have been established there can be no proper co-operation between broadcasting and the press or any other organisation where broadcast activities tend to encroach.

Defining B.B.C. Activities

It is quite proper that under present circumstances the B.B.C. should hold its present frontiers and endeavour to extend them wherever possible. We do not wish to see a B.B.C. fettered in its service to the public, but we believe that, in its own interests as well as those of the public and of the organisations with which it has come in conflict from time to time, it is imperative that the position should be cleared up. Until this is done there will always be friction, and real co-operation, such as we believe ought to be achieved, is impossible. Much public money, time and ingenuity is wasted by the B.B.C. in the task of watching its frontiers when the same effort could be far more usefully employed in the general improvement of the service.

THE Three-in-One Portable

By "LUCIFER"

IN a recent issue of our contemporary "World Radio" there appeared an interesting article describing the uses of an unconventional portable receiver. We are now able to publish a technical description of the set, with full constructional details. Bulk and weight have been reduced to well below the usual limits, and the true portability of the set is enhanced by the highly practical shape of the container

IT is fairly obvious that the compromise which has to be made in the design of a portable receiver is between performance and portability; the greater the portability desired the greater will be the sacrifice in performance. Individual tastes will undoubtedly differ as to the relative importance which should be attached to these two attributes, but the main objective is to make the performance-to-weight ratio as high as possible. The performance which it was hoped to achieve in the present receiver was such as to provide for reception of alternative programmes in all but outlying parts of the British Isles, which implies sensitivity sufficient to produce a readable headphone signal from field-strengths of the order of 2 mv/m in the medium-wave band and 10 mv/m in the long-wave band.

If conventional portable sets are analysed it soon becomes apparent that the

loud speaker is responsible, directly or indirectly, for a large proportion of the weight. The loud speaker itself often weighs several pounds, whilst its operation also imposes the need for a considerable degree of amplification and the use of a fairly large high-tension battery to provide the necessary power for the output stage. All this can be dispensed with if it is decided to provide for headphone reception only.

It is not claimed that the set to be described is by any means the smallest which could be made, but simply that it represents one compromise out of the many possible. The receiver itself, excluding the headphones and battery space, occupies only about 3 $\frac{3}{4}$ in. deep by about 6 in. square. A smaller receiver could probably be achieved by the use of some form of super-regenerative circuit which would work on a very low anode voltage, but the arrangement adopted has the merit of being straightforward and reasonably accessible.

A start was made, then, by assuming a frame aerial, headphones, 2-volt unspillable accumulator and high-tension battery. The batteries now account for a large proportion of the weight, and accordingly they were considered first. It was decided to try a 60-volt high-tension battery of low capacity, so battery catalogues were searched for such a battery having dimensions appropriate to one or other of the various types of small unspillable accumulator available.

There were two or three possible combinations, and finally Drydex, type H1003 and Exide PY3 batteries were selected.

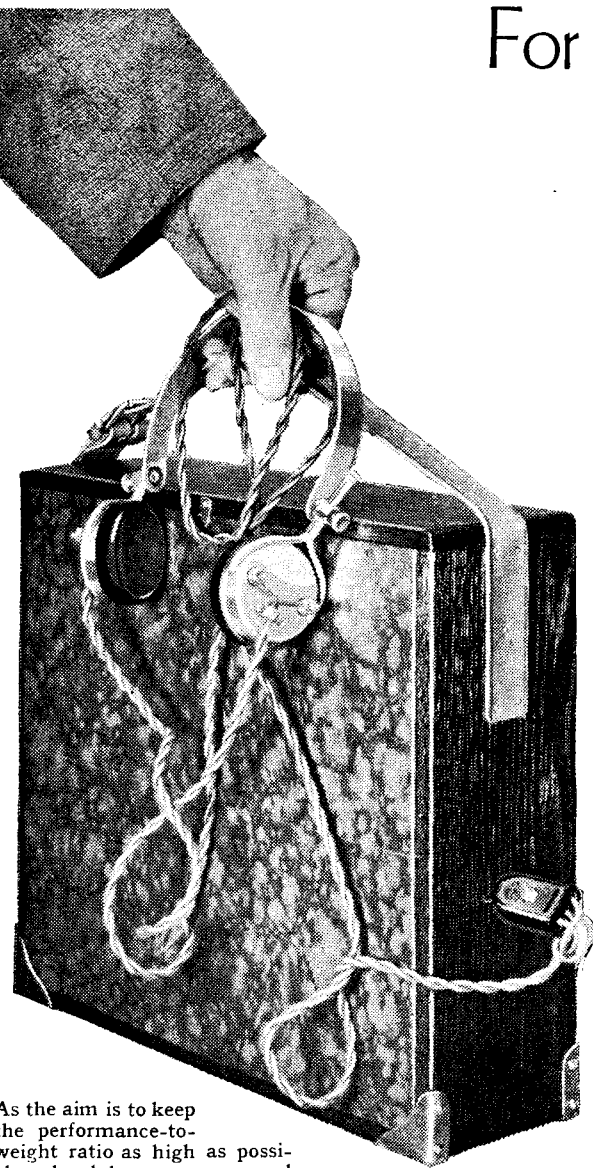

As the aim is to keep the performance-to-weight ratio as high as possible, headphones are used instead of a speaker.

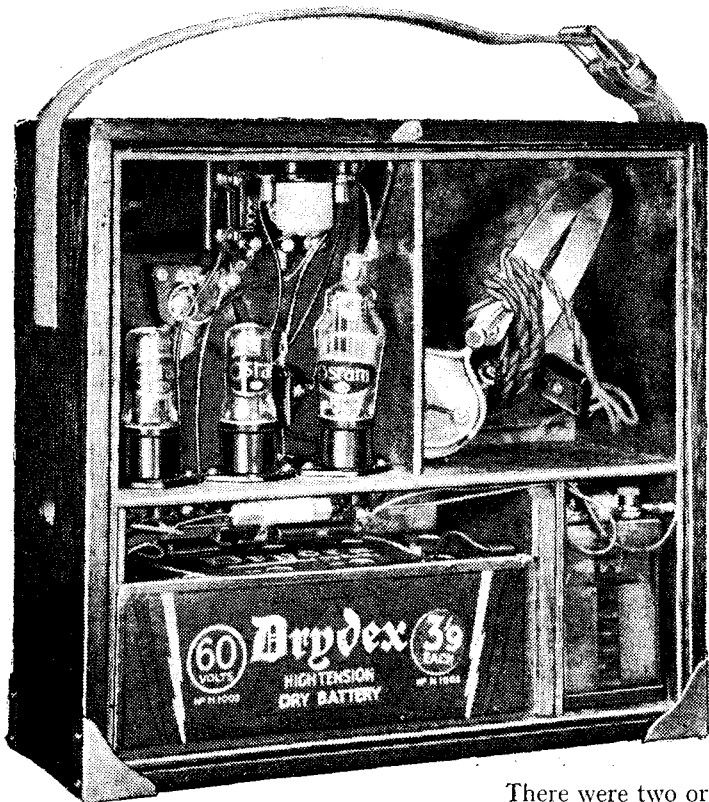

The back cover is easily removable to give access to the components.

Now the batteries chosen would be expected to provide economically the current for three modern valves. If a straight circuit were adopted it would have to be either 2 HF and detector (2-V-0), detector and 2 LF (0-V-2), or HF-detector-LF (1-V-1). By comparison with the third arrangement, which was finally chosen, the first was found to be difficult to stabilise without reducing the overall gain to a value considerably below that provided by the 1-V-1 arrangement. It had, moreover, the disadvantage of distortion on loud signals such as were produced in London by the local transmitters. The second arrangement was also tried, but, as expected, was considerably less sensitive, and was further ruled out on account of its much greater drain on the high-tension battery. The 1-V-1 receiver, when made up, was found to have approximately the desired performance, so that further consideration and experiments were unnecessary.

No mention has so far been made of the type of valves used. In the first experiments valves of normal dimensions were tried, as it was hoped that improved performance would result from the use of an HF pentode as against a screened-grid

Travelling, Out of Doors, or as a "Stand-by" Set at Home

valve, and the former type was unobtainable in a small envelope. The HF pentode, however, proved intractable when worked with 60V. on the anode, it being very difficult to stabilise on long waves without reducing the screen potential to a value which at the same time considerably reduced its sensitivity. With a normal screened-grid valve, satisfactory operation could be obtained on both wave-bands with the screen connected direct to 60V.+, that is at a slightly higher potential than the anode. The valves finally selected were the Osram midget type, VS24/K, HL2/K and HL2/K. Actually, sufficient space has been allowed to permit the use of valves of normal dimensions if desired. If this is done, valves having comparable characteristics should be chosen. Conversely, if it is decided to use the midget valves specified the height of the framework can be slightly reduced.

Aperiodic HF Stage

In selecting a tuning condenser, the choice rested between the air-dielectric and solid-dielectric types. In view of the greater compactness of the latter it was decided to sacrifice the gain which theoretically results from the use of an air-spaced condenser. Choke coupling for the first stage, as against a second tuned circuit, was decided on for two reasons—first, it is difficult to gang a frame aerial with a screened coil; and secondly, either a 2-gang condenser or two separately tuned condensers would have been necessary, increasing considerably the bulk of the receiver portion. Actually, the selectivity without an additional tuned circuit is adequate, except when working within a few miles of a high-power twin-wave transmitter. In such an area, however, the frame can be turned to the minimum position to reduce signals, and the selectivity increased by judicious use of the reaction control.

The reaction circuit is better taken from the detector anode than from the screened-grid anode. The introduction of the reaction circuit at the screened-grid anode reduces the impedance into which this valve works, and thus, also, the gain of the stage, whilst the HF component appearing in the detector anode circuit needs in any case to be eliminated, and by using a differential condenser part of

it can easily be passed back, *via* a reaction winding, to the frame. With a reaction winding of four turns tightly coupled to the medium-wave frame, reaction effects were satisfactory on the medium-wave band, but oscillation occurred rather early on long waves. The latter was quite con-

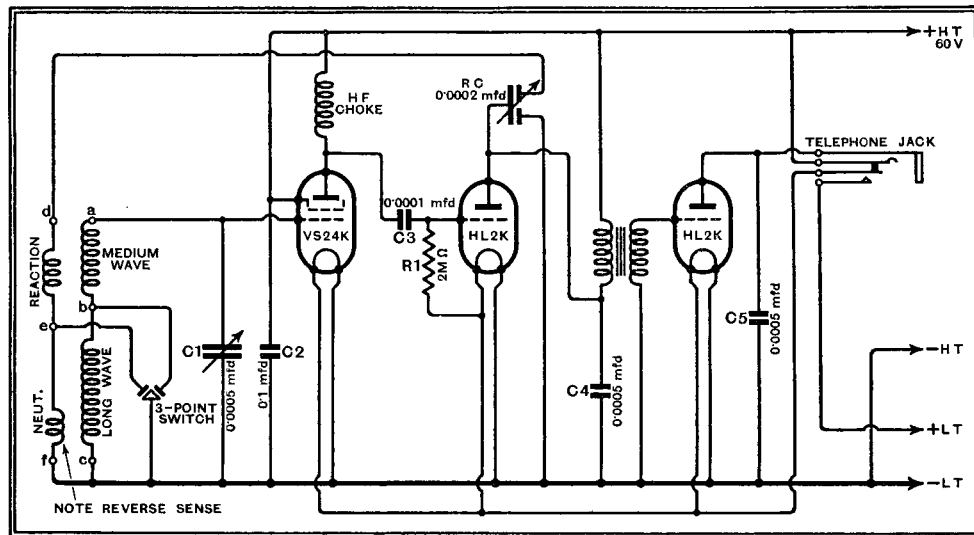

Fig. 1.—Complete circuit diagram. Reference lettering to frame-aerial windings corresponds with that in Figs. 2 and 3.

trollable, but the operation on long waves has been improved by the addition of a two-turn neutralising winding which is wound in the opposite sense to the medium-wave winding, and only functions on the long-wave range. The reaction conditions are, of course, somewhat unusual, but choke coupling, using an ordinary HF choke, is more efficient on long waves than on medium and, therefore, the set needs far less applied reaction to produce instability on its long-wave range. The screened HF choke selected is of very small dimensions.

The detector and LF portions of the circuit follow conventional lines, except as noted in the next paragraph. Cumulative grid detection is employed and the primary of the midget LF transformer is connected directly in the detector anode circuit. The current flowing in this circuit is about 0.5 milliamp., which is insufficient to have any serious DC magnetising effect on the core of this transformer.

It will be noted that no negative bias is applied to the grid of the LF valve, but this is not so reprehensible as it may appear. With less than 60 volts on the anode, the bias required would be well under 1 volt. A single cell is, therefore, too much, and to reduce this would introduce the complication of a potentiometer and by-pass condenser. A bias resistor could be inserted in the common negative lead and by-passed with a condenser, and this was indeed tried, but it introduced other complications without doing any apparent good. The set works quite happily without bias, and there is no audible evidence of its omission. The easy course of taking the grid return lead to LT negative has, therefore, been adopted.

Connection of the headphones to the receiver is effected by a plug and jack, the jack being provided with an additional

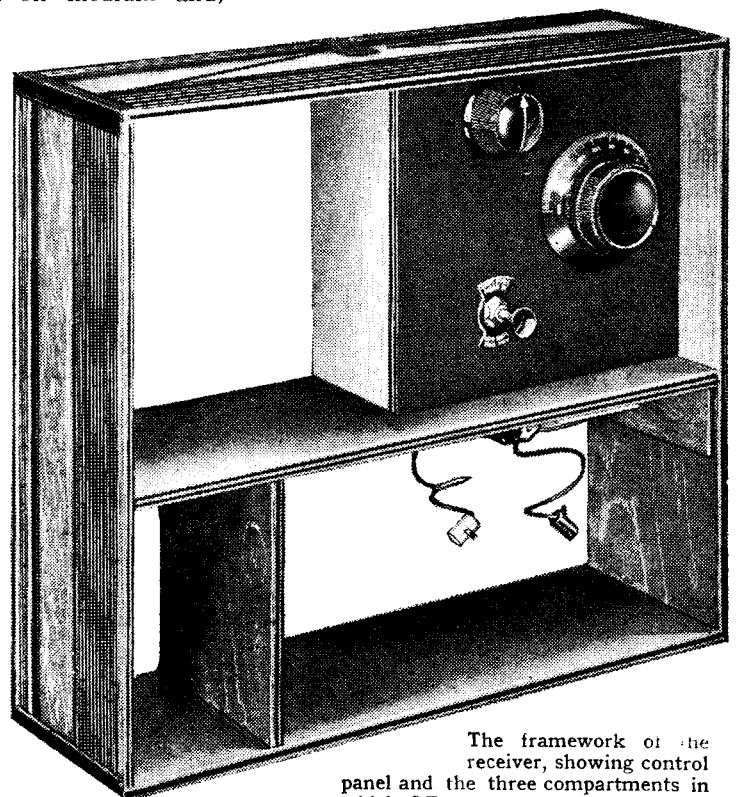

The framework of the receiver, showing control panel and the three compartments in which LT battery, HT battery, and phones are accommodated.

The Three-in-One Portable—

pair of contacts which are connected in the LT + circuit, and thus the insertion and withdrawal of the headphone plug switches the receiver on and off—an auto-

section of the frame, with the high-frequency choke in position, and to complete the wiring by making the necessary connections to the choke. The screening cover of the choke is connected to the low-potential side of the circuit via the GB terminal of the LF transformer, while the high-tension connection to the choke is made from the HT terminal of the transformer. When the wiring is completed and the remainder of the framework assembled, the set should be complete except for the

frame aerial and reaction windings. If desired, the wiring can be checked by fitting the batteries and phones and testing at the usual points with a meter.

In order to prevent possible cutting of the wires of the frame aerial and reaction winding by the corners of the wood, and to give a good grip to the wire, the corners should each be covered by a strip of insulation tape. The aerials are so disposed that the medium-wave winding is at the back of the receiver, so as to avoid hand-capacity effects when the receiver is being tuned.

The medium-wave winding is wound with Litz wire, starting at the grid terminal of the HF valve, taken under the shelf, through the end section, and then wound in a clockwise direction (looking at the back of the set), finishing by taking the wire through the top section of the

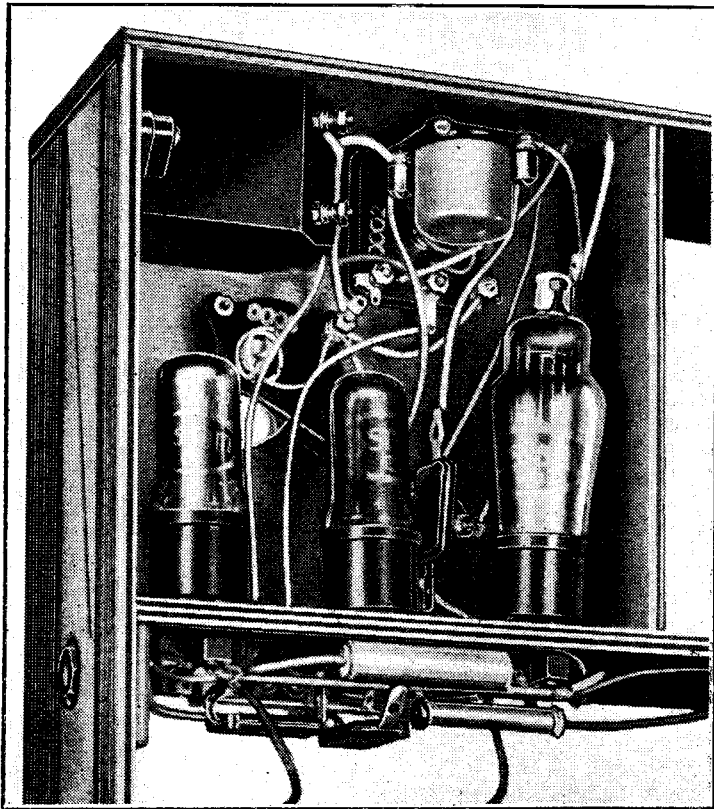

A "close-up" of the receiver unit.

matic precaution against leaving the receiver on when not in use. The battery consumptions are: LT, 0.35 amp.; HT, 4 milliamps.

Owing to the very limited space available in the receiver compartment, the construction of the set will be considerably simplified by mounting the main components before assembling the wooden framework. The dimensions and method of construction of the framework should be quite clear from Figs. 2 and 3. The whole of the framework is constructed of four-millimetre ply wood which, for appearances' sake, should preferably be oak-faced and stained and polished.

Constructional Details

The simplest method of assembly is to mount the components on the shelf, the panel and the end piece of the framework, according to the dimensions given in Fig. 2. These three members can then be joined together and, at this stage, a good deal of the wiring can conveniently be done. Care should be taken before assembly, however, to drill small holes in the shelf through which wires will subsequently have to pass. It should also be noted that the telephone jack is first mounted upon a small strip of wood, and then fitted so that its fixing nut projects through the clearance hole in the end of the main framework and is approximately flush with the surface of the latter.

The next step should be to fix the top

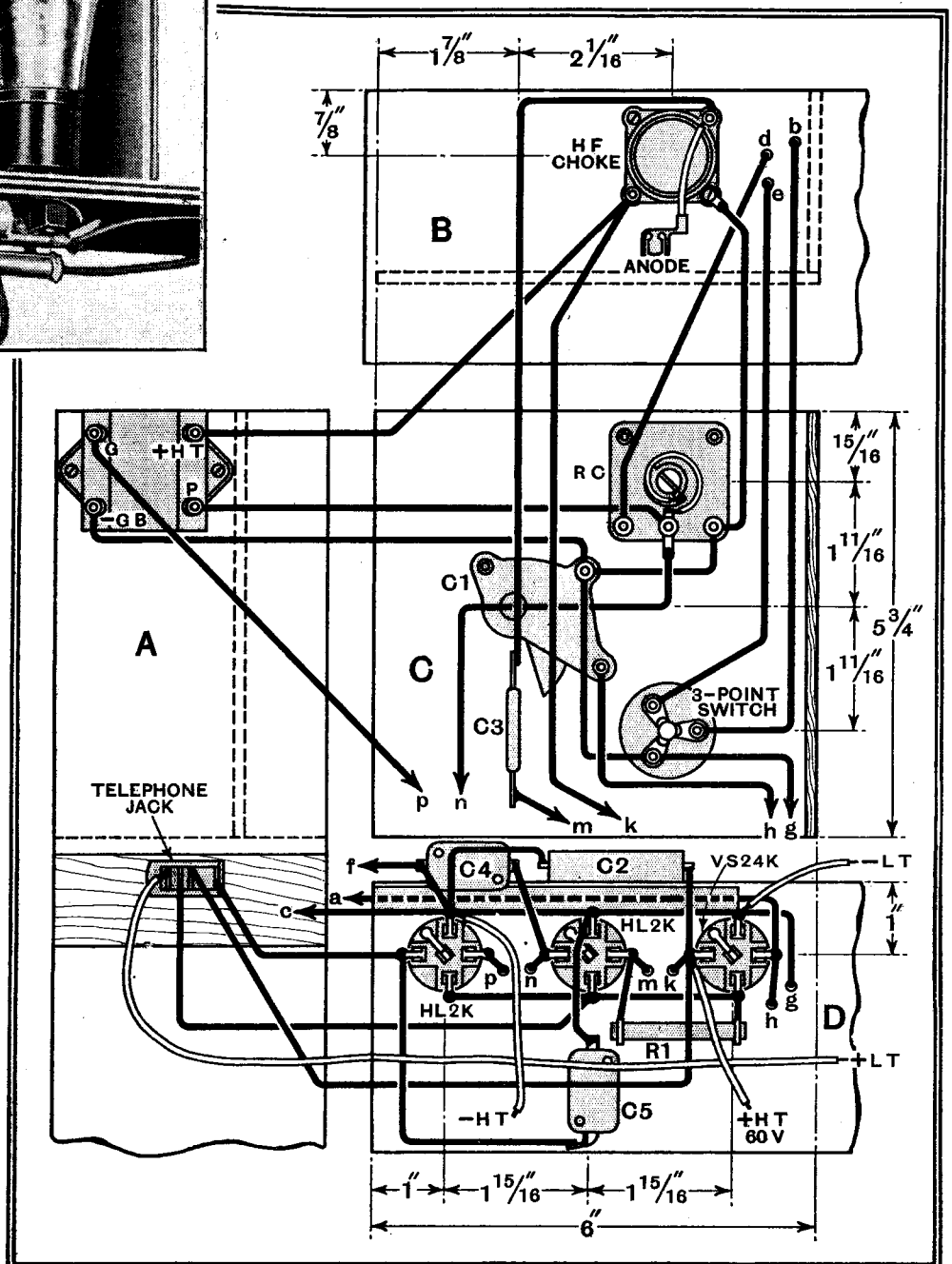

Fig. 2.—Practical wiring plan, with dimensions for locating components. Reference letters a-f indicate connections to the frame aerial windings; from g onwards they identify leads passing through the valve platform. Side of framework, top of framework, back of front panel and underside of valve platform are indicated by A, B, C, and D respectively.

The Three-in-One Portable—

frame and connecting it to one of the terminals of the wave-change switch. The number of turns is fourteen, and the first turn should be $\frac{3}{16}$ in. from the back edge of the framework. The connection between point *a* on the frame (shown in dotted lines in Fig. 2) and the HF grid is protected and secured in position by a strip of adhesive insulating tape.

Next wind on four turns for the reaction winding, using 26-gauge DSC wire, beginning at the free terminal of the reaction condenser and ending on the second free terminal of the wave-change switch, winding in a clockwise direction, and spacing the first turn of the winding $\frac{3}{16}$ in. from the end of the medium-wave aerial winding

The Neutralising Winding

Continuing from the end of the reaction winding on the wave-change switch, wind on the long-wave neutralising winding. This consists of two turns of the same wire, wound in the opposite direction—that is, anti-clockwise. This winding is finished by taking the wire through a small hole in the end of the framework and connecting it to LT negative. The neutralising winding is placed $\frac{1}{16}$ in. from the reaction winding.

The final winding is the long-wave section of the frame aerial. This consists of fifty turns wound in a clockwise direction, beginning on the wave-change switch terminal at which the medium-wave frame winding ends, the end being taken through the framework and connected to LT-. The spacing between the neutralising winding and the long-wave winding should be $\frac{3}{16}$ in., which should allow the latter to finish about $\frac{1}{16}$ in. from the front edge of the wooden frame.

It will now be seen that with the wave-change switch in the medium-wave position, both the long-wave section of the frame aerial and the neutralising winding are short-circuited, while in the long-wave condition the two frame aerial windings are in series, as also are the reaction winding and the neutralising winding.

The outer framework of the case is the only part of the receiver which calls for any real skill in woodworking. This may be constructed of $\frac{3}{4}$ in. teak or oak. Other woods could doubtless be made to serve

LIST OF PARTS

- 1 Variable condenser, 0.0005 mfd. Log Law C1 Ormond R/503
- 1 Dial for above Ormond R/352
- 1 Differential condenser, 0.0002 mfd., and knob RC Ormond R/510
- 1 Fixed condenser, 0.0001 mfd., C3 T.C.C. "M"
- 2 Fixed condensers, 0.0005 mfd., C4, C5 T.C.C. "M"
- 1 Fixed condenser, 0.1 mfd., C2 T.C.C. 250
- 1 HF Choke Wearite HFPJ
- 1 LF Transformer, 1:5 Varley "Nictet"
- 3 Valve holders, 4-pin Bulgin VH7
- 1 Three-point switch Bulgin S36
- 1 Grid Leak, 2 megohms, R1 Erie E30
- 1 Telephone Plug B.T.S.
- 1 Three-Spring Automatic Jack B.T.S.
- 1 Valve Connector Belling-Lee 1175
- 2 Wander Plugs and 2 Spade Ends Eefex
- 1 LT Accumulator, 2 volts, 11 ampere hours Exide PY3
- 1 HT Battery, 60 volts Drydex H1003
- 1 Pair Headphones N.R.S. "Jubilee" Lightweight
- 20 yards Litz Wire, 9/40 DSC (Golstone) and 2 ozs. No. 26 DSC Wire for frame aeri-als.
- Wood, Screws, Systoflex, small quantity No. 22 tinned copper wire, etc.
- Valves: 2 HL2/K, 1 VS24/K Osram

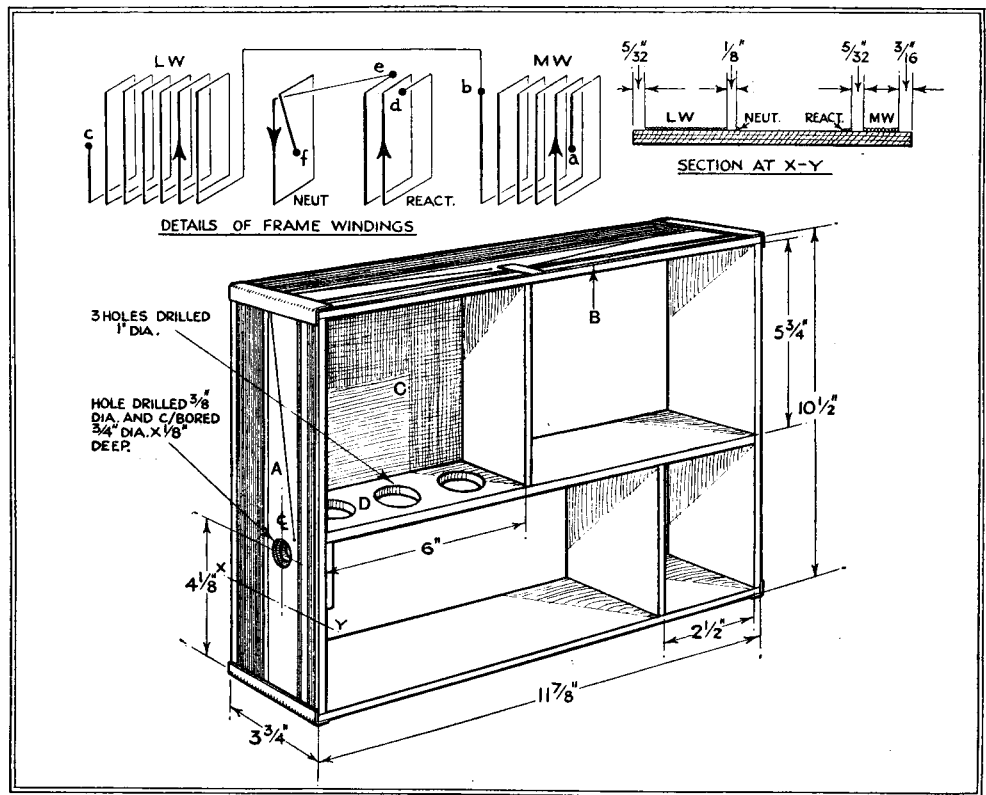

Fig. 3.—Construction of the framework and winding details of frame, neutralising, and reaction windings. Reference lettering corresponds with Figs. 1 and 2.

equally satisfactorily, but teak, in particular, has the advantage of taking on a very pleasing and durable finish when rubbed well with linseed oil, without any other form of polish. The corners of this outer framework should be dovetailed, and, unless the constructor is skilled in such work, he will probably be well advised to have this frame made by a professional quite a simple job, and will usually be made up at a cost of a few shillings. The back and front of the case are made from ordinary $\frac{3}{16}$ in. plywood covered with leather cloth. It is advisable to make the "hinge" for the front by joining the pieces with a strip of calico before covering with leather cloth. The bottom half of the front is fixed permanently by gluing it in position.

The uses to which the set has recently been put were described fairly fully in an article which appeared in the issue of *World Radio* dated August 16th, 1935. Its performance in regard to home transmitters has been referred to above. Though not designed for reception of distant stations, the sensitivity is such that most of the more powerful of these can be received after nightfall. On its first test at a position only eight miles from Brookmans Park, thirty-eight stations on the medium and long wavebands were received without interference from the two local transmissions. This was achieved by carefully turning the set to the position of minimum reception from Brookmans Park.

It should be emphasised that a set of this description does depend very largely on the directional properties of the frame aerial for selectivity. When use is made of this, however, the set will be found to have ample selectivity to receive any

reasonably strong signals without interference from transmissions on neighbouring wavelength channels. The frame aerial has a very sharp "minimum" point, and this can also be used to great advantage where electrical interference exists, such as, for instance, from generators when using the set in a compartment of a train. In the same way, the set is an extremely useful tool for tracing sources of electrical interference.



AT A JUTLAND FAIR. A "snap" showing a public address speaker, reputed to have a 2-mile voice, fitted to a captive balloon by a Danish electrical firm.

Loud Speaker Baffles

Types in Current Use and Their Influence on the Sound Output

By N. W. McLACHLAN, D.Sc.

TO gain a clear insight into the part played by baffles in the radiation of sound from a loud speaker, it is necessary to consider first the simplest case of the plane baffle.

In Fig. 1, D represents a flat diaphragm vibrating along the axis X1 X2. When it moves to the right the air at that side of the diaphragm is compressed slightly, that at the other side being reduced in pressure by an equal amount. Since the air on the two sides of the diaphragm is at different pressures, there is an acoustical short-circuiting effect unless the two sides are screened from each other. The purpose of a baffle is to act as an acoustical screen.

A baffle may take various forms, the

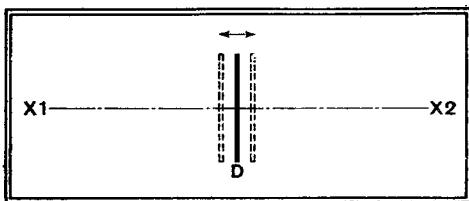

Fig. 1.—Illustrating action of a diaphragm without a baffle.

simplest of which is a large flat board with a hole at the centre to accommodate the diaphragm, as illustrated in Fig. 2. At any instant the sound pressure at Z is due equally to that from both sides of the diaphragm. Since one is positive and the other negative (in a relative sense), the net pressure at Z is zero. Thus in free air if one listened in the plane of the baffle, there would be no sound—i.e., under ideal conditions. Consider the sound at the point Z1 in front of the diaphragm. This point is nearer to the front than it is to the back of the diaphragm. Since the sound waves have farther to travel in the one case than in the other they do not cancel

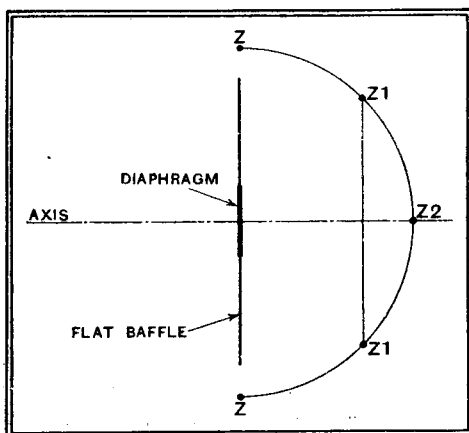

Fig. 2.—With a flat baffle, the sound pressure at Z2 is a maximum and at Z, zero.

THE baffle is an important, indeed an essential part of any loud speaker and a clear understanding of the fundamental principles underlying its action is necessary if it is to be properly applied.

out, so we should hear a sound at Z1. When the point is on the axis, as shown at Z2, it is farther from the rear of the diaphragm than Z1 or any other intermediate point equidistant from the centre. Hence the sound pressure at Z2 exceeds that at Z1.

Sound Pressure Curves

If a diagram is drawn showing the sound pressure at various positions, the shape of the curve depends upon the frequency. To calculate the curve, each side of the diaphragm is represented by a very small sphere pulsating in free air so that there are no reflections from walls. The spheres are separated by a distance equal to that round the baffle from centre to centre, i.e., the diameter of a circular baffle. One sphere expands whilst the other contracts, and vice versa, so that on a line at right angles to that which joins them the two sound waves cancel out, as they do in the plane of a baffle. Two pairs of polar curves for a baffle 3 feet in diameter at frequencies of 120 ~ and 370 ~ are shown in Fig. 3 (a). These curves refer to points in space six or more diameters away from the centre of the diaphragm. In the first case the curves are almost circular, whereas at a higher frequency there is no sound on the axis and the power is concentrated at angles of about 60 deg. on either side. This directional effect is due to waves from the back interfering with those from the front of the baffle. With an infinite baffle, e.g., in practice an extremely large wall, the curves would be semi-circles, as shown in Fig. 3 (b). The fact that they are not semi-circles means that there is a loss of sound power due to

interference. For a baffle of given size the power loss depends upon the frequency. The power is maintained at a certain value down to the cut-off frequency below which it decreases. The steady value is equal to that from one side of the diaphragm in an infinite baffle.

It may be useful to have some approximate numerical data relating to the cut-off point of a baffle, so Fig. 4 is given with this in view. The low-frequency power begins to decrease when the wavelength of the sound exceeds about twice the length of the side of a square baffle. This result is deduced from the ideal case of the two pulsating spheres mentioned above, where the diaphragm is very small, in fact what the mathematician is pleased to call a point source. Consequently, with diaphragms from six to twelve inches diameter the cut-off frequency is somewhat higher, owing to the distance round the baffle from edge to edge of the diaphragm being less than from centre to centre. In fact, the curve will not give the cut-off with any degree of accuracy unless the diameter of the diaphragm is small compared with the length of the side of the baffle. It may be of interest to state that with a

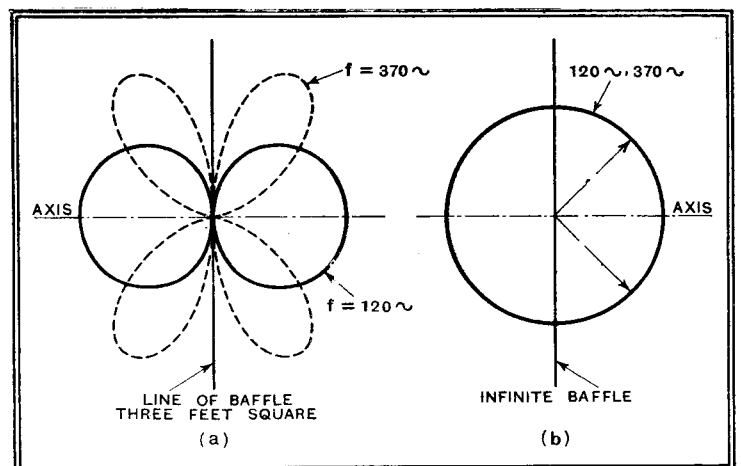

Fig. 3.—(a) Sound distribution at each side of flat baffle 3ft. square at 120 ~ and 370 ~. (b) Sound distribution at each side of infinite baffle at 120 ~ and 370 ~.

diaphragm 8in. in diameter the effect of an infinite baffle is to raise the power level 18 decibels at 50 ~ compared with that due to the unbaffled diaphragm. Readers are doubtless well aware that the infinite baffle condition can be obtained by putting the speaker in a hole in the wall. Those who adopt this procedure are

Loud Speaker Baffles—

usually proud of the results obtained. The bass is increased if the hole is near one of the corners of the floor or ceiling.

Another case of interest is the reduction in power with a given baffle as the fre-

quency is decreased. This is shown in Fig. 5 for a baffle three feet square with a small diaphragm at its centre, and the cut-off frequency is in the neighbourhood of 200 ~. If, therefore, a speaker is tested using a baffle three feet square, and it is

not realised completely, but the sound output is a minimum as illustrated in Fig. 6 for a baffle four feet square. For a baffle three feet square the dip would occur between 700 and 800 ~. Despite the dip, however, there would not be any appreciable variation in sound power, since it is concentrated at angles to the axis as shown in Fig. 3. It follows, therefore, that one must interpret axial pressure curves with caution.

Above a certain frequency, which depends upon the diameter of the cone, the sound is projected in the form of a beam, and removal of the baffle has but little influence on the sound power. The ratio of the power

with and without the baffle can be calculated for a diaphragm and a sphere of equal diameter vibrating along its axis. The result is:—

Power from infinitely baffled diaphragm
 Power from unbaffled sphere
 $\frac{3}{2}$ approx. at higher frequencies
 where the sound is focused, say, above 1,500 ~.

In what precedes we have treated the question of flat baffles in free-air where the sound can pass away into space. Practical conditions are different, and auxiliary effects are introduced. The conditions are usually complex enough to defy calculation, but there are certain basic facts which can be corroborated by experiment. Owing to reverberation, room resonance and standing waves, the characteristic curve of a loud speaker

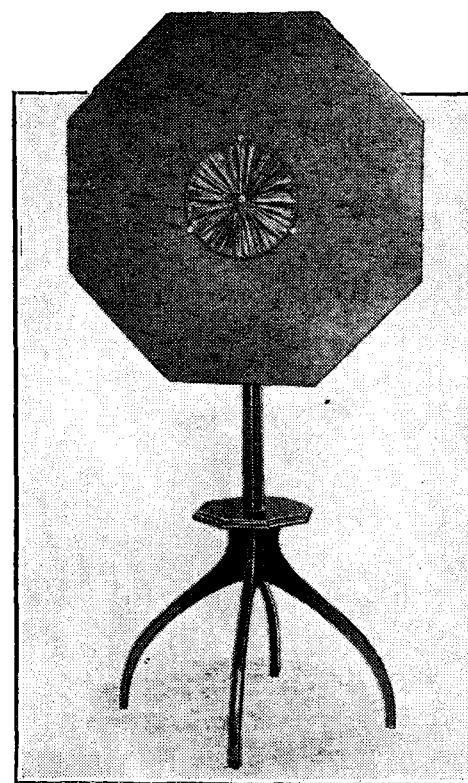

A baffle for a special loud speaker described in the "Wireless World" in 1930.

The hills and hollows at the low frequencies are due to pronounced room effects. Under this condition it pays to reduce the bass register by using a smaller baffle or introducing some form of correction in the amplifier. Increasing the magnetic field of the magnet sufficiently also serves the same purpose, and gives a harder and more pleasing bass response.

Some Practical Considerations

We come now to the question of baffles other than the flat type. Broadly speaking, anything which shields one side of the diaphragm from the other can be termed a baffle. For household purposes it seems inevitable that one should try to make a loud speaker as inconspicuous as possible. This attitude is hardly justifiable, since one does not object to a grand piano or an upright piano. In many cases these instruments are seldom used, and the sounds emanating from them are rather amateurish compared with what one gets from the radio. One can argue on similar lines about other articles of furniture, and

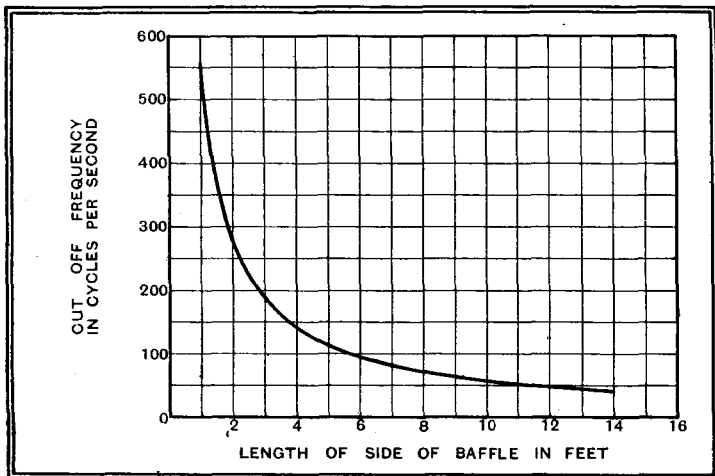

Fig. 4.—Curve showing cut-off frequencies of baffles of various sizes.

found that the power does not begin to fall off until 90 ~ is reached, one can conclude that there is probably a low frequency resonance.

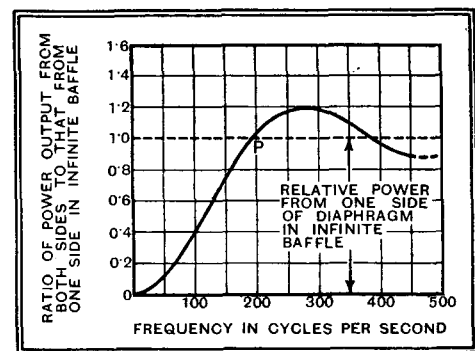

Fig. 5.—Curve illustrating decrease in power with a flat baffle (3 feet square) with fall in frequency. P is the cut-off point.

There is another effect introduced by a baffle, namely, there are spatial points where the output is a minimum. Referring to Fig. 3, it is seen that there is no sound on the axis of the diaphragm. This is due to the fact that at a distance of six diameters or more the sound from one of the tiny spheres, i.e. the crests and troughs, arrive simultaneously and balance out. With a diaphragm in a baffle, this ideal

varies from point to point in a room. Near the speaker the low tones may be weaker than they are in one corner of a room. In general, the sound absorption in a room increases with rise in frequency. Owing to reverberation the sound builds up, but the lower absorption in the bass register gives it an advantage over the upper register. Thus a speaker giving perfect reproduction in free air would give too much bass in the average room. In fact, a characteristic of the form illustrated in Fig. 7 would be obtained, and this is not too pleasant for listening purposes unless the output level is quite low.

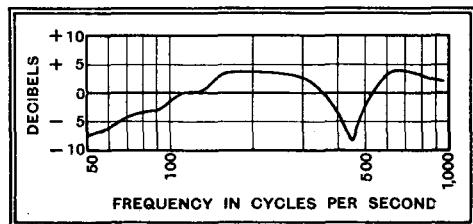

Fig. 6.—Curve showing interference effect on axis of 4ft. baffle.

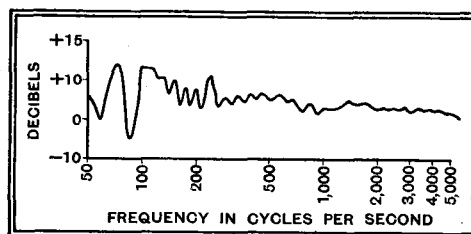

Fig. 7.—Curve illustrating increase in low-frequency output of loud speaker due to room effect.

varies from point to point in a room. Near the speaker the low tones may be weaker than they are in one corner of a room. In general, the sound absorption in a room increases with rise in frequency. Owing to reverberation the sound builds up, but the lower absorption in the bass register gives it an advantage over the upper register. Thus a speaker giving perfect reproduction in free air would give too much bass in the average room. In fact, a characteristic of the form illustrated in Fig. 7 would be obtained, and this is not too pleasant for listening purposes unless the output level is quite low.

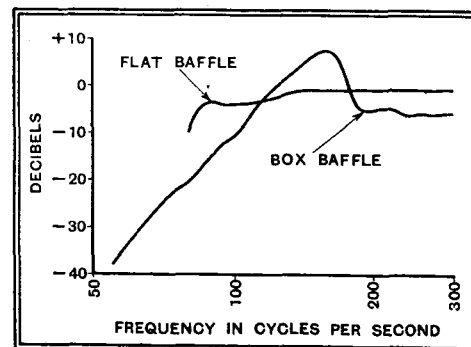

Fig. 8.—Type of resonance introduced by a box baffle.

Loud Speaker Baffles—

there seems to be no real reason why size—within reasonable limits—should matter where speakers are concerned, so long as the design is pleasing to gaze upon.

This brings us to the vexed question of box baffles. Unfortunately the box acts as a short organ pipe. This effect is illustrated in Fig. 8, and the reproduction is never so good as that with a flat baffle. One may improve matters by introducing absorbent material in various ways, and various patents have been taken out with this object in view. Patent 209,761 states that "In order to prevent the two sound waves which start from the two sides of the diaphragm, and which are displaced in phase by 180 deg., from meeting anywhere in space and producing disturbing

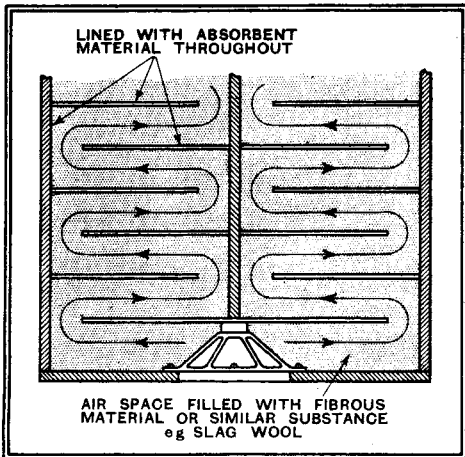
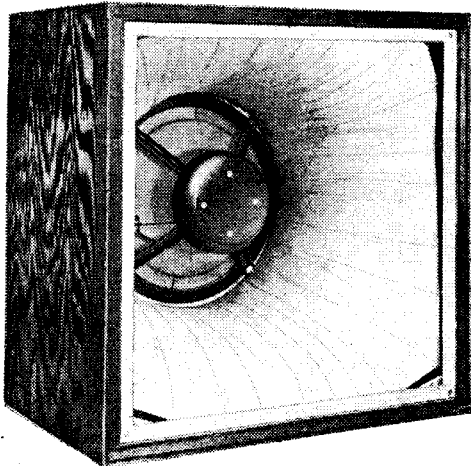

Fig. 9.—Suggested form of baffle in accordance with Patent 270,421. Instead of the passage being zig-zag it can be spiralled, or in effect an absorbent coiled tube of uniform or expanding section can be used.

interferences, the diaphragm may be closed on one side by means of an adjustable chamber." If this is carried out to the letter, the back of the diaphragm is substantially sealed by a box, and due to the cushioning or spring effect of this box there will be a low-frequency resonance. The larger the box the lower the frequency of the resonance. If the resonance occurs at 50 ~ there will be a full bass register round that frequency, although there is a falling off on either side due to



The Howe box baffle, the inside is packed with absorbent material as shown in Fig. 10.

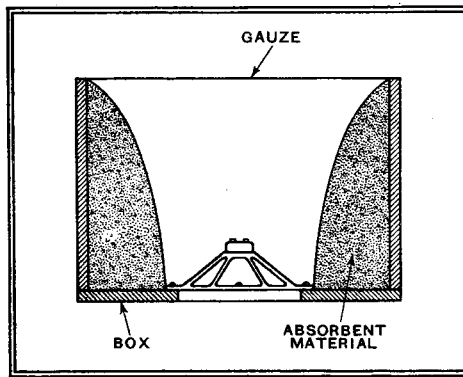

Fig. 10.—Sectional diagram of the Howe box baffle.

the usual "tuning" effect. Bass obtained in this way tends to be woolly and boomy. It is not so good as that with a large flat baffle six feet square. The resonance can be flattened out by lining the box with some form of absorbent material, e.g., "Acousti-Celotex."

Concerning absorption, Patent 270,421 states "The enclosure may contain a series of separated layers of finely perforated fabric, the perforations and the thickness and spacing of the layers being graduated if required; or it may be filled with expanded fibrous material; or it may have ducts, perforations or the like separately or in addition to the foregoing, in order to prevent resonance of the air in the enclosure. The perforated fabric and the expanded fibrous material also assist in isolating the two sides of the diaphragm."

One form suggested by the above is illustrated in Fig. 9. Without absorbent material the ducts might introduce air column resonances, and they would have to be thick enough to avoid appreciable vibration (like diaphragms). It is not the author's intention to raise any controversy on the subject of box baffles, so that the merits or otherwise must be left to the reader to decide by experiment. We may observe, however, that Fig. 10 illustrates one form of box baffle which gives pleasing results. Actually it is equivalent to a short horn made of absorbent material.

This brings us to what is sometimes called the "directional baffle," which is merely another name for a horn used with a large diaphragm. Since the dimensions at the mouth of a horn depend only upon the length of the longest sound wave to be reproduced (wavelength in feet = 1,120 divided by the frequency), at full strength, the larger the diaphragm the shorter the

horn. If the horn is four feet long or less it is sometimes regarded as a "flare." There is a difference between merely isolating the two sides of a diaphragm from each other's influence by means of a box, and using a horn. In the one case the sound waves spread over a very wide angle, whereas in the other they are prevented from doing so until the mouth of the flare is reached. The net result is that the diaphragm is loaded fairly heavily with a horn or flare but not with a box. Hence the power increases considerably when some form of "flare" or box baffle with an internal flare like Fig. 10 is used, provided it is not too short.

The Acoustic Load

The loading is determined by the "solid" angle into which the diaphragm discharges and by the rate of flaring. To understand what is meant by solid angle consider Fig. 11. The plane angle PON is said to have 90 degrees or $\pi/2 = 1.57$ radians. Now if the quadrant PON is rotated about the line ON, the resulting figure is a hemisphere, and since it is solid, the angle at O is regarded as a solid angle. The area of the hemisphere is $2\pi r^2$, and the solid angle is defined to be the area divided by r^2 , so it is 2π . In like manner the solid angle of a sphere is 4π . Thus, when a diaphragm is used in a box baffle where the sound from the back is suppressed by one of the methods described above, it discharges into a solid angle 4π .

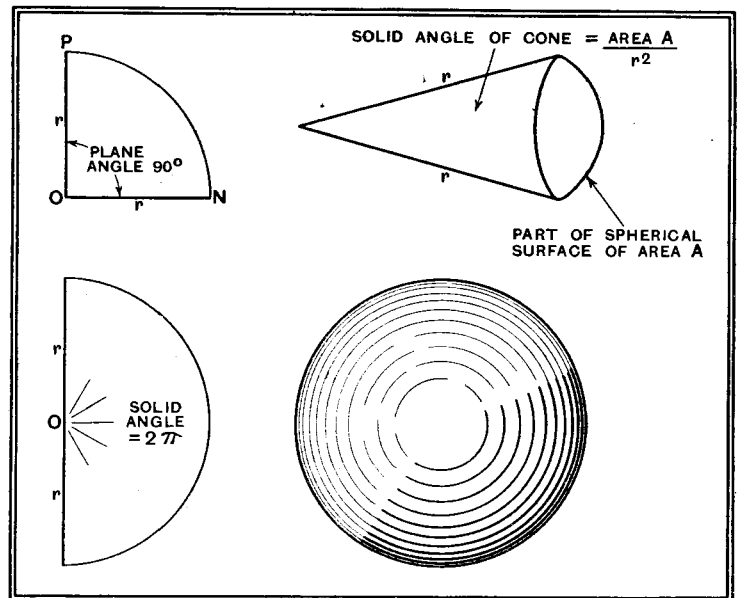

Fig. 11.—Illustrating what is meant by a "solid" angle.

The loading and, therefore, the sound output at low frequencies is less than that when an infinite baffle is used and the diaphragm discharges into hemispherical space of solid angle 2π . In fact, the power radiated from each side is now twice that under the condition where the rear of the diaphragm is screened. As the solid angle is still further reduced the loading increases until the maximum value is reached, when an infinitely long cylindrical tube is used. This is no good in

Loud Speaker Baffles—

practice, since the sound has to be discharged into the room, so the tube is made to flare out gradually. When a diaphragm is fully loaded (in an acoustical sense) by a horn, the bass register is crisper and cleaner than that obtained by using any other form of baffle. To reach 40 ~ the horn must be ten feet or more in length, and its sides must be thick to avoid vibration.

A few suggestions for experiments may not be amiss. Have you a spare fireplace? If so, mount your speaker on a thick board which will fit securely on to the front of the fireplace. Pull down the damper or block up the chimney, then push the speaker into place and try it out. Repeat the process with the chimney open to see if it resonates like an organ pipe. The music may attract birds or insects! The effect of putting absorbent material in the fireplace may then be tried.

Thin baffle boards vibrate violently at low frequencies, whereas baffles should be rigid. If you can't put a hole in the wall

or in a door, or if a serving hatch is not available, go to an auction room and purchase a thick-battened table and use this. Alternatively, buy a piece of ordinary Celotex board 3ft. x 12ft. x ½ in. and cut it in half. Join the two halves, using three or four strong hinges, bolts, nuts, and washers, thereby making a collapsible screen six feet square. Cut a hole for the speaker near a bottom corner, and fix the central disc to the baffle (with a hinge) to act as a door when the hole is not in use. Do likewise at the centre of the baffle about two feet from the floor. To reduce the solid angle place the baffle at 90 deg. (or other convenient angle according to the room) to a wall and use some temporary form of support. Try the speaker first in one hole, then in the other, choosing suitable listening positions some distance away. The baffle may be unsightly, but it is collapsible and portable. During winter it might serve to keep draughts off or in summer to shield one from the sun. The experimenter could have his favourite film star painted on it!

in preparation, for the only channel allotted to her is a share of the 352.9-metre wavelength upon which the Norwegian common-wave stations and Valencia also work. It was further decreed at Lucerne that the Sofia station must use an aerial directed towards the east so as to minimise interference with other stations operating on the same wavelength. At the present time a 50-kilowatt transmitting plant is in course of erection at Sofia, and this should be able to take over the programmes before very long. The Norwegian relays and Valencia may then have to be transferred to another channel.

You may have noticed that Moscow's 500-kilowatt station is working just now on a wavelength 20 metres higher than was shown against its name in the official lists. The change, which is in the nature of an experiment, was made owing to the protests received by the U.I.R. from Radio Paris. The latter station is now quite clear of interference, but what the Finns think about the change I don't know. Moscow must come in pretty strongly in their country, and their only long-wave station, Lahti, works on 1,807 metres. Moscow's new frequency is now 171.9 kilocycles, and as that of Lahti is 166, the resulting heterodyne must be anything but jolly.

Dr. Goebbels, the German Minister of Propaganda, referred in a recent speech to his country's need for high-powered short-wave stations to form a link between the Fatherland and Germans living overseas. Within the next twelve months Germany will possess the most powerful and most

In Next Week's Issue

Linking the 1936 Monodial A.C. Super

to the
Push-Pull
Quality
Amplifier

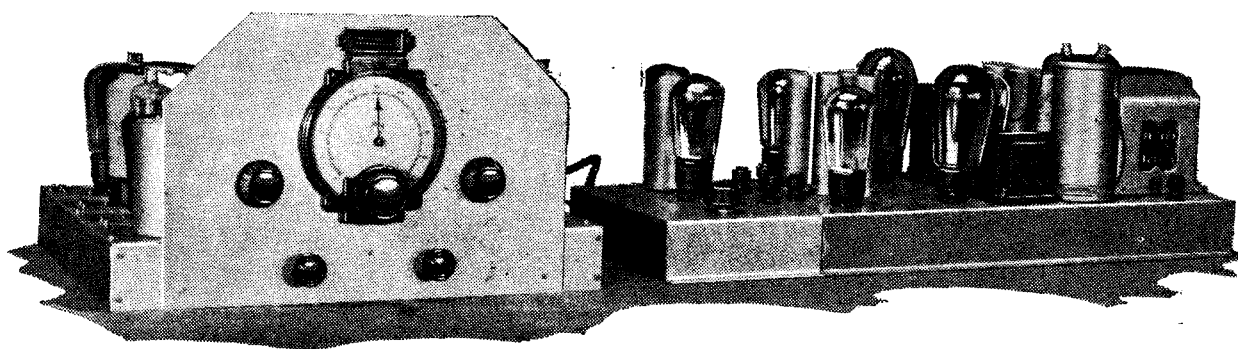

THE Wireless World Push-Pull Quality Amplifier has a deservedly high reputation among all who are interested in obtaining faithful reproduction, while the 1936 Monodial AC Super is a receiver which by virtue of its feature of variable selectivity is as suited to distant reception as to high-quality reproduction. These two in conjunction, therefore, provide ideal equipment for the music lover who wants something more than purely local-station reception, for they give him the sensitivity and selectivity necessary for distant reception together with the highest standard of reproduction which the prevailing interference conditions permit.

Minor Alterations Only

The modifications necessary to the 1936 Monodial AC Super for use with this amplifier will accordingly be fully described in next week's issue of *The Wireless World*, and it may be remarked that they are of a minor nature, involving only the addition of two resistances and two condensers with a change in value of one other condenser.

**DISTANT
RECEPTION NOTES**

BY this time you have probably heard the new Paris P.T.T. transmitter in action. Working on 431.7 metres, it has been taking over the evening programmes from the old 7-kilowatt plant. I understand that it is not yet working at full power, but is at present radiating at little more than half of the 100 kilowatts of which it will eventually be capable. The Paris P.T.T. station has always been pretty well heard in this country. It began, unless I am mistaken, with a 0.5-kilowatt transmitter at the Ecole Supérieure, the training school for technicians in the French Post Office service. Subsequently the power was increased first to 5 and then to 7 kilowatts. Even when using only a half-kilowatt the station was often heard in the more southerly parts of this country at good loud speaker strength after dusk.

Bulgaria is still the worst served country in Europe in the matter of broadcasting. Her only station, in fact, is the one-kilowatt Sofia. She could have had no broadcasting scheme in mind when the Lucerne Plan was

complete short-wave transmitting equipment in the world. It is proposed that news and talks shall be broadcast regularly in five languages—German, English, French, Italian and Spanish. I would I could think that the equipment would be used mainly for entertainment purposes.

Work is going on well at the new German long-wave station which will shortly replace the present 60-kilowatt plant at Zeesen. The new station, rated at 150 kilowatts, is to be equipped with an anti-fading aerial which should ensure its covering the whole of Germany—and probably the greater part of Europe as well—at all times.

Autumn conditions are more and more in evidence. Stations of which nothing at all was heard during the summer are reappearing, and the signal strength of the more distant Continental transmitters shows distinct signs of improvement. Within a very short time a score or more of stations should be receivable at a comparatively early hour in the evening. I am afraid, though, that some of those which I now hear well may experience heterodyne troubles as the field strength of their distant wavelength partners grows greater. It remains to be seen how some of the small wavelength changes that have been made during the summer will work out under autumn and winter conditions.

D. EXER.

HINTS and TIPS

THE amateur experimenter is usually content to check the working of the LF stage or stages of a receiver by some such simple expedient as the application of a finger to the grid terminal of each valveholder. However, it is sometimes

necessary, and at all times desirable, to have some more reliable indication that the full normal amplification is being obtained from each stage, and where AC mains are available the following simple device can be a useful addition to one's work-bench "properties."

It consists merely of a test lead terminating in an insulated prod, which is connected to the "live" side of the mains through a condenser of about 0.0005 mfd. capacity.

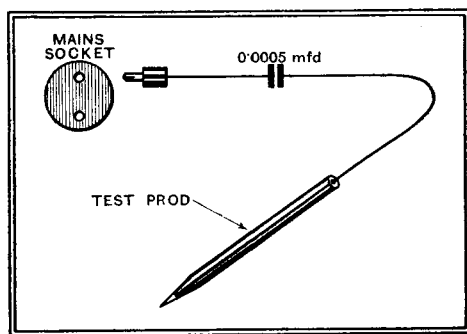

Fig. 1.—It would be difficult to devise a simpler "test oscillator" than this!

By applying this miniature "signal generator" to the grid of each valve in turn from the detector onwards, and noting that a corresponding increase in the loudness of the hum is obtained from each succeeding stage, the LF amplifier portion can be quickly checked. Thus an appreciable amount of the time otherwise spent in testing a receiver can be saved.

When dealing with the initial stages of high-gain amplifiers it is likely that the artificial signal applied in this manner may be excessively strong. Of course, the obvious way to reduce input is to use a smaller condenser, but in most cases the microscopic voltages needed are obtained by connecting the tester to the "earthy" side of the mains. By arranging matters as in the accompanying diagram this can easily be done.

WITH the tendency of receivers to become more and more sensitive there is a strong temptation nowadays to make shift with the shortest and most inefficient of aerials, provided that the reception of a number of the more worth-while

Aerials and Economy

stations appears to be satisfactory. Nevertheless, the practice of operating a receiver continually under these conditions can only be deprecated,

PRACTICAL AIDS TO BETTER RECEPTION

for on any but the most powerful station the background noise caused by the variable- μ amplifying valves working at almost maximum gain must be unpleasantly high.

Although in this respect the mains set owner will admittedly be the worst sufferer, battery users are reminded that, the anode current of a variable- μ valve being roughly proportional to its amplification, the total HT consumption is also likely to be unnecessarily high. Therefore, in the interests of battery economy, it is always advisable to erect a large and reasonably efficient aerial whenever it can conveniently be arranged, bearing in mind that the better the aerial the more easily will every station be received and the less will be the amplification required.

ALTHOUGH by no means new, the idea of making use of a crystal detector for systematic fault tracing can be very useful when dealing with the HF or IF stages of a modern superheterodyne. The crystal, which should be of the permanent

Crystal Fault Detector

type, is connected in series with a pair of 'phones, as shown in Fig. 2, the 'phone leads terminating in a pair of insulated prods or crocodile clips for convenience. Instead of a crystal detector, a WX type Westector should serve the purpose equally well, and should be much more reliable.

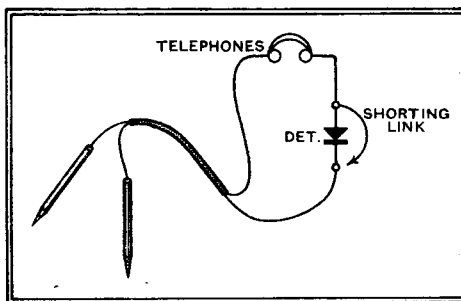

Fig. 2.—Method of using a crystal or Westector for stage-by-stage tests of HF circuits.

Assuming a post-mortem to be in progress on a receiver which completely fails to receive signals, the experienced fault-finder will presumably have already satisfied himself by a simple preliminary test that everything is in order from the second detector onwards. With the set switched on and connected to the aerial, the

"detector" prods are now tried in turn across the respective grid and anode circuits, commencing at the first tuned circuit which produces a signal—not necessarily the aerial circuit, for outside the service area of a B.B.C. station signals are likely to be too weak to operate the detector without amplification—and working towards the second detector. When a point is reached beyond which there is no further response from the 'phones, it is clear that the fault lies between this point and the stage last tested; it should now be a matter of but a few moments to locate the defective component.

To check the functioning of the oscillator valve and its associated circuits is a simple matter, for the fact that tunable broadcast signals can be heard with the detector across the primary of the first IF transformer is itself convincing proof that frequency changing, and hence oscillation, is taking place—a far quicker method than the one usually advocated, which necessitates breaking the anode circuit to insert a milliammeter.

If a short, flexible lead fitted with a crocodile clip be attached in the manner shown in the diagram, the detector may remain permanently inserted in one of the 'phone cords and be short-circuited when not required.

WHEN the consequences of a possible breakdown in a fixed condenser are likely to be exceptionally serious, equally exceptional precautions should be taken to minimise the risk. Failing a condenser with an enormous factor of safety with regard to its rated working voltage, one of the natural and obvious things to do is to connect two ordinary condensers in series.

Series for Safety

But, as has already been pointed out in these columns, a pair of similar condensers connected in this way must not be expected necessarily to withstand twice the normal working pressure. Actually, the applied voltage is distributed between them in proportion to their leakage resistance. Nevertheless, the series connection of two condensers, either one of which would normally withstand the working voltage, is a practical precaution that may be considered, especially when mica condensers, which usually have low leakage, are in question. In all such cases, however, it is wise to make a test—even if it is only a rough comparative one—of insulation resistance.

Current Topics

Events of the Week in Brief Review

French Listening Post

A FRENCH official listening centre has been opened in Paris. A wide range of receiving equipment has been installed to enable a watch to be maintained not only on the French national transmissions but those from all European countries. Logs will be kept to record transmission quality and wavelength constancy.

Listening to Moscow

THE foreman of a shoe factory at Marienwerder, Prussia, was recently dismissed for "listening in to Moscow," and when he sued the firm for damages in respect of unlawful dismissal, lost the case. The Court dismissed the claim on the ground that "listening to Moscow is calculated to shake the confidence which ought to subsist between employer and staff."

A new Austrian law has been passed which forbids owners of wireless sets to permit strangers to listen to programmes inimical to the national interests. The penalty is a fine not exceeding 2,000 schillings or three months' imprisonment.

Wireless Classes

THE evening classes season is now opening and residents in the London area have a good choice of courses and lectures in radio and television.

Courses in wireless and high-frequency engineering, including television, begin at the Polytechnic, 307-311, Regent Street, London, W.1, on September 23rd. The head of the department and his staff will be in attendance to advise and enrol students on September 16th to 20th from 6 to 9 p.m. The laboratories include a complete installation for telegraphy and telephony (G6RA).

September 23rd has also been chosen as the opening date for the radio and television classes of the Borough Polytechnic, Borough Road, London, S.E.1. Full particulars are obtainable from the Principal.

A short course of five lectures on television will be given at the L.C.C. School of Engineering and Navigation, High Street, Poplar, E.14, beginning on October 7th. Lectures will be illustrated by experiments and demonstrations.

Courses in electricity and magnetism and in alternating current work are included in the Physics curriculum of the Sir John Cass Technical Institute, Jewry Street, Aldgate, E.C.

No Bulgar Amateurs

THE Bulgarian State having taken over the control of radio, the use of private transmitting stations has been forbidden.

Brussels to Check U.S. Wavelengths

THE Brussels wavelength monitoring bureau of the International Broadcasting Union is to be considerably enlarged. New apparatus is to be installed which will make it possible not only to keep watch on European transmitters but on a number of the North American stations. Wavelength and modulation will both be studied.

Where Scotland Lags

SCOTLAND is not a good patron of the radio trade, to judge from calculations made

Two Million

FRENCH receiving licences passed the two million mark in July, and on the 31st of that month the official figure was 2,900,737. The Paris Region, which includes a considerable number of Departments, contains 893,957 registered listeners.

Esperanto and Radio

THIRTY deputies have introduced a proposal in the French Parliament that the teaching of Esperanto in schools should form part of the national education. One of the reasons advanced in support of the scheme is the growing use of the international language in wireless.

Making Broadcasting Safe

THE fact that nearly a dozen engineers and operators at broadcasting stations have been

Short Waves from Japan

A SPECIAL overseas broadcast from Europe is now radiated from Tokio JVH (14,600 kc/s) or JVM (10,740 kc/s) on Wednesdays and Fridays between 7 and 8 p.m. (G.M.T.). Reports will be welcomed by Kokusai-Denwa Kaisha, Ltd., No. 3 1-Chome, Uchisaiwaicho, Kojimachiku, Tokio, Japan.

Stealing a Death Ray

A "DEATH-RAY" story in the Danish Press is of particular interest, as it concerns an engineer, Mr. Chr. Hansen, who was recently invited by the British R.A.F. to demonstrate his apparatus for stopping aircraft engines within a radius of 125 miles.

According to the Danish newspapers, Mr. Hansen, just before starting for England, was the victim of a robbery, all his plans and apparatus being seized. The Danish police are now pursuing the culprits, who are believed to be working for "a foreign Power."

Recorded Programmes in U.S.

A VAST scheme of "bottled" programmes is being instituted in America. The original studios of the National Broadcasting Company in Fifth Avenue, New York, are being taken over by the World Broadcasting System, and famous artistes will once more use what has been a derelict building. The only difference will be that instead of their performances being broadcast, these will be recorded for duplication and despatch to stations throughout the country for broadcast by the "delayed," or transcription, method.

U.S. Ultra-short-wave Ban

ULTRA-SHORT-WAVES are banned for commercial use in America by the latest ruling of the Federal Communications Commission, which has decided that transmission on the ultra-high frequencies must be limited to experimental laboratories for another year. Actually there are, according to a correspondent, 991 individuals and organisations in the United States holding licences for ultra-short-wave tests.

In an official statement, the Federal Communications Commission says that its policy has been to proceed with caution, strictly maintaining the experimental status of the ultra-high frequencies until such time as all requisite information is available.

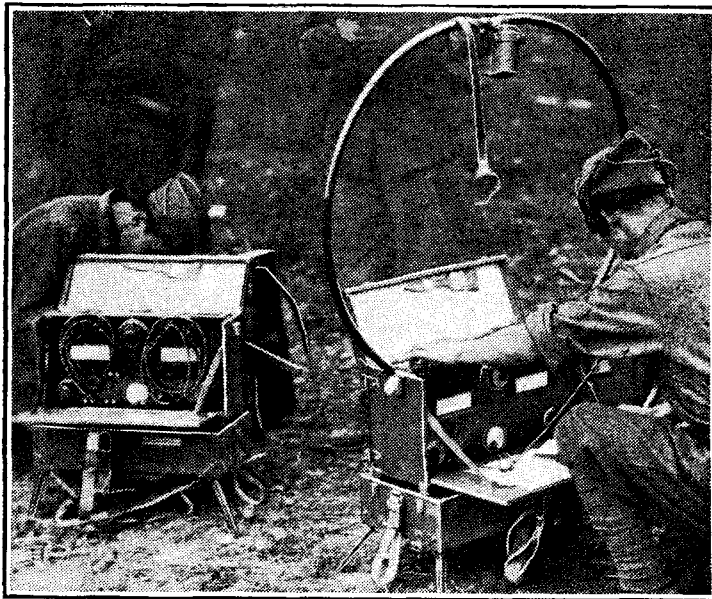

WIRELESS IN THE ITALIAN ARMY. The land of Marconi's birth is making full use of radio as an aid to army operations. This picture was taken during the manoeuvres at Bolzano. The signallers carry the sets on their backs.

by the manufacturers in connection with the Glasgow Radio Show. During the past year the Glasgow people have been buying receivers at the low rate of seven per hour, while only three per hour is the figure recorded for Edinburgh, where 82,832 families have radio sets as compared with 139,311 in Glasgow.

The total number of licences in Scotland is less than in three English cities. Liverpool, Manchester and Birmingham have between them 598,511 set owners, while the whole of Scotland has only 576,650.

killed by unsafe equipment during the last ten years has led the United States Federal Communications Commission to recommend a rigid "equipment clean-up" drive, writes our Washington correspondent. It has been found that in many stations little attention is being paid to the safety-of-life factor. High-voltage leads are often exposed. The new regulations will require standardised methods of installation and wiring, and about one-third of America's six hundred stations, it is estimated, will find adjustments necessary.

Superheterodyne Whistles

Modern Practice Reveals an Unsuspected Source of Interference

By M. G. SCROGGIE, B.Sc.,
A.M.I.E.E.

IT is not generally realised that harmonics of the intermediate frequency can be responsible for many of the whistles popularly known as second-channel interference. The mechanism of their production is explained in this article together with the remedies which must be adopted.

HF input is enough to cause a whistle whenever the frequency to which the re-
IF = 110 kc/s.

Harmonic.	Frequency.	Wavelength.
	Kilocycles/s.	Metres.
Fundamental	110	2,727
2	220	1,363
3	330	909
4	440	682
5	550	545
6	660	455
7	770	390
8	880	341
9	990	306
10	1,100	273
11	1,210	248
12	1,320	227
13	1,430	210

AT one time, not so very long ago, all whistles in superhet receivers were "Second Channel." As requirements became more and more intolerant of extraneous matters such as whistles, these troubles were more closely investigated, and it was realised that second-channel interference is just one of many causes of whistles. Oscillator harmonics may be far more prolific. And there are still many other varieties of whistles.

At least, that would be so were it not for harmonics of the IF, a good many of which do come within the wave-ranges of broadcast receivers.

IF Harmonics

The Single-Span type of superhet avoids this trouble completely by making the IF higher than any frequency to which the set can be tuned; as harmonics are inevitably higher in frequency than their fundamental, they are *a fortiori* excluded.

Valve and circuit design have progressed towards eliminating these pests. But there is one source of them, now to be described, that may even be encouraged by modern tendencies in design, and at its worst it is a truly terrible disease, covering the whole of the medium waveband and part of the long with whistles.

But here we are assuming the more usual IF in the regions of 110-130 or 460-480 kc/s. Taking, for the sake of example, 110 and 465 as representative frequencies, the following table gives the frequencies and wavelengths of the harmonics having a lower frequency than 1,500 (or above).

IF = 465 kc/s.

Harmonic.	Frequency.	Wavelength.
Fundamental	465	645
2	930	323
3	1,395	215

There is at present a definite trend towards what may be termed high-amplitude detection. The diode detector feeds straight into the output stage, without the interposition of a LF valve, and the amplification in the HF and IF stages is correspondingly increased to give to the diode the necessary signal strength, which may be 10 volts or even more. Remembering that the power is in proportion to the square

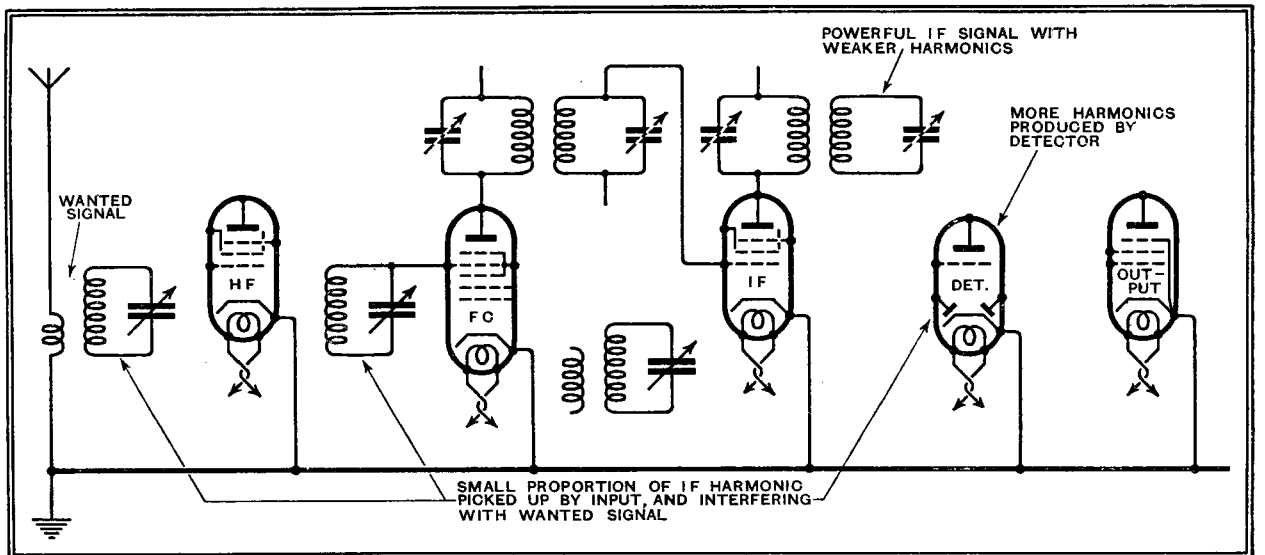

Fig. 1.—Diagrammatic illustration of IF harmonic interference.

of the voltage, it is clear that in a "straight" set it would be difficult to confine this detector signal so strictly that not one-billionth part of it could find its way to the aerial end of the receiver. Assuming that the sensitivity is of the order of 10 microvolts, this minute leakage is enough to cause instability. The advantage of the superheterodyne principle, of course, is that it does not matter how much of the detector signal does escape; it is at a frequency (the IF) to which the aerial end of the set is not sensi-

200 metres in wavelength). Those in heavy type come within the usual tuning ranges of a broadcast receiver.

All of these harmonics are present to some degree in the IF signal given to the second detector. Unless the receiver is badly designed, or misused, the proportion of harmonics should be low—less than 1 per cent., anyway. But even a tenth of 1 per cent. of 10 volts is 10,000 microvolts; and if the receiver is sensitive to, say, 10 microvolts, a very small stray coupling between the IF output and the

ceiver is tuned approaches the frequency of any of the harmonics.

Note, too, that the frequency of the harmonic depends not on the designed IF of the receiver, but on the actual IF signal which happens to be present. Suppose the receiver is designed for 110 kc/s. Then when it is *exactly* tuned to a station, the oscillator is (or should be) 110 kc/s higher in frequency in order to give a heterodyne frequency of that amount to go through the IF amplifier. If the receiver is mistuned slightly, the oscillator

Superheterodyne Whistles—

frequency is altered, while the station frequency remains fixed (of course), so that the actual IF is now different from 110. Bearing this in mind, it will be easy to follow the typical conditions now to be tabulated, which explain the formation of whistles at practically any setting of the tuning control.

The Conditions for Interference

Suppose, first, that we are exactly tuned to a station working on a frequency of 1,100 kc/s. The oscillator frequency is 1,100 + 110, or 1,210 kc/s, and the difference between 1,210 and the station frequency (1,100) obviously is 110. This,

observed on each side of the exact tuning point in an oscillating receiver, except that the note of the whistle rises ten times as fast. In fact, it has vanished altogether before the tuning has been disturbed enough to lose the wanted station; so that one method of avoiding the interference is obvious. Some receivers are so selective that even a slight mistuning may seriously affect the tone, and in any case the sound of whistles as one turns the tuning knob creates a very bad impression, even if it is avoidable when stationary.

And, furthermore, the whistle vanishes thus rapidly only with the highest harmonics, which are the weakest and least troublesome in any case. One cannot

frequency than the normal harmonic have a whistle slightly displaced on the high-frequency side of exact tuning. The figures also show that, under the conditions chosen, the mistuning is not great enough to tune out the harmonic appreciably. In fact, if the IF amplifier has a double-peaked response, the harmonic may actually be strengthened.

Now consider what happens when the receiver is tuned to a station several channels away. In line D it is taken almost midway between 10th and 11th harmonics. To get a whistle the receiver must be mistuned by 4.5 kc/s, which, except in a "high-fidelity" model, is likely to weaken the response very greatly. By this time, if harmonics are so bad as still to be heard, the 11th will be picked up by mistuning the other side of the station frequency.

The Long Waveband

Such a condition is actually observable in some receivers. The result one gets, on tuning slowly over the whole medium waveband at a time when stations can be heard on every channel, is that, as each station in turn is picked up, the corresponding whistle comes more and more nearly dead in tune, and at the same time is stronger. When whistles due to one harmonic are progressively lost at one side of tuning point, those due to the next appear on the opposite sideband.

The audibility of whistles depends, apart from the factors already mentioned, on the strength of the signal from the station. If the signal is extremely weak, so is the whistle. The two increase together more or less in proportion; rather more than less, so far as the whistle is concerned, for the percentage of harmonic tends to increase with greater signal amplitude. When the signal is just strong enough to give full output, but just not enough to overcome the AVC delay voltage, the whistle reaches its zenith. Stronger signals apply AVC bias, and so reduce the sensitivity of the IF amplifier; the proportion of whistle then steadily decreases.

The effect on the long waveband may be pronounced even when the medium band is quite free. Although only one harmonic falls above 1,000 metres, it is, in general, much stronger than the others. The whistle extends over a wider sweep, and usually

spoils Luxembourg, and perhaps others. It may even be so bad as to introduce quite a different manifestation; it may be picked up so strongly by the input end of the receiver that, with or without the presence of an incoming programme, it may result in instability. Growling or

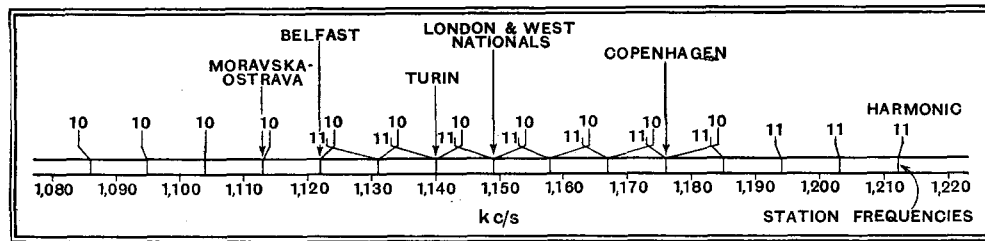

Fig. 2.—A short section of the medium-wave frequency band, showing the actual location of stations according to the Lucerne Plan, and the relative positions of 10th and 11th harmonic whistles, assuming 110 kc/s IF.

therefore, is the frequency of the IF signal, and its 10th harmonic is 1,100 kc/s, which happens to coincide with the frequency to which the receiver is tuned (and to which it therefore has maximum response), and also with the frequency of the station. So there is zero beat note. The interference does not set up an audible whistle, but if it is of appreciable strength it is likely to muddle up the reception to some extent. And the slightest mistuning either side produces a whistle, as we shall now see. The first condition, just described, is marked A in the table. Actually, there is no station working on exactly 1,100 kc/s at the present time; the even figures are chosen for simplicity.

Designed IF = 110 kc/s.

Con- dition.	Station Fre- quency.	Fre- quency to which Tuned.	Oscil- lator Fre- quency.	Fre- quency of IF Signal.	Fre- quency of 10th IF Har- monic.
A	1,100	1,100	1,210	110	1,100
B	1,100	1,100.1	1,210.1	110.1	1,101
C	1,109	1,099.9	1,209.9	109.9	1,099
		1,110	1,220	111	1,110
D	1,145	1,109.8	1,219.8	110.8	1,108
		1,149.5	1,259.5	114.5	1,145

Now look at line B. The station is the same, but the receiver tuning is altered by 0.1 kc/s, or only 100 cycles—quite a negligible mistuning. Both upward and downward adjustments are shown. The IF signal, being only 0.1 kc/s off tune, is perfectly acceptable to the IF amplifier, which produces a harmonic frequency 1 kc above or below that of the station. This heterodynes with the station signal to give a 1,000 c/s whistle. The effect is similar to the rising whistle that is

readily escape the 2nd harmonic by mistuning.

Up to the present we have seen how a harmonic whistle is found sitting on the top of every station whose frequency is a multiple of the IF, if it is strong enough to be audible. Assuming the usual 9 kc/s spacing and 110 kc/s IF, that affects about one station in twelve. What about the stations in between? Condition C in the foregoing table assumes a station one channel away from the harmonic fre-

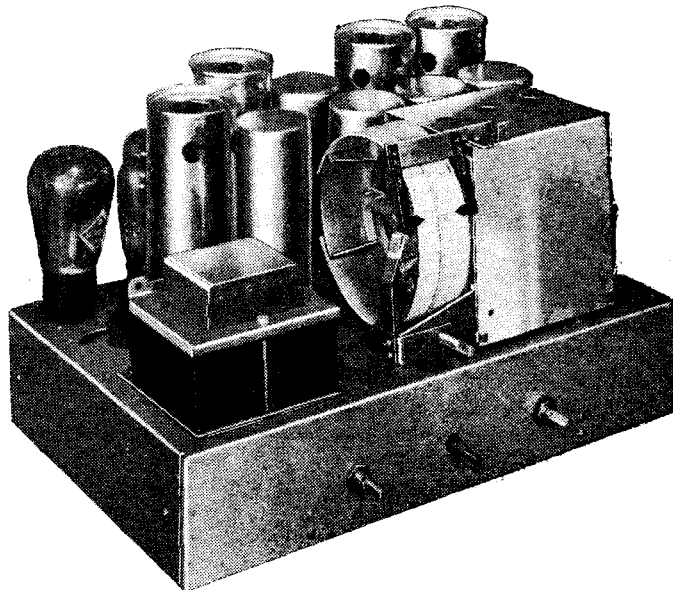

An early superheterodyne in which very extensive screening was adopted.

quency. From the explanation that has just been given, it is clear that there is no whistle when the receiver is exactly tuned to the station. But by mistuning only 1 kc (slightly more or less) a harmonic is produced that interferes. As the figures show, stations that are higher in

Superheterodyne Whistles—

motor-boating at this point is not uncommon.

That is the cause and effect. Now for the cure. One cure, or, rather, a limited palliative, has been mentioned—slight mistuning. To get more to the root of the matter steps should be taken to prevent excessive harmonics from being generated. The ob-

supposed to be safely short-circuited by the filter between the detector and the next valve. The harmonics at this stage are relatively so strong that, in spite of the filter, they may be the main cause of trouble. This is shown by practical tests in which the detector heater is disconnected. When it cools down, most of the harmonic interference (picked up on a

aerial itself is bound to be open (unless a screened down-lead, anti-interference system is used); but, as the coupling from the aerial is generally fairly loose, there is some point in screening the input tuned circuits. When a HF stage is used, this must be done in any case, but otherwise it is sometimes considered unnecessary. Open pre-selector coils are almost certain to pick up IF harmonics, however, so screening is justified on this ground alone.

As an alternative to complete screening, or in addition to it where the trouble is particularly refractory, one may use a filter in the lead from the last IF coupling. This is easy to arrange only if a tuned anode coupling is employed, which itself is a less efficient harmonic suppressor than a transformer. A simple acceptor circuit has been tried and found successful (Fig. 4). It must be mounted within the IF screen, of course. For 110 kc/s the coil may be a 50,000 microhenry choke, preferably iron-cored, and the condenser about 50 μ F. This passes the fundamental quite freely, but impedes all harmonics. Of course, it is not helpful when most of the interference emanates from the detector.

With care, even a high-amplitude detection receiver can be free from all perceptible IF harmonic interference on the medium waveband. It is more difficult to make the second harmonic whistle vanish—even with low-amplitude detection—but it can be made inoffensive.

The writer suggests that the method of measuring this particular brand of interference with a standard signal generator might be thus: With a weak unmodulated signal from the generator, adjust the tuning of receiver and generator simultaneously to get the strongest whistle from a particular harmonic. Then bring up the generator signal until the maximum whistle is registered on the output meter (this ordinarily takes place, as explained, just before the AVC comes into effect). Note the input and output. Now reduce the generator signal and modulate it to the standard depth (30 per cent.), adjusting the signal to give the same output as before. The ratio between the first and second signal strengths is a basis for comparing whistle interference.

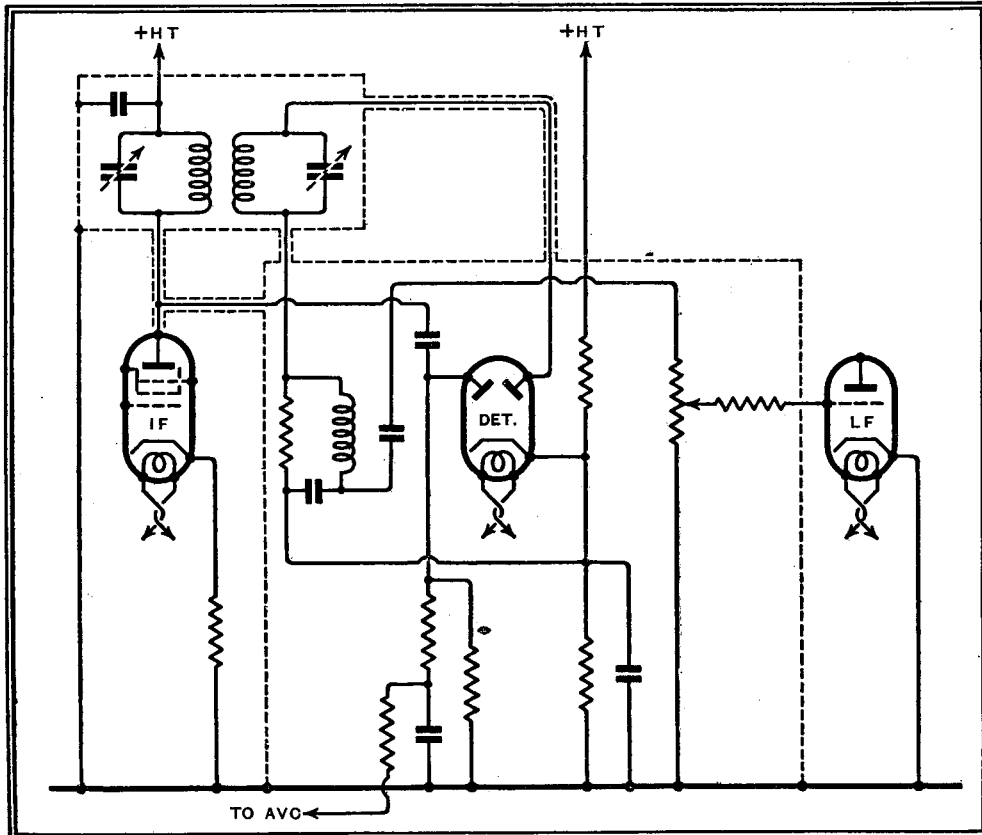

Fig. 3.—The circuits carrying the strongest IF harmonics are shown here, together with the screening necessary to prevent them from causing interference.

ject of using a screened pentode for the last IF stage, rather than a tetrode, is to be able to handle a large signal amplitude in the type of receiver under discussion. The SG tetrode can handle only a relatively limited amplitude without harmonic distortion. But whatever valve is used, care must be taken to ensure that it is working under correct conditions—screen voltages, for instance. The condition that usually causes designers to worry about harmonic distortion is the application of a very strong signal, when the valve is called upon to give full output with a large negative bias on the grid. But although such a condition does certainly encourage harmonics, it need not concern us at the moment, because the amplification is then too low to give any prominence even to an excessive harmonic.

However much may be done to obtain a practically pure waveform throughout the IF amplifier itself, there is always the detector to reckon with. Even a distortionless detector would be no use at all unless it distorted. It hands on the modulation waveforms undistorted; but its very object of rectification means the conversion of the pure IF waveforms into distorted forms consisting largely of harmonics. These, however, are *not* passed on; both fundamental and harmonics are

second receiver nearby) vanishes. Special attention, therefore, must be devoted to the filter. Unfortunately, it is difficult to design a filter that eliminates IF currents effectively without also robbing the high audible frequencies.

A certain amount of harmonics being inevitable, they must be confined within limits that do not extend to any sensitive part of the receiver. The IF transformer itself is, of course, always screened. It is customary to screen the high potential leads coming from it in braided metal sleeving connected to earth, and so that this shall not introduce excessive capacity the diodes and their associated components ought to be as close as possible to the transformer. It is wise to go so far as to enclose all the parts surrounded by a dotted line in Fig. 3 within a screen. Remember that the leads on the earthed sides of condensers cannot be treated as "earth," for they are very likely to be carrying heavy HF or IF currents. It is best to earth all these leads within such a unit to one particular spot on the chassis.

Even the best screening that is practicable in receiver construction is less than perfect, and we have seen how small a leakage may cause trouble. There may be need, therefore, to consider a second line of defence around the input end. The

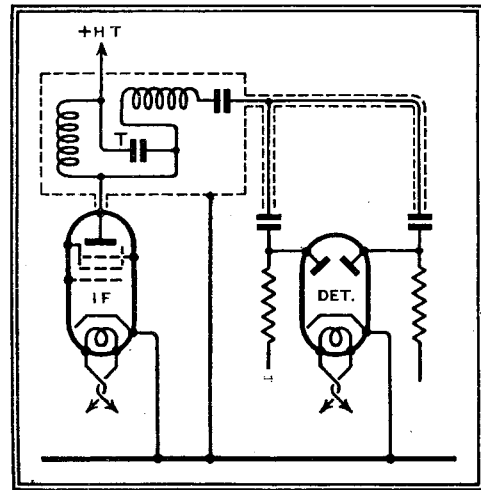

Fig. 4.—Simple filter for suppressing harmonics when single-circuit IF coupling is used.

500 KILOWATTS FROM FINLAND?

Discoveries on a Radio Tour of North-East Europe

By "WANDERING WAVE"

FINLAND is one of the seven countries which declined to append their signature to the Lucerne Plan—a fact which was forced on my attention a few days ago.

suitable site for a new 40- to 60-kilowatt transmitter. Estonia has as present two transmitters, one in the capital of Tallinn and a small relay station at Tartu. In the streets of the beautiful mediæval city I found workmen preparing the foundations for a new Broadcasting House to replace the existing studios in the National Theatre building.

Across the Gulf of Finland, 3½ hours by fast steamer or thirty minutes by air, lies Helsinki, capital of Finland, with its very modern and efficient broadcasting studios.

Very important power increases are now being pushed forward by the Finnish Broadcasting Company, and the transmitters are

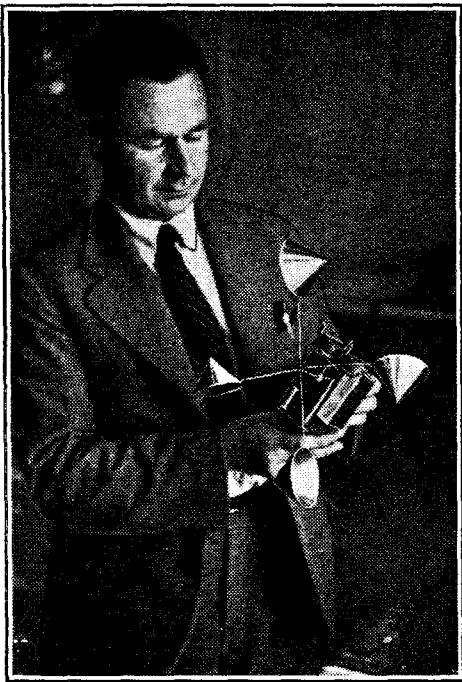

Dr. Vaisala, head of the Helsinki meteorological station, with one of his short-wave balloon transmitters used for indicating atmospheric conditions at high altitudes.

I had taken one of the Finnish steamers which visit both Tallinn and Helsinki, capitals of Estonia and Finland respectively. In the former city I found Lieut.-Col. Olbrei studying the results of field strength measurements made near Paide, close to the geographical centre of the country. Engineers are now seeking a

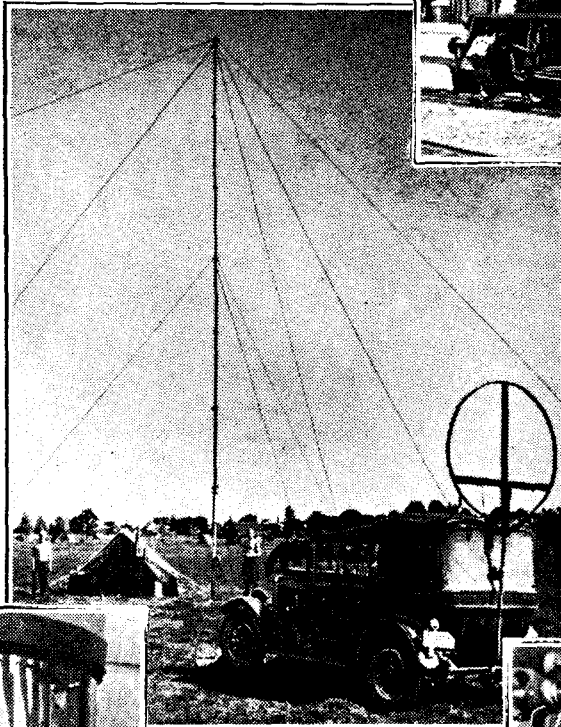

Lahti's new masts seen beyond the railway.

ing station, which is almost a replica of Droitwich. Tests are expected to begin in October, when this giant will replace the present 40-kilowatt transmitter. I found that the authorities are actually contemplating transmissions on 500 kilowatts, and as they are non-signatories to the Lucerne Plan it is possible that their fancies may be translated into realities. At all events, the transmitter building at Lahti is



Field strength measurements in progress at Paide, in the centre of Estonia.

(Left) A semi-circular window gives the drama producer at Helsinki a good view of the situation.

(Right) Helsinki's interval signal—a Finnish folk tune—is produced by this electro-mechanical music box.

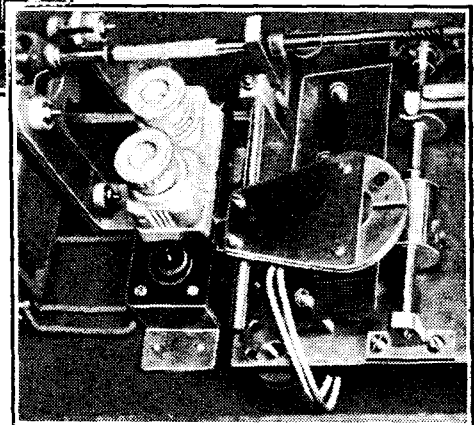

being modernised. British engineers are hard at work at Lahti supervising the installation of the new 150- to 220-kilowatt broadcast-

designed for apparatus double the power of that now being installed. Transmission is handicapped by thick forest all over the country.

Through German Eyes

English and German Techniques Compared

By H. J. WILHELMY

THIS article, by a German technician, has been written after visiting both the Olympia and Berlin Wireless Exhibitions. Although some of the author's views will not be allowed to pass unchallenged, the article presents an interesting picture of divergent tendencies in the two countries.

ALTHOUGH there is some measure of international standardisation in broadcast receivers, many very striking differences are to be observed, both in the design of their products and in matters of policy, between the British and German wireless industries.

The battery receiver, for example, has been developed much more intensively in England than in Germany. Some readers will be surprised to hear that practically the only battery operated superheterodyne manufactured in Germany is a suit-case portable. This in spite of the fact that

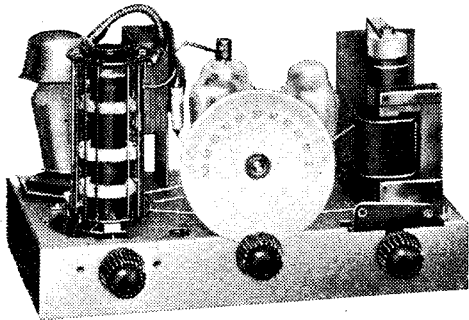

The "standard" German receiver embodies a 2-valve det.-LF circuit; this is a new AC/DC version of the "Volksempfänger."

suitable valves such as octode frequency-changers and variable-mu HF pentodes are now available in Germany, although they were hardly introduced in sufficient time for inclusion in the new season's models. It is concluded that the general neglect of battery sets by the German industry is due to the better national distribution of electrical supplies; be that as it may, I saw nothing in Berlin to compare with the many up-to-date battery sets and even public address equipment shown at Olympia.

The British wireless industry is also to be congratulated on the production of extremely compact receivers of the truly portable types: these we have completely neglected.

On the other hand, the simple and inexpensive det.-LF set, exemplified in Ger-

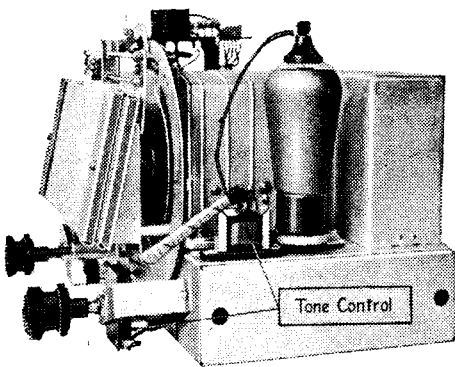

In this German receiver, tone control is effected by high capacity variable working in conjunction with a choke condenser.

many by the Volksempfänger, is hardly in evidence at all in England, and those few firms producing such sets seem almost to be ashamed of them. Possibly, however, such sets are not suitable for English conditions and requirements, and in any case production on the same large scale as that of the Volksempfänger is only possible under a system of unified control.

Simpler German Circuits

The "standard" receiver in Germany is not a small superheterodyne, but a det.-LF set comprising an HF pentode as a detector feeding directly into the output stage. These sets now give a remarkably good performance, and have a maximum sensitivity of about 400 microvolts.

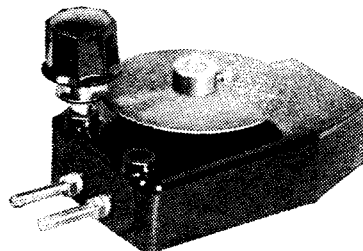

A plug-in wave trap seen at the Berlin Show; note reduction drive for the built-in tuning condenser.

The next most ambitious German set is an HF-det.-LF circuit with either pentode or diode-triode detector and pentode output. This set has replaced the small three-valve superhet which was first introduced by Germany, but elimination of its various shortcomings were found to increase cost too seriously.

These straight sets with two tuned circuits have been improved to a greater extent than elsewhere by using the latest iron-cored coils, ceramic insulation, and better circuit arrangements; it has been possible to simplify control, to improve selectivity, and to provide accurate calibration. Thus, the German designers have reached a point where the superheterodyne is no longer to be compared with the straight set in the matter of price. However, there are on the German market a few superhets, very similar to their English counterparts, comprising a frequency-changer, an IF stage with four

circuits, a diode detector and output pentode.

Triode-hexode frequency-changers, originated by our technicians but now abandoned by them, still seem to be widely used in England. Practically the only frequency-changer employed in the 1935 German superheterodyne is the octode, which seems to have less frequency-drift and better stability than any of the devices previously tried. Standardisation in this matter seems to be worthy of imitation by English engineers, who still persist in using various arrangements considered by us to be not entirely trouble-free.

Ambitious "high-fidelity" superheterodynes were to be found at both Shows, but we had nothing approaching such sets as the H.M.V. Model 800 radio gramophone. This, I think, is due to the matter of price limitations, which are more strictly imposed in Germany, where radio gramophones in general are too expensive to allow of their production on a large scale.

Iron-cored coils are used much more widely in Germany than in England. Although it may be possible to build a high-performance receiver with air-cored coils, iron-cored devices make the task

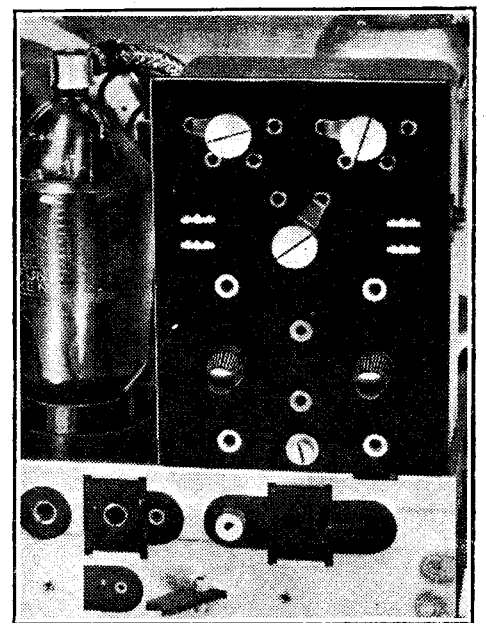

The elaborate wavetrap system in one of the new Telefunken receivers.

Through German Eyes—

much easier, particularly as their inductances can be matched much more accurately, and also they are so much more compact. Here, I think, the German practice is the better. It is noticeable, however, that we do not use the iron-cored coils where their properties would be wasted, as, for instance, in the oscillator circuit of a superheterodyne.

Low Loss Logic

British designers have not taken kindly to low-loss ceramic insulating materials. We strive to eliminate avoidable losses everywhere by using such material and also to provide better immunity from humidity. But some German designers may learn a lot from their English colleagues in avoiding the use of these expensive materials where they serve no useful purpose. For instance, it seems quite illogical to use ceramic valveholders for

ments, but it had nothing to match the universal or portable (car-battery) English amplifiers.

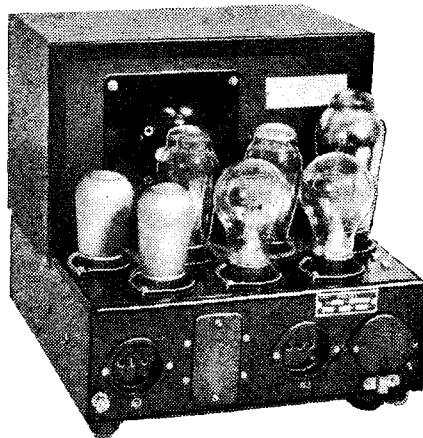

A Philips amplifier which operates normally for low-volume reproduction but converts itself automatically to the Class "B" system for large outputs.

coils seem to be our outstanding production, and it is also interesting to note that our amateur constructors have a much wider choice of large station-calibrated tuning dials than in England. But we lack such components as Westectors, and high-voltage Westinghouse rectifiers, and shaped-plate superhet condensers are not available; consequently, the padding condenser system is exclusively employed for "tracking" the oscillator circuit. I consider, however, that our ceramic short-wave and ultra-short-wave components are better developed.

I should like to try to compare English and German television, but was disappointed to find that this branch of our art was not represented at Olympia.

THE RADIO INDUSTRY

LIKE its predecessors, the new Dubilier list of condensers and resistances is an exceptionally useful and informative publication. This year's edition, prepared specially for amateur constructors and service engineers, contains information on the use of anti-interference devices, including a complete circuit diagram showing the fitting of suppressors to the electrical equipment of a car.

Ferranti, Ltd., Radio Works, Moston, Manchester, 10, have just issued a book (price 6d., post free) describing the construction of four amplifiers with outputs of 1, 2½, 6½ and 12½ watts. The first is a very economical battery-operated instrument embodying a QPP circuit.

As productions of a pioneer firm, it is natural that McMichael sets should get far afield. A Model 235 Superhet. has just been sold to the Sheik of Koweit, on the Persian Gulf.

The new season's programme of Universal High Voltage Radio has now been issued, and includes "straight" receivers as well as three "all-wave" superheterodynes. The most ambitious of the latter embodies nine receiving valves and has 2 IF stages, with push-pull output. Wavelengths between 15 and 1,900 metres are covered in four steps, and output is rated at 6-7 watts. Address, 28/29, Southampton Street, Strand, London, W.C.2.

With the object of conducting research and development work in connection with valves, etc., a company has been formed under the style of Harries Thermionics, Ltd., of Avenue Chambers, Vernon Place, Southampton Row, W.C. The new organisation will not engage in manufacture, but will issue licences for the commercial exploitation of its productions. Mr. J. H. Owen Harries, a director, is responsible for the development of a novel output valve, recently described in these columns, which is now being manufactured by Hivac.

Sifam Electrical Instrument Co., Ltd. has moved to larger premises at Hollydale Road, Queen's Road, London, S.E.15.

A Belling-Lee interference suppressor (Type 1211), designed for insertion in the mains lead feeding a receiver, is described in a leaflet just issued by Belling and Lee, Ltd., Cambridge Arterial Road, Enfield, Middlesex.

The new address of the National Radio Engineers' Association, Ltd., is 114, City Road, London, E.C.1.

Henry Ford Radio, Ltd., of 56, Howland Street, London, W.1, are prepared to undertake the alignment of the circuits of the new Monodial receiver; the firm is suitably equipped with oscillators for this purpose.

With regard to valves, the most important of components in any wireless set, England has many interesting types not to be found in Germany. For instance, the 2-volt battery series is more complete, as we lack Class "B" and double-diode-triode types in this series; also we have no midget valves.

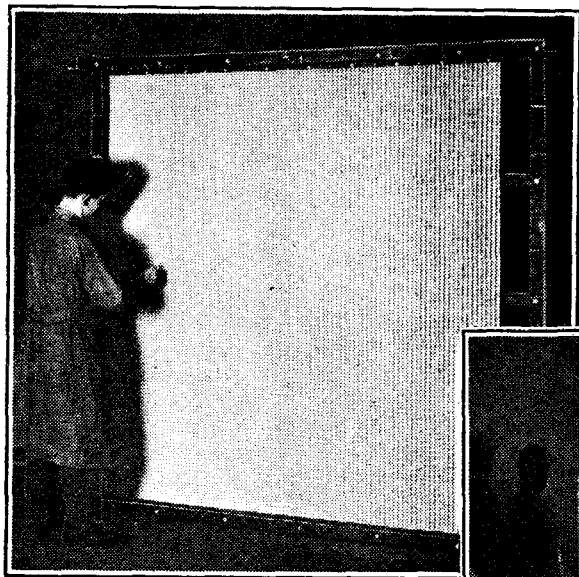

Large Telefunken - Karolus television screen with 10,000 lamp bulbs. Inset: actual photograph of a projected image.

valves fitted with bases made of ordinary bakelite. English manufacturers are saving money by avoiding such practices, but they might take rather more care in reducing dielectric loss and providing better insulation for humid conditions, especially for receivers likely to be exported to the tropics.

Thanks to the demand for high-power amplifiers for political purposes, apparatus of this kind was more in evidence at Berlin than in London. German amplifiers up to about 20 watts are of the Class "A" type, while those above employ modified "quiescent" systems. Methods of suppressing harmonic distortion appear to be more widely used. Perhaps the most progressive amplifier seen at Berlin was a Philips model, which automatically changes itself over from Class "A" to Class "B" when a given signal strength is exceeded.

Thus it seems to me that Berlin is leading in the field of amplification develop-

The German valve manufacturing programme is standardised; 2-volt battery series, 4-volt AC series, 13-volt universal series and 6.3- and 13-volt car radio. In each of these series we have an octode frequency changer, variable-mu and ordinary HF pentode, hexode, diode, triode, double-diode-triode and one or two output pentodes. Each type is, as far as possible, of the same characteristics in all series, with the same base fitting and the same external dimensions.

Speakers and Components

There seems to be little to choose between the loud speakers of the two countries; although high-note tweeters are better developed and much cheaper in England the "Nawi-membran" seems to be exclusive to us; this is a novel type of cone diaphragm designed scientifically for minimum harmonic distortion.

With regard to components, iron-cored

Listeners' C



HUGHIE GREEN AND HIS GANG have a place all their own in the B.B.C. programmes. Another of their half-hours, devoted to "Music, Songs and Laughs," will be given on the National wavelengths at 8 p.m. on Thursday next, September 19th.

BACK AT SAVOY HILL

THE retrospectiveness of some recent broadcast programmes has been almost mawkish in its sentimentality, but I can promise that this will not be the mood of "Who Remembers?" Miriam Ferris's reminiscent programme of the Savoy Hill days, to be broadcast this evening at 9.10 on the Regional wavelengths.

Originally the programme was to have been actually performed in the old building at Savoy Hill, but unfortunately this is already at the mercy of the pick and excavator.

Only artists who broadcast as far back as 1924 will take part, and they will include Tommy Handley, Alma Vane, Jean Allistone, John Rorke, and Harry Pepper.

PROMISING "PROMS"

THE highlight of next week's "Proms" will be the Russian Concert on Thursday, September 19th, which will mainly consist of works by contemporary composers.

The Monday Wagner programme includes such favourites as "The Ride of the Valkyries" and "The Flying Dutchman" Overture. Sir Hamilton Harty will conduct his own Violin Concerto in D on Tuesday, when Paul Beard,

leader of the London Philharmonic Orchestra, will be the soloist. Those two famous brothers, Adolf and Hermann Busch, are soloists in Brahms' Concerto in A Minor for violin, violincello and orchestra on Wednesday.

SONGS FROM THE SHOWS

MONDAY and Tuesday will see the revival of that very popular feature, "Songs from the Shows." John Watt, the deviser and compère, is making a slight change. In the previous series a particular music-hall was featured in each programme, but in the new series Mr. Watt will contrast the songs of different composers. Lionel Monckton and George Gershwin are the composers whose songs will be dealt with on Monday (Reg., 8) and Tuesday (Nat., 7.50).

The B.B.C. Variety Orchestra and Chorus will be conducted by Stanford Robinson, and Harry S. Pepper and Doris Arnold will be at the pianos.

HUGHIE GREEN'S HOLIDAY

THE average juvenile is capable of entertaining an adult for perhaps one minute, or slightly less, and it is a real tribute to the versatility and showmanship of Hughie Green

that he and his "Gang" really warrant the half-hour allocated to them in the National programme at 8 on Thursday next, September 19th.

Hughie Green's own orchestra will be conducted by Alan Parsons.

This will be Hughie's last appearance at a B.B.C. microphone for some time, for he sails for America on the "Empress of Britain" on September 21st for a holiday tour which will range from Saskatchewan to San Francisco and Hollywood. He hopes to return in December "full of new ideas."

A PRE-WAR THRILLER

A REAL thriller with a *denouement* which does not disappoint figures in the Regional programme on Wednesday next (8.20). This is Bayard Veiller's melodrama, "Within the Law," first staged in 1913 at the Haymarket Theatre, over four hundred performances being given. It was successfully revived in 1920.

The plot concerns an intelligent girl forced by circumstances to work behind the counter in a large London shop. She becomes the leader of a gang of crooks whose blackmailing activities are

always just "within the law." Her plot to trap her former employer's son into marriage is successful, and in a magnificent scene she discloses her identity and defies the father to get rid of her.

Howard Rose will produce the broadcast version, and a large cast will include Joyce Kennedy as Margaret Taylor, the heroine; Ralph Truman as Edward Gilder, the store proprietor, and Hubert Gregg as Dick Gilder, his son. The *dramatis personæ* winds up with a fine collection of policemen, burglars, etc., so we have all the ingredients for a bright evening.

AND NOW . . . SCARLATTI

THE Fates may have had a kindly eye on the future B.B.C. when they chose the year 1685 for the birth of both Bach and Handel. As a result 1935 is proving an easy one for the Corporation's music department. Already the Bach and Handel 250th anniversary celebrations have yielded a cornucopia of programme material, and now that even this rich store is beginning to run dry, there is the 250th birthday of Domenico Scarlatti—a lesser light beside these others in much the same way that Ben Jonson and Marlowe suffered by proximity to Shakespeare.

That Domenico was actually a front-rank musician the B.B.C. is now going to prove in the "Foundations of Music" series. The celebrations, which begin next Mon-

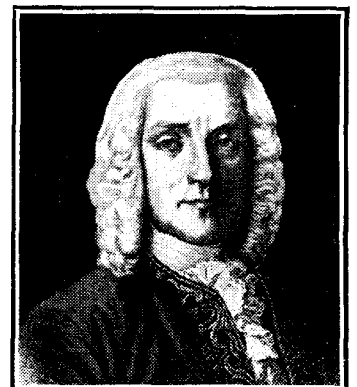

DOMENICO SCARLATTI, the contemporary of Bach and Handel, was born in 1685. The 250th anniversary of his birth is being celebrated in the "Foundations of Music" series.

Guide for the Week

Outstanding Broadcasts at Home and Abroad

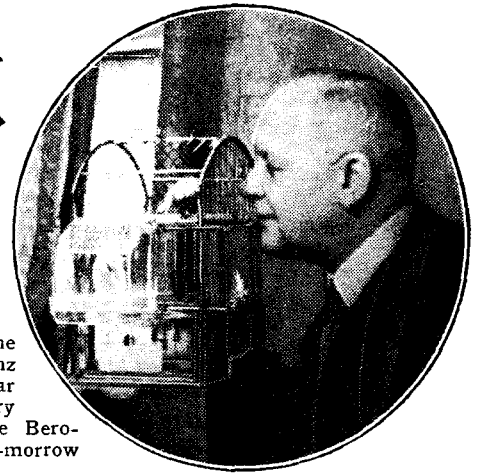

An intimate picture of the famous composer, Franz Lehár, whose ever-popular operetta, "The Merry Widow," figures in the Beromünster programme to-morrow (Saturday) at 8.

HIGHLIGHTS OF THE WEEK

FRIDAY, SEPTEMBER 13th.
Nat., 8, Beethoven Promenade Concert. 10, Gershon Parkington Quintet. 11.15, Harry Roy and his Band.

Reg., 8, "Friday the Thirteenth." 9.10, "Who Remembers?"

Abroad.
Rome, 8.40, Orchestral Concert; "Music Inspired by Spain."

SATURDAY, SEPTEMBER 14th.
Nat., Alfredo and his Gypsy Orchestra. ¶Variety. ¶B.B.C. Theatre Orchestra.

Reg., 8, Promenade Concert. ¶The B.B.C. Singers. ¶B.B.C. Dance Orchestra.

Abroad.
Vienna, 7.15, 3-Act Operetta: "Cagliostro in Wien." (Johann Strauss).

SUNDAY, SEPTEMBER 15th.
Nat., Alfredo Campoli and his Orchestra. ¶Recital of Madrigals by B.B.C. Singers. ¶New Georgian Trio.

Reg., B.B.C. Military Band. ¶Medvedeff's Balalaika Orchestra. ¶Boyd Neel String Orchestra.

Abroad.
Berlin (Funkstunde), 8, German Opera Music by the Augmented station orchestra.

MONDAY, SEPTEMBER 16th.
Nat., Wagner Promenade Concert. ¶B.B.C. Theatre Orchestra.

Reg., Troise and his Mandoliers. 8, "Songs from the Shows." 9, "Pariah," a play by Strindberg.

Abroad.
Brussels No. 2, Brussels Symphony Orchestra at the International Exhibition.

TUESDAY, SEPTEMBER 17th.
Nat., 7.50, "Songs from the Shows." ¶Programme of Gramophone Records: "From Cadiz to Pyrenees."

Reg., Promenade Concert. 9.40, Les Allen and his Canadian Bachelors.

Abroad.
Leipzig, 8.10, Variety: "Radio Rockets from the Elbe."

WEDNESDAY, SEPTEMBER 18th.
Nat., Part Songs by B.B.C. Singers. ¶Brahms Promenade Concert. ¶Gershon Parkington Quintet.

Reg., 7.20, "A Variety Recipe," by Ernest Longstaffe. 8.20, "Within the Law," a melodrama.

Abroad.
All Scandinavian Stations, 8, Danish and Czech Contemporary Music.

THURSDAY, SEPTEMBER 19th.
Nat., Hughie Green and his Gang. ¶Norman Long. ¶B.B.C. Theatre Orchestra. ¶Leslie Bridgewater Harp Quintet.

Reg., Oscar Rubin and his Romany Band. ¶Russian Promenade Concert.

Abroad.
Deutschlandsender, 8.30, Berlin Philharmonic Orchestra, conducted by Hans Pfitzner.

day, will be notable for a performance of Scarlatti's opera, "Narciso," which was first produced in London on May 20th, 1720, and a wealth of harpsichord music, much of it in MS. No doubt room will be found for the celebrated "Cat Fugue," based on a theme provided by Scarlatti's domestic pet as it scampered across the keyboard.

THE "ALL BLACKS"

THE all-conquering "All Blacks," New Zealand's Rugby Football Club, play the opening match of their tour at Birmingham on Thursday next, September 19th. W. W. Wakefield will broadcast a description of the game between New Zealand and the North Midlands.



HARRY ROY comes to the microphone to-night with late dance music until 12. He is seen here with his vocalists, Bill Currie and Ivor Moreton.

FROM A MOTOR SHIP

A KALUNDBORG "O.B." from the Polish motor-ship, "Pilsudski," on her maiden run will be given from the harbour at Copenhagen at 2 p.m. on Tuesday next. The transmission lasts till 3 p.m., and will include a concert by the ship's orchestra.

Another maritime "O.B." comes from Kalundborg on Thursday, when an announcer in a motor boat will follow the Danish herring fleet in order to give a sound picture and running commentary.

OPERA

OPERA lovers will have no cause to complain during the next seven days, for the Continental stations offer a wide choice. Bizet's ever-popular "Carmen" comes from Brussels No. 1 to-night at 10.25; and for those listeners who can enjoy an opera on gramophone records there is Madrid's broadcast of Massenet's "Werther" at 9.30.

Old favourites and new works are featured to-morrow. At 6.15 excerpts from Mozart's "Il Seraglio" figure in the

to be broadcast to-morrow by Hamburg (9 p.m.) and Prague (6.20) respectively.

OPERETTAS

FOUR choice broadcasts for the lover of operettas are promised for to-morrow evening. At 7.15 Vienna offers Johann Strauss' three-act "Cagliostro in Wien" by the Vienna Symphony Orchestra, conducted by Holzer. At 8 p.m. one must choose between Lehár's "The Merry Widow" from Beromünster, and Messenger's "Veronique" from Brussels No. 1. Then, at 9, Toulouse gives one of its popular concert versions, the operetta being "Les cloches de Corneville," by Planquette.

A NAZI FESTIVAL

THE particular kind of imagination which has been fostered by a decade of broadcasting helps many people to appreciate a foreign "O.B." even when they are ignorant of the language. To such listeners Munich offers a grand attraction throughout this week-end in the form of moments with the Reich Party Congress at Nürnberg. For example, at 5 p.m. this evening there is a march past of Party Officials at the Aerodrome, and at 8 p.m. the Proceedings at the Women's Congress in the Festhalle. To-morrow morning at 10 there is a Hitler Youth Manifestation at the Stadium. On Sunday morning the Storm Troops will be heard parading at 8. Three hours later the microphone will be present during their march past before Herr Hitler. On Monday at 3.30 p.m. the Defence Forces' display will be heard. The grand *finale* comes at 9.30 p.m. in the shape of a Tattoo.

THE AUDITOR.

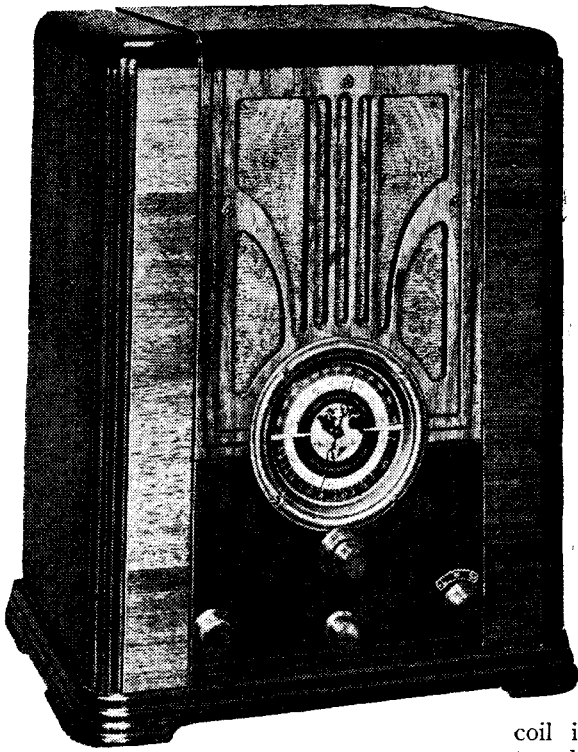

Andrea MODEL 1-A-5

Clear-cut Reproduction and High Selectivity

FEATURES.—Type.—Table-model AC superheterodyne for short, medium and long waves. **Circuit.**—Heptode frequency-changer — var.mu pentode IF amplifier — double-diode-pentode second detector — pentode output valve. Full-wave rectifier. **Controls.**—(1) Tuning (two speeds). (2) Volume and on-off switch. (3) Wave-range. (4) Tone. **Price.**—13½ guineas. **Agents.**—Allwave Radio Distribution, 32, Queen Street, Manchester.

IN common with many other American sets of the table-model type, this receiver is of remarkably neat and compact design. That is not to say that it bears any relationship to the so-called "midget" types, for it is designed to work with a full-sized outdoor aerial, and the specification of the chassis has not been unduly scaled down in order to achieve compactness.

There are four valves in the circuit operating as frequency-changer, IF amplifier, second detector, and output valve respectively. An interesting form of aerial coupling has been adopted which is designed to give even amplification over the waveband. Connected on the earth side of the primary tuned circuit in the band-pass filter is a fixed condenser which is virtually in series with the tuning condenser as far as the closed circuit is concerned. A capacity potentiometer is thus formed, and as the tuning capacity in-

creases so does the input from the aerial. The usual falling-off at the top of each waveband is thus adequately compensated.

Band-pass tuning is used only on the medium- and long-wave bands, and a separate coupling coil in the aerial lead feeds the single tuned circuit on short waves. A circuit tuned to the intermediate frequency of 470 kc/s is also included in series with the aerial, and prevents Morse interference from reaching the IF stage.

Circuit Details

The frequency-changer is a heptode and the IF amplifier a variable-mu pentode. Rectification is effected by a double-diode-pentode in which the diodes are connected together to form a single electrode. HF filtering, apart from the usual by-pass condenser across the diode load, is left to the decoupling resistances and condensers in the AVC leads. The LF component is fed to the working grid of the pentode portion of the valve through a coupling condenser and high-resistance potentiometer, the latter functioning also as the volume control for the gramophone pick-up.

Resistance-capacity coupling is also used

between the second detector stage and the output valve, and the tone control takes the form of a condenser connected to the slider of a potentiometer in the grid circuit of the latter valve.

The most noticeable feature of the performance is unquestionably the high sensitivity, which is outstanding on the medium and long waves. Furthermore, the sensitivity is equally good at the extremities of wavebands, and the usually uninteresting patch above 450 metres on the medium waveband is productive of several interesting programmes at full strength.

As is only to be expected, in view of the absence of an HF stage there are repeat points separated by twice the intermediate frequency for every station received on the short-wave band, but this is sometimes an advantage when Morse interference is experienced at one of the settings. The morning programme from Schenectady (19.86 metres) was well received, and there can be no doubt that the short-wave enthusiast will be assured of a good "bag" in this wave-range.

No trace of any second-channel or oscillator harmonic whistles could be found on the medium- and long-wave bands.

As regards selectivity, two channels were lost on either side of the London

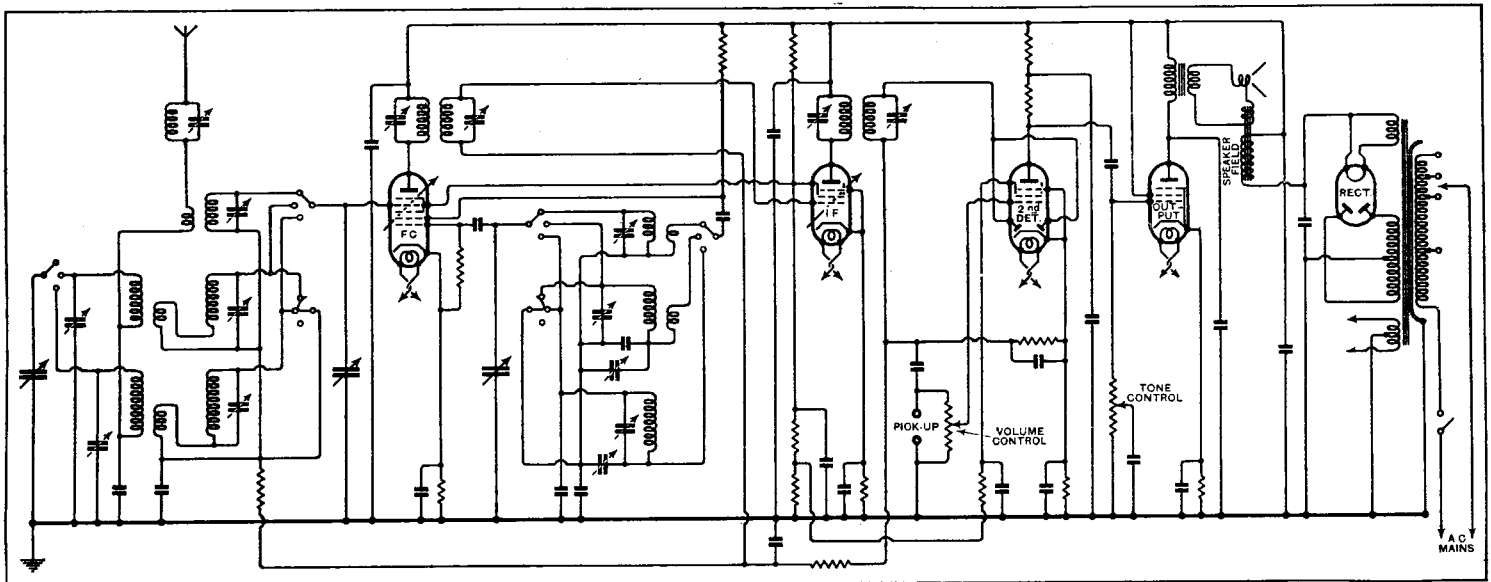

Complete circuit diagram. Band-pass tuning is employed on medium and long waves and a single tuned circuit on short waves.

Andrea Model 1-A-5—

Regional station when working the set in Central London, and one channel on each side of the London National transmitter. On long waves Radio Paris and Droitwich could be comfortably separated, but there was hardly enough clearance between these two stations to permit the satisfactory reception of the Deutschlandsender.

The reproduction is notable for its clear-cut quality, and the high-note response is decidedly above the average. At full volume, in fact, the top is inclined to acquire a rather penetrating edge unless it is tamed a little by the tone control. The 6in. diameter diaphragm cannot be expected to give a very full bass response, and the makers have wisely resisted the temptation to produce an artificial bass by resonance.

Random Radiations

By "DIALLIST"

The Knob Question

A CAREFUL examination of the new season's sets shows that there is a considerable diversity of opinion amongst cabinet designers or whoever it is that is responsible for the selection of the knobs which decorate their panels. Time was when wireless knobs were invariably round. Now they may be triangles, squares, pentagons or hexagons. The shape does not matter a whole lot for knobs that one is not constantly twiddling, such as those of the wave-change switch and the volume control; but, in my humble view, the form and size of the knob which controls the

If anybody presented me with a set furnished with queerly shaped or silly little things about the size of shillings the first thing I should do would be to consign the lot to the waste-paper basket and to fit another set of good, honest, round knobs of decent size.

All For Comfort

My feeling is that many a manufacturer would do well to attach less importance to striking appearance and more to the comfort of the person who has to operate their sets. Take the case of wave-change switches. Some of these work so stiffly that it is quite a painful business to operate them by means of the small knobby knobs with which they are provided. The same remarks apply to "on and off" switches. Matters are made a good deal worse if the knobs have their largest diameter close against the panel and then taper off in the manner of sugar loaves. Should they be stiff to turn you cannot operate them with the tips of the first and second fingers and thumb, but must take them, so to speak, by the roots, applying the first joint of the thumb and the second of the first finger. This movement repeated a number of times, particularly with a knob that is all protruding angles, causes you to call down anything but blessings on the head of the unknown individual who chose it because he thought it looked smart and paid no heed to your comfort. If the choice is between pretty knobs and useful ones I'm a thorough-paced utilitarian. Beauty is proverbially skin-deep—but so are the nerves of one's sorely tried fingers.



The 90-day Guarantee

THOUGH one or two firms are still guaranteeing their receiving sets for 12 months, the great majority of manufacturers have now adopted a standardised guarantee for a period of 90 days after purchase. It's a big step forward that there is to be something like a universal guarantee of a straightforward kind, for in the past some guarantees have been neither comprehensive nor altogether comprehensible. I cannot feel, though, that 90 days is sufficient. By this time the wireless set should be as little of a box of tricks and as much a piece of domestic apparatus as the vacuum cleaner or electric iron. The user has the right to expect from it the same reliability as is shown by such things or by the starting and lighting apparatus of his car. It is not unreasonable, therefore, for him to hold that the set-maker should have rather more confidence in his receivers than seems to be implied by a mere 3-months' guarantee. However, now that the ball has been set rolling I shall be surprised if we don't eventually have at least a 6-months' guarantee with good-quality receiving sets.



Cabinet Work

WHETHER you were or were not able to attend the Wireless Exhibition you must by now have seen a good deal of the new season's receiving sets in the shop windows. One thing that can't fail to strike

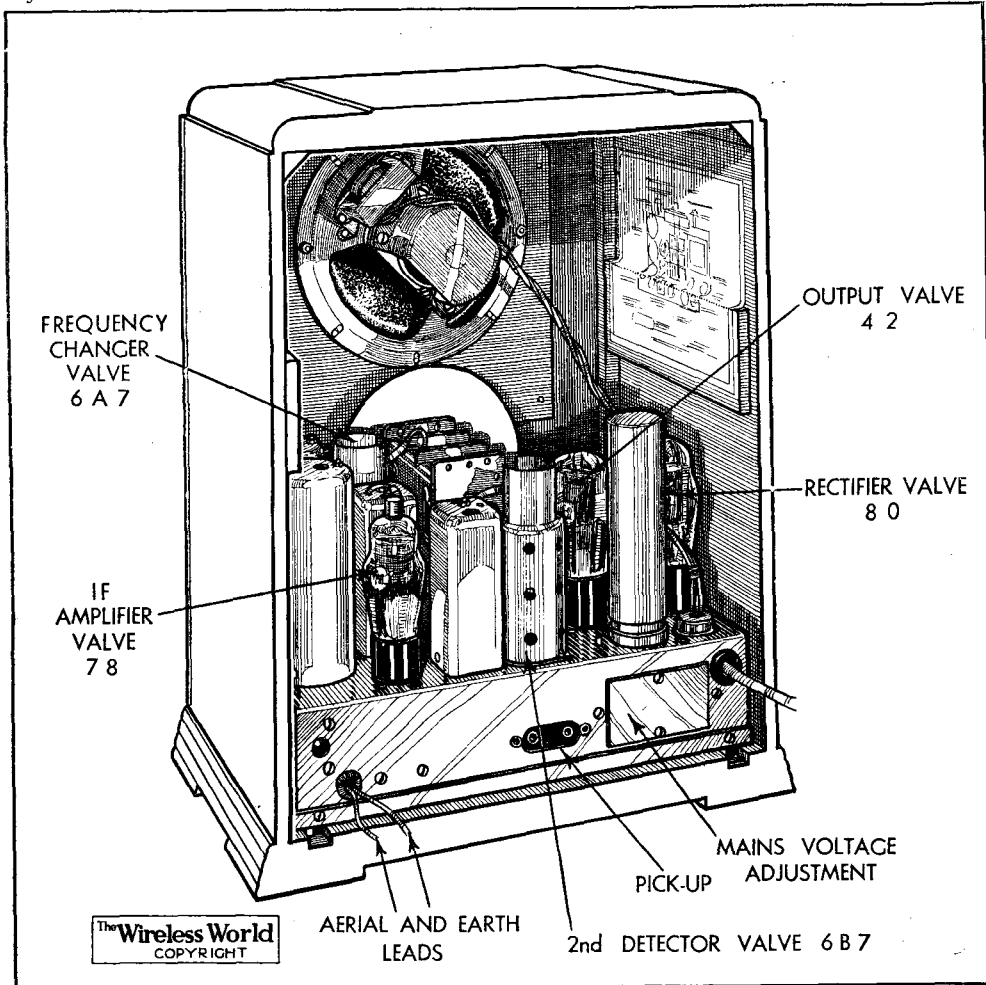

General view of interior. Note the very complete shielding of the frequency-changer and second detector valves.

The clock-face tuning dial has a double-ended pointer, the top half of the dial being occupied by the medium- and long-wave scales calibrated in metres, and the bottom half by the 16.5 to 52-metre band calibrated both in metres and kilocycles. The wave-range switch automatically illuminates the appropriate half of the dial.

An unusual feature is the provision of flexible leads instead of terminals or sockets for the aerial and earth connections. In other respects the chassis follows normal practice, and is soundly made. The cabinet work, too, is notable for its solid construction and the excellence of the finish.

tuning condenser does have a big effect upon the ease and comfort with which the set can be operated. To me it seems that tuning knobs should most certainly be circular. Those of hexagonal shape are not so bad, though I don't find them quite so convenient to use for fine tuning as round ones with milled edges. Also, I want to register here and now my detestation of small tuning knobs of any kind. There are two things against them: the first is that with them hair's-breadth tuning becomes most difficult even when there is a reasonably good slow-motion drive; the second is that if you are spending half an hour or so in searching for Continental or American stations your hand becomes unpleasantly cramped.

Random Radiations—

you is the particular attention that manufacturers have paid this year to cabinet work. So far as I know only two materials have been used hitherto for cabinets—wood and bakelite—though “trimmings” of brass, copper, chromium and other metals have been fairly widely employed. Bakelite lends itself readily to the design of cabinets. It is not an expensive material; it can be produced in a large variety of colours; and once you have put down a very costly moulding plant highly finished bakelite cabinets can be turned out with the rapidity called for by modern mass-production systems.

I personally am a great admirer of wood, which seems somehow to be the proper raw material with which to produce any article of furniture intended to be both useful and a joy to the eye at the same time. At one time oak, walnut and mahogany were almost the only woods employed for wireless cabinets—though I have seen wonderful results produced by treating deal and other soft woods by special processes. To-day the cabinet-maker goes much farther afield, pressing ebony, maple, teak and other lovely woods into service.

Still Something Wanting

Yet I can't help feeling that we have still a long way to go in the matter of wireless cabinet design. As in so many other ways, the histories of the wireless set and the motor car have run very much on parallel lines. The first cars, aptly described as horseless carriages, were little more than phaetons, or wagonettes, or broughams minus shafts or poles and plus engines and steering gear. It took years and years to break away from the tradition that a car body must be designed on lines similar to those of a horse-drawn vehicle. It is, in fact, only within the past few seasons that really good-looking cars have made their appearance. If you doubt this statement halt for a few minutes at the side of any main road and watch the cars that go by. You will agree that those of a few years ago are definitely not things of beauty.

So with the wireless cabinet. Early sets were housed in rectangular cabinets of box-

like form. Though many praiseworthy attempts have been made to break away, the majority of wireless cabinets to-day are still boxes, and, though the best of them are beautiful, I think that we shall eventually cast off the fetters of the past.

Two Ideas

Here are two ideas that occur to me as worthy of the cabinet-designer's art. In the small houses of to-day there is great need of space-saving articles of furniture. I don't remember ever having seen a receiving set cabinet of the corner cupboard type, though I am sure that this would be widely welcomed. The cabinet could be designed either in console form to stand on the floor or it might be made to hang on the walls. I quite realise that a special chassis of triangular form would be needed, but this presents no great difficulty.

My other suggestion is that designers might well examine those miniature bureau writing tables which fetch such high prices in antique furniture shops. Their lines are charming and would lend themselves admirably to receiver cabinet design.

Is the Crystal Set Dead ?

THE other day, in the course of an interesting discussion with the Editor on crystal sets (Yes, *crystal* sets!), I ventured to suggest that there was still a pretty big demand for this type of receiver, however much of a museum piece it might seem at first sight. I can't help thinking that a crystal set designed on really up-to-date lines would find a place in the homes of many readers—it's so useful as a standby in case the valve set goes on strike.

I do know that quite a few firms do a steady business in crystal receivers whilst most wireless shops seem to stock crystal detectors of the perikon type and to have a fairly ready sale for them. We have no means of knowing just what the number of crystal sets is in this country since no declaration of the kind of receiver that is to be used is required when the ten shilling broadcast licence is taken out. In France, where the crystal user pays a smaller licence fee than the valve man, the figures have been worked out. Crystal sets in that

country number more than 60,000. The proportion of crystal sets to valve sets is probably very much the same in both countries, and since licensed listeners in Great Britain outnumber those in France by more than three to one I should be very much surprised if our own total of crystal sets is much under 200,000.

Modern Possibilities

When you come to think of it very little attention has been paid to the crystal set by designers since the days when tuning coils were either huge solenoids with sliding contacts or plug-in “honeycombs.” The performance of a crystal set depends mainly upon the efficiency or otherwise of its inductances, and in the matter of inductances we have advanced a very long way in recent years. In the early valve sets it was not nearly such an important matter if the coils were not particularly good. There was no need for very high selectivity when stations were comparatively few and far between, and much of the losses on swinging coils could be made good by the roundabouts of reaction. The crystal set cannot call in reaction to its aid; hence this type of set is particularly sensitive to the quality of its coils. What it seems to require to do itself full justice is a set of coils of low resistance but high inductance value. To such requirements the modern iron cored coil might lend itself admirably; certainly it opens an interesting field for experiment. Unfortunately most of the iron cored coils available in ready-made form are unsuitable since they are designed purely for use with valves. For the perfect crystal set coils of special design would be needed.

In many other ways modern scientific knowledge could be applied to crystal-set design, and with the high powered broadcasting services now in operation in almost every civilised country quite remarkable reception might be possible. Readers' views on the subject of crystal sets would be welcome.

Co-axial Cables

THE Federal Communications Commission of the United States has authorised, under certain conditions, the laying of a special cable of the co-axial type between Philadelphia and New York by two of the big telephone companies. This cable can handle undistorted a frequency band of 1,000,000 cycles, and the chief purpose of those who are to install it is to use it for television transmissions. The Commission, however, has decided that it must be open for multiple telephone and telegraph working as well, and that all concerns interested in television transmissions shall have the use of it.

If the cable proves successful after a period of experimental work it may solve one of the biggest problems in television, both in the United States and in other countries. It is estimated that at least twenty stations will be needed to cover the more thickly populated parts of our own country, and to provide a similar service in the United States the number would run into three figures. By the use of co-axial cable numbers of stations can be linked so as to radiate the programmes from a central studio. Our own G.P.O. is to lay a special high-frequency line between London and Birmingham in the new year, and in Germany one is already in operation between the Berlin television transmitting station and a relay in the Brocken mountains.

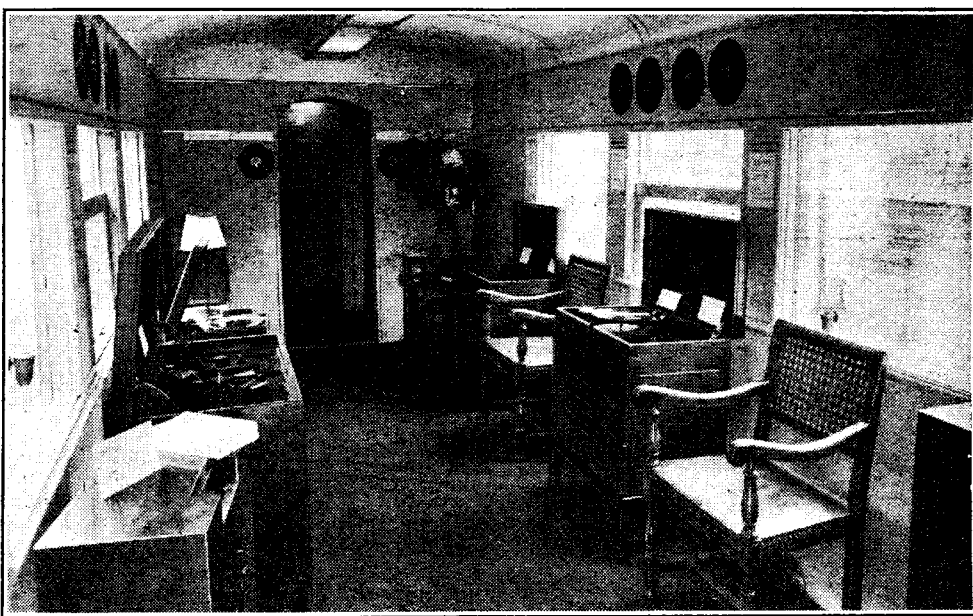

RADIO EXHIBITION ON WHEELS. Seven sound-proof demonstration cabinets are contained in this Radio Train, which Messrs. Alfred Imhof, Ltd., are taking round London and the suburbs. Anti-static aerials are fitted on the roof, and prospective customers are able to test the respective merits of the leading makes of radio receiver.

Broadcast Brevities

By Our Special Correspondent

B.B.C. Relay from Egypt

SOMETHING quite new in the annals of British broadcasting is promised for October 6th, when the B.B.C. will broadcast a unique relay from Cairo with the co-operation of the Egyptian State Broadcasting Service.

The first part of the broadcast will comprise a recital from the Koran by Mohammed Rifaat, followed by a performance by Mustapha Rida Bey and his Oriental Takht (orchestra), the strange instruments of which will be announced and described separately. Ancient Mizmar and Tabl ballads will be played on reeds. The second part of the programme will consist of a commentary superimposed upon the sounds from one of Cairo's busiest streets.

Concluding this unusual broadcast will be a pianoforte recital of oriental music by Midhat Assem and a recital by Umm Kulthum, who has been described as the "Melba of the Orient."

Busy Days at Tatsfield

MR. A. H. V. GRIFFITHS, the engineer in charge at Tatsfield, has a heavy responsibility in handling the "Five Hours Back" series of broadcasts, which is being resumed on October 5th.

Although these transatlantic broadcasts are ostensibly extracted from the ordinary programmes of the National Broadcasting Company of America, it is no secret that the N.B.C. prepares these half-hour sessions specially for the benefit of British listeners.

The standard of talent is higher than would be normally available at 12.30 midday in New York and, moreover, there is a refreshing absence of advertising "blurbs."

No Beam Stand-by

So Mr. Griffiths, rejecting all suggestions that the Post Office beam should be used as a stand-by, relies on his new aerials and collection of superhets. to pick up the transmissions from Schenectady.

Reception of the previous series was fairly good, but recent improvements at Tatsfield may be expected to produce even better results.

New Interval Signals

BAGPIPES, I understand, are to be chosen as a characteristic interval signal for the

Scottish Region. The North Region has been the first to break away from the thralldom of Bow Bells (or, rather, a badly worn record of Bow Bells), and has produced a special recording blending York Minster bells with phrases from the North Country song, "The Oak and the Ash and the Bonny Ivy Tree," played on a celeste.

Fortunately, Scotland's bagpipes will not blend with anything else on earth.

Women Announcers

A BRITISH woman is permitted to perform in a broadcast studio without exciting much more comment than that occasioned by a century in county cricket, but let her announce the next item in the programme and the heart of the nation misses a beat.

Two women have been announcing during the holiday season, one in the Scottish



MR. JOHN F. ROYAL, Vice-president of the American National Broadcasting Company, has been touring Europe investigating the different broadcasting organisations. He is here seen on left in conversation with Dr. Kurt von Boeckmann, director of the German short wave station.

Regional programmes and another at West Regional. Both ladies are associated with their Regional Children's Hours.

Strange Voices

In the old days announcements by strange voices did not attract attention; in fact, the job of introducing successive items was often delegated to any

responsible male who happened to be available.

On occasion even Sir John Reith and Sir Charles Carpendale have acted as announcers. It is only because the programmes are now conducted on such rigid lines that a change of voice flutters the doves and makes listeners wonder if the set is still functioning properly.

Winter Variety Plans

THE "Saturday Magazines" are among the most attractive of the features promised by the Variety Department for our delectation during the winter months. These are to last forty-five minutes each and, as their title suggests, will consist of interesting scraps, not forgetting "In Town To-night," which will be incorporated in each magazine.

A New Feature

Brian Michie has invented a feature, "Variety of Music," which will consist of high-speed musical shows. Informal parties of the type organised by Stanelli are to be more frequent; indeed, there will be so many additions to the lighter side of the B.B.C. programmes that the "Music Halls" will be restricted to one a month, each show lasting ninety minutes, and having an all-star bill.

Five Commandments

I have been privileged to inspect the Five Commandments which have governed the Variety Department's plans. Dance music sessions are to be limited to ninety-minute periods; there are to be no regular periods earmarked for variety; there are to be fewer studio audiences; there are to be new experiments in variety presentation and, perhaps most important of all, more opportunities to incorporate topical and last-minute items.

Fewer Studio Audiences

"Music Hall" audiences will not, as has been suggested, be smaller, but, with fewer "Music Hall" broadcasts, there will be less opportunity for the general public to see their favourites at the microphone. Thus the waiting list for seats in St. George's Hall will tend to grow even longer, and it seems more than likely that those who apply from now onwards may have their aspirations satisfied by television before the long-awaited tickets arrive.

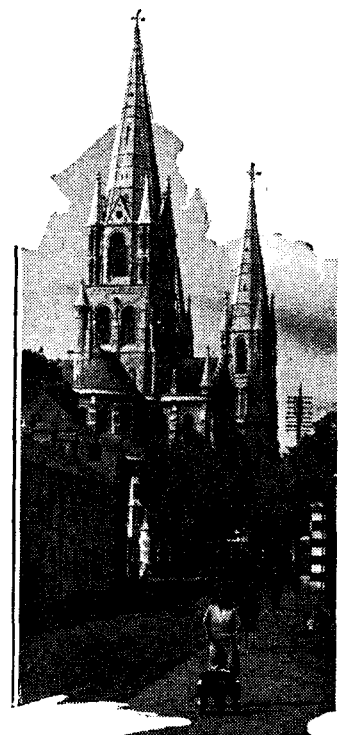

ST. FINN BARRE'S CATHEDRAL, CORK, from which organ recitals are frequently relayed by Athlone.

A Shock

What a shock awaits the B.B.C. when the first letter is received announcing that "Mr. Blank regrets that he is unable to use the enclosed complimentary ticket for 'Music Hall,' having arranged to witness same by television."

Their Native Heath

IF Sir Stephen Tallents is not the unseen influence behind the forthcoming talks series, "Places Revisited," then the Talks Branch has acted with prophetic instinct, for surely nothing could popularise the B.B.C. more than this introduction of truly local colour.

Early Memories

Celebrities well known for their descriptive powers are to revisit towns or localities with which they are connected or where they have spent some time. Early memories of and present changes in these favoured places will be described to listeners. Among the speakers will be A. G. Macdonell, author of "England, Their England"; James Agate, drama critic; James Bone, literary editor of the *Manchester Guardian*; and Robert Lynd, essayist and literary editor of the *News-Chronicle*.

The first talk of the series is on September 29th.

A. J. Alan

IN the not-far-distant future I hope to make an interesting announcement concerning the famous raconteur.

UNBIASED

Nearly Deceived

WHEN needing a haircut or shave I invariably journey abroad because, owing to my fortunate lack of linguistic ability, I am thus mercifully prevented from understanding the wretched back-chat of the chin-scraper in attendance.

Being chidden recently by a cantankerous female acquaintance on the rough state of my face, I set out for the particular male beauty parlour which I favour, where, as I have mentioned before, the enterprising proprietor has cunningly hidden earpieces in the head-rest of each execution chair in such a manner that the victim can listen in to broadcasting no matter whether he is being shaved or shampooed.

As I settled myself comfortably into the chair and was gracefully tilted up in order to have my face dolled up, I was astonished to see, projected on to the square patch of ceiling above me, a rather flickering representation of one of the London studios. My astonishment grew when I saw a popular actress enter and commence one of her popular numbers, the sound of which came to me through the earpieces concealed in the head-rest.

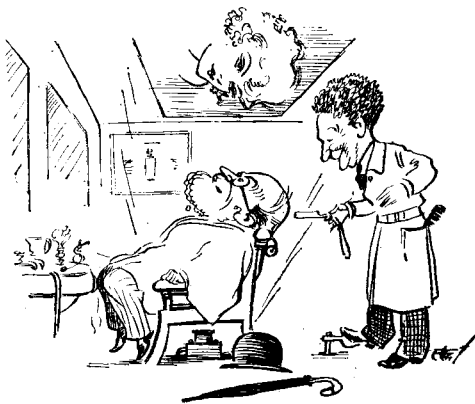

My astonishment grew.

By signs, the barber contrived to make me understand that I was witnessing a television demonstration from London. Informing him with some asperity that I was not such a fool as I looked, I endeavoured to make him understand that the high-definition service from London had not yet commenced and that, in any case, the lips of the singer were completely out of synchrony with the music coming from the earpieces in the head-rest; in fact, it was obvious that she was singing a different song.

The barber was pig-headedly insistent, however, and tempers were rising rapidly on both sides when explanations were offered by a fellow-victim in the next chair who happened to possess a good command of English. It appeared that the enterprising barber, fired by the wild stories

By FREE GRID

published in certain sections of the English Press last February about the imminence of a London television service, had gone to great expense in installing television receiving gear in order to entertain his patrons. The apparatus was installed in a room upstairs, and arrangements were made to project the television picture on to several translucent screens let into the ceiling above each chair.

Unfortunately the B.B.C. had let the barber down badly by not commencing transmissions immediately, and as there did not seem to be any hope of the television service starting up for several months he had hit upon the idea of securing a number of films of various bands and performers in action in the B.B.C. studios. These he threw on to the various screens by means of a small home-cinema projector under each chair, one of which he was industriously turning with his foot at the same time as he shaved me. Apparently this artless deception was all that was needed to throw wool into the eyes of the local yokels, and had it not been for my keen perspicacity, the deception might have worked with me.

I must confess, however, to a feeling of admiration at the enterprise and ingenuity of the whole affair, and only wish that similar signs of exemplary initiative were displayed in our own country.

About Those Records

MANY complaints have reached me lately concerning the excessive scratch associated with the B.B.C.'s transmission of records. This is, of course, solely due to record wear, as the B.B.C.'s thriftiness forbids their renewing the discs until the needle has actually penetrated the record, thus merging one tune into the other on the opposite side. Even then when the two tunes are thus inextricably intermixed the records are used for the broadcasting of jazz and chamber music, in which, of course, cacophony is at a premium. As a matter of fact, I have long been engaged in designing a "progressive" scratch filter for use with broadcast receivers whereby the degree of filtering will gradually increase with the age of the B.B.C.'s records.

But this is beside the point. What I wish to complain about are the signs of wear now beginning to be obvious in the special records which they have had made of the various orchestras "tuning up." I am not so hidebound and narrow-minded that I consider a little innocent deception and double-dealing to be indicative

of moral turpitude, but I do like the thing done artistically. Nothing commends my admiration more than the little delicate touches put in by certain of the more enlightened of the programme staff who first

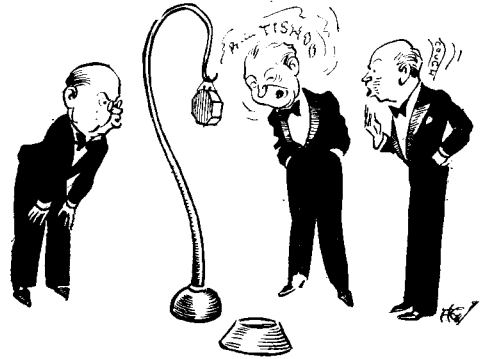

Coughings and feet-shuffling.

introduced this system of linking up the B.B.C.'s unannounced programmes of records by means of these special recordings of the coughings and feet-shuffling of mythical Queen's Hall audiences and of the noises of the band getting ready.

The great saving thus effected in the cost of the hire of concert halls and the fat fees of instrumentalists must draw forth nothing but praise from all but the most puritanical, but the artistry of the thing is spoilt by attempts to effect further petty economies by not renewing these records with sufficient frequency. As a result our admiration may turn to disgust.

More About Balloons

I HAVE received a mass of correspondence as the result of my recent "balloon" revelations (new readers see "W.W." 23/8/35). For the most part they are from indignant correspondents who have wasted their money in trying to win the prize against impossible odds. While I have every sympathy I cannot, as they suggest take up their case. The remedy lies in their own hands.

My most interesting letter, however, comes from a reader who frankly discredits my statement, the reason for his so doing being an extremely naive one. "Nobody," he writes, "would be such a fool as to risk detection and possible confiscation of his transmitting licence by doing as you state. I myself, although possessing a transmitting licence, would not think of putting my transmitter to such base and risky uses as you suggest. My practice is invariably to take up my stance in a lonely field to windward of the place where the balloons are to be released and to shoot them down with an air gun as they appear. This having been done, it is, of course, an easy matter for me to take my own previously purchased balloon and put it in the nearest pillar box in the sure and certain knowledge that there will be nothing to beat it. By this procedure I save myself a great deal of trouble, avoid all risk of detection, and do not have to share my prize with a second party."

New Apparatus Reviewed

Recent Products of the Manufacturers

BULLDOG GIANT POWER BATTERY

MADE by Britannia Batteries, Ltd., Red-ditch, Worcestershire, this recently introduced dry battery is described as a sal-ammoniac type and is designed for heavy-duty work. The highest economical discharge current is 20 mA., but it is stated to be able to deal with demands up to 35 mA. Our tests were commenced at a discharge of 18 mA. using a suitable load resistance, the battery being discharged intermittently for periods of four hours with like intervals for rest and recuperation.

The discharge curve shows only the actual working time, as the recuperation periods have been omitted for convenience.

It is assumed that the end of the battery's useful life is when its voltage falls to half the nominal value, this corresponding to 0.75 volt per cell. There being 80 cells in this 120-volt model, the end-point is placed at 60 volts on the curve which gives a working life of 600 hours. For the last half of this period the voltage remained comparatively steady at between 65 and 70 volts, but when the final decline set in the fall was much more rapid, the battery being

The price of this Bulldog Giant Power 120-volt battery is 16s., and it is tapped through-out at 12-volt intervals.

CLIX SW VALVEHOLDER

AMONG the new range of valveholders introduced by Lectro Linx, Ltd., 79a, Rochester Row, London, S.W.1, is a base-board mounting model designed especially for short-wave use. The plate which carries the sockets is made from a very high grade of Bakelite, and the whole is raised on three ebonite supports each $\frac{3}{4}$ in. long. Despite its skeleton appearance, for the minimum of material is employed, the valveholder is by no means fragile, for it stands up to the stresses of normal use, as we have proved by experiment.

Clix resilient slotted sockets are fitted, and the soldering tags, which are integral with the sockets, extend beyond the edge of the Bakelite plate to facilitate soldering the connections. Between the sockets this supporting plate has semi-circular air slots to lengthen the effective leakage path from socket to socket.

Tested in a short-wave set this new valve-

SOUND SALES 465 KC/S IF TRANSFORMERS

AN intermediate frequency transformer of the variable selectivity type, and designed for 465 kc/s, is one of the latest products of Sound Sales, Ltd., Marlborough

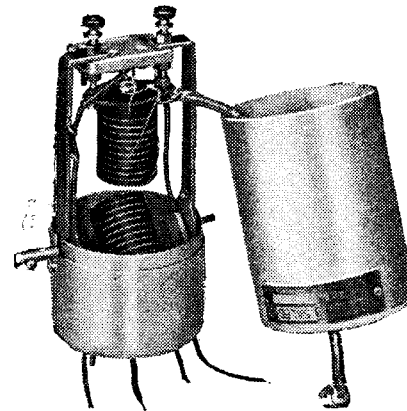

Sound Sales 465 kc/s variable selectivity IF transformer with cover removed and showing the assembly of the coils.

Road, Upper Holloway, London, N.19. It is fitted with iron-cored coils, the winding on both primary and secondary bobbins being divided into ten sections. These are tuned by small mica-dielectric condensers located one at the top and the other at the bottom of the coil assembly.

Discharge curve of the Bulldog Giant Power HT battery.

Britannia Batteries Bulldog Giant Power 120-volt model for heavy duty work.

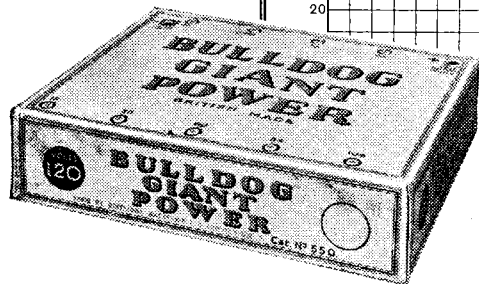
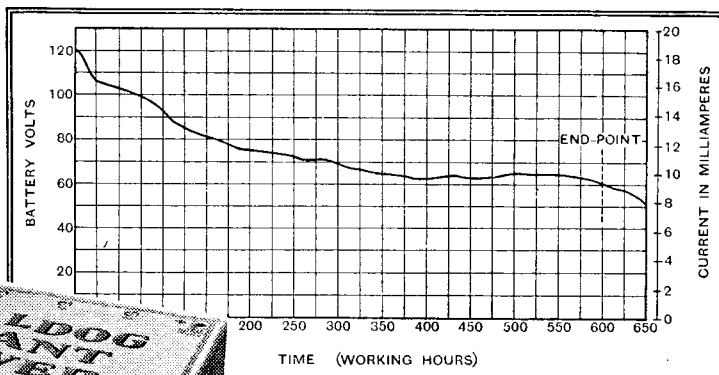

holder was found to be very satisfactory, and so far as could be judged by results it did not introduce any apparent losses. It was fitted, also, in an ultra-short-wave set, and again the performance was exemplary.

Four-, five-, seven- and nine-pin models are available with and without terminals,

practically exhausted after 700 hours discharge.

The total capacity of the battery up to its end point is 528.7 watt hours, each cell provided 6.61 watt hours, a very good performance indeed, since their size is $1\frac{1}{2}$ in. in diameter and $2\frac{1}{4}$ in. high only.

Examination of the battery showed that the work had been fairly evenly distributed throughout, and although the majority of the zinc containers were reasonably intact, the walls were so thin that they collapsed at the slightest pressure. Obviously a well-judged quantity of active material is employed in these batteries.

This model will provide a very economical source of HT power for most battery receivers, more especially if the current demands are not too exacting, though from its performance on test we judge that a reasonably long life can be expected even at maximum discharge.

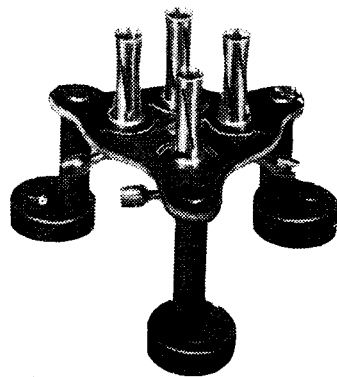

"Leg-supported" new Clix baseboard short-wave valveholder.

the prices of the latter style being: 4-pin 1s. 6d., 5-pin 1s. 7d., 7-pin 1s. 9d., and 9-pin 2s.

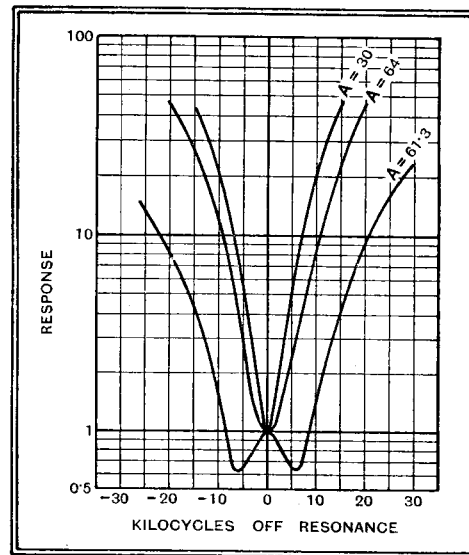

Resonance curves of Sound Sales 465 kc/s variable selectivity IF transformer.

The primary winding has a tapping two-fifths from the low-potential end for the anode connection; this lead is screened and brought out through the top of the case, while all other leads pass through holes in the base.

Variation in the selectivity is effected by rotation of the secondary coil, though stops are fitted to limit its movement, the widest band-width obtainable being approximately 12 kc/s between centres of the peaks. This is adequate for all practical purposes, and no material advantage would be gained by a larger movement. In the most selective position the coupling is so loose that

New Apparatus Reviewed—

the stage amplification falls to about four only.

The response curves reproduced here were taken using the anode tapping joined to a VMP4 valve which preceded the transformer and with the secondary connected to a valve voltmeter. With the optimum coupling a stage gain of 64 was obtained, which is probably about the maximum that can be tolerated with two IF stages in an amplifier of normal design assembled in the customary manner and with the usual precautions to ensure stability.

Sub-optimum coupling gives slightly better selectivity and a lower stage amplification, as shown by the curve marked $A=30$. With couplings tighter than the optimum the familiar two-peak response curve is obtained, the peaks opening out with a well-defined valley between them, until at the limit of the movement allowed a response as shown by $A=61.3$ is obtained.

Small collars are available for joining the spindles of two or more transformers so that they can be operated by a single knob on the control panel.

These IF transformers cost 10s. each.

speaker cone when reproducing low and high notes simultaneously. It is rightly stated that it would be incorrect to base calculations for tone compensation on individual sounds, as weak ones are reduced still further when louder sounds are introduced.

Dual Speakers as a Solution ?

If the louder sound is a bass frequency and this is boosted up, the weaker one, which may be a high audible frequency, can suffer a complete eclipse. In the electro-mechanical action of the moving-coil cone this effect is quite common. I therefore suggest tone compensation as outlined in the article can only be considered in relation to two separate reproducers, one for bass and middle and one for high frequencies, such as a "tweeter." Perhaps this offers a practical solution to the imbrogio?

Then with regard to achieving a level response curve at various settings of a volume control, I have reason to believe that a control in the grid circuit of an LF valve does not provide for straight-line amplification owing to varying resistance paths according to the position of the slider. A "T" resistance arrangement will obviate the undesired effect with a reduction of the available input voltage.

There are several other volume-control arrangements which do not affect the response curve, and these obviate to a great extent the need for boosting of low frequencies, as with grid circuit controls.

I believe a tone control transformer such as the Multitone will nearly perform the same effect as the extra valves shown in Fig. 3 in the article.

"A B C" is certainly ingenious, but I have yet to be convinced that under present broadcasting conditions I would be improving my receiver by introducing it.

Manchester. G. V. COLLE.

Olympia in Retrospect

ANOTHER Radio Show having just closed its doors, it is now probably a suitable time to make some observations regarding various aspects of the show.

The central amplifier seems to have deteriorated very badly. Not only was there a marked absence of the lower frequencies, but what there was of the top seemed to be badly distorted. Also the output seemed to vary in a most erratic sort of way, on occasions the reproduction being almost inaudible, whilst on others it was almost too loud. Is no attempt made to match the amplifier to the load of the numerous speakers, and is any check made on the impedance of the various speakers connected across the lines?

Would it not be possible to revert to the old idea of demonstration rooms? Under the present system it is not only impossible to hear a loud speaker under reasonable conditions, but it is also impossible to try out a set under normal conditions of working. After all, Olympia should surely be not merely a *show* place, but also a place where sets may be tested under working conditions.

The practice of some manufacturers seems to be to prepare special show models, all parts being polished, etc. The actual commercial product is generally anything but polished, and it seems only fair that a replica of the commercial product should be shown, and not a specially produced model.

London, S.E.3.

Letters to the Editor

The Editor does not hold himself responsible for the opinions of his correspondents

High Fidelity

I HAVE read with interest the letters of your correspondents regarding "High Fidelity," but as yet one very important point has not been raised. This is valves. It is my experience that good equipment shows up faults in valves which would pass unnoticed in ordinary receivers. As quality increases the number of valves used, and the size of several of them, the valve replacement bill per year is prohibitive.

"High Fidelity" can mean little to the ordinary listener if his valve replacement bill for the year is to be about half what the average set is sold for.

Wilts. J. S. THOMAS.

Foreign Market for Receivers

IT is very emphatically pronounced by your correspondent, Mr. S. R. C. Allen, of Gibraltar, that the British radio manufacturer is dead to all interest in the overseas market, and I heartily endorse his observations.

His criticism is quite caustic enough to create a shudder in any board-room, but do his excellent and helpful observations reach these temples of commerce, as they should?

It is sad to relate, but none the less true, that the average radio manufacturer is a Little Englander! He sees no farther than our seaside resorts, and those he does not always like, when he finds his set absorbs all the stray mose within miles, and is, therefore, totally inadequate.

But is the position in the overseas market in radio new to commerce? I should say definitely no. And I would instance our great British motor industry, which has only comparatively recently realised that British cars can be made to suit Colonial roads and that it is comparatively easy to sell the product in face of the fiercest American sales activity.

Slow Motion

It amazes one to observe that our large electrical groups, who have radio departments, do little to foster Colonial expansion, even when their other departments prosper in every corner of the world!

I have an intimate knowledge of the British radio manufacturer, having sold his products ever since the year one in radio, and I find him always alive to absorb a proposition, but there it sticks, until one

day he will get a hustle on and out of his hat comes your idea, but he is definitely slow upon the uptake.

When he does set about opening up new markets he is nearly always successful, because nothing, after all, is quite so good as British the world over, but he cannot be rushed or stampeded. Perhaps his conservatism is well rewarded, as, after all, our friends in the U.S.A. have done all the spade-work and he just follows up that and gets all the gold!

I certainly hope that Mr. Allen and other patriotic overseas dealers will not lessen their effort to put a squib under John Bull Radio, Ltd., and see that it gets right home, but I can assure all overseas readers that, when we get down to it, they will have the goods that rebut any challenge.

Your journal will champion anyone, experience tells me, who has a genuine shortcoming to lay bare, and you, sir, have done everything to get us one and all a circuit diagram of the set we buy, and your efforts have been rewarded in service being better attended to generally, and it is to be hoped that more can be done during next season here to make the manufacturer conscious of the market he misses Down Under every summer.

I think that we are all confident that we can give the world a square deal with a British-made radio set, so why not give that waiting world a New Deal (radio variety)?

NOW OR NEVER.

Southgate, London, N.14.

Tone Compensation

AS a humble seeker of realistic reproduction, the article on tone compensation in your issue of August 30th greatly interested me. I hope my impressions do not distort the true facts, but it seems that your contributor is unable to prove tone compensation is worth while.

Owing to the "efforts" of the control engineer at the broadcasting station, tone compensation cannot be carried to its logical conclusion. It is obvious the control room is not blameworthy (rather the reverse) when announcers' voices are put out at volume levels having no relation to the musical items which are being described.

Quite apart from the circuit complications and not inconsiderable costs involved in fitting the extra boosting valves, there are one or two aspects of the case of which no mention is made in the article.

I refer to the action of a moving-coil loud

The Wireless World

THE PRACTICAL RADIO JOURNAL
25th Year of Publication

No. 838.

FRIDAY, SEPTEMBER 20TH, 1935.

VOL. XXXVII.

No. 12.

Proprietors: ILIFFE & SONS LTD.

Editor:
HUGH S. POCOCK.

Editorial,
Advertising and Publishing Offices:
DORSET HOUSE, STAMFORD STREET,
LONDON, S.E.1.

Telephone: Hop 3333 (50 lines).
Telegrams: "Ethaworld, Sedist, London."

COVENTRY: Hertford Street.
Telegrams: "Autocar, Coventry." Telephone: 2520 Coventry.

BIRMINGHAM:
Guildhall Buildings, Navigation Street, 2.
Telegrams: "Autopress, Birmingham." Telephone: 2971 Midland (4 lines).

MANCHESTER: 260, Deansgate, 3.
Telegrams: "Iliffe, Manchester." Telephone: Blackfriars 4412 (4 lines).

GLASGOW: 26B, Renfield Street, C.2.
Telegrams: "Iliffe, Glasgow." Telephone: Central 4857.

PUBLISHED WEEKLY. ENTERED AS SECOND CLASS MATTER AT NEW YORK, N.Y.

Subscription Rates:
Home, £1 1s. 8d.; Canada, £1 1s. 8d.; other countries, £1 3s. 10d. per annum.

As many of the circuits and apparatus described in these pages are covered by patents, readers are advised, before making use of them, to satisfy themselves that they would not be infringing patents.

CONTENTS

	Page
Editorial Comment	317
Highly Sensitive Quality Receiver	318
Measuring Ultra-Short Wave-lengths	320
Unbiased	324
Current Topics	325
Locating Wrecks	326
Paris Radio Show	328
Television Experiments	331
Listeners' Guide for the Week ..	332
Thyratrons	334
Broadcast Brevities	336
Letters to the Editor	337
Manchester Radio Show Plan and List of Exhibitors	338

EDITORIAL COMMENT

Radio Exhibitions

Failure of a Compromise

NOW that we are nearing the end of the Exhibition season, the opportunity is provided for considering how far the London, Berlin and Paris shows have succeeded as opportunities for the technically-minded members of the public to form an opinion as to what technical developments have taken place during the year.

We must confess that if we had visited these shows as ordinary members of the public without having access to the reports published in "The Wireless World", it would have been very difficult to collect more than scanty information to meet our requirements. The fact is that in the past few years the radio exhibitions have been organised more and more to appeal to the general public and impress them with the attractiveness of radio sets in outward appearance and their utility from the point of view of entertainment or interest in the home, but the scientific and technical side of wireless has been so far neglected that the exhibitions no longer attract the engineer and technician as an occasion on which scientific knowledge on the design of modern wireless receivers can be acquired.

Separate Technical from Popular Appeal

Some firms exhibiting at these shows have made efforts to compromise with the popular and technical tastes by making available to the public a limited amount of technical information on their exhibits, but where the majority of the visitors are not technical and are often attracted to the exhibition only by the side-shows, such

an effort can, at the most, be only a compromise. As the exhibition idea is at present developing, we run considerable risk of overlooking that this great new industry is built up on an interesting new science, and we would urge that some steps should be taken to correct this state of affairs.

We believe that at every radio exhibition accommodation should be provided for a technical section where circuit diagrams and receiver chassis would take the place of cabinets, and where demonstrations could be given of the application of measuring instruments and other tools of the designer of receivers. Such a section could be made absorbingly interesting and would contribute towards maintaining that interest on the part of the public in the technicalities of wireless which we feel it is of the utmost importance to foster in the interests of the future of the industry.

Stimulate Public Interest

We are very rapidly reaching a stage where sets will sell on the maker's name and the appearance of the receiver alone, and technical improvements will play a decreasingly important part in influencing the public choice. Some attempt should be made to encourage the general listener to a better understanding of the advantages which improvements or new developments in receiver design provide. It has probably been a mistake to attempt to compromise at exhibitions between popular and technical appeal, but a technical section would relieve the general salesman of the embarrassment of technical enquiries, whilst such a section would be staffed by engineers competent to deal with the interests of the technically intelligent visitor, and public discrimination in wireless would be lifted to a higher plane.

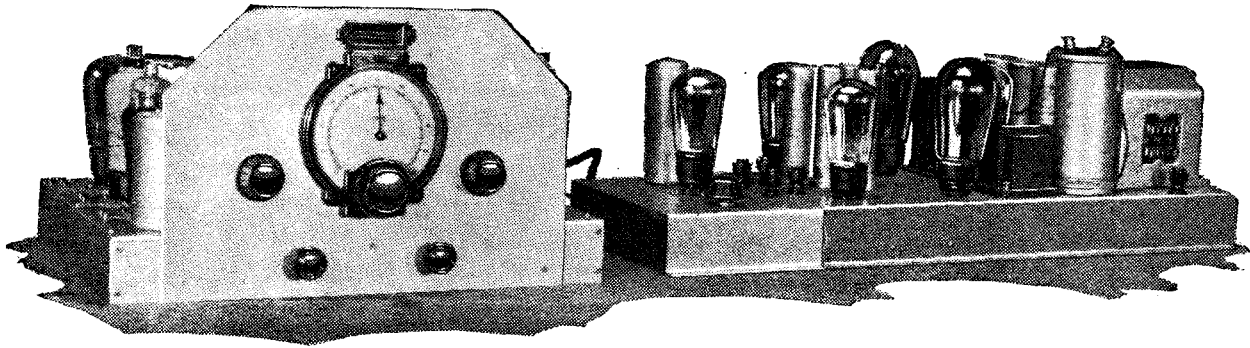

Highly Sensitive Quality Receiver

Linking the 1936 Monodial AC Super with the Push-Pull Quality Amplifier

By W. T. COCKING

IN response to many requests, full details are given in this article of the modifications required by the 1936 Monodial AC Super when it is used to drive the Push-Pull Quality Amplifier. The alterations are few and consist of the introduction of a small amount of tone correction

THE requirements of high-quality reproduction and freedom from interference are mutually incompatible, for the one demands the full reproduction of the highest musical frequencies while the other calls for their suppression. No more than a very minor amount of interference is tolerable, so that if the ratio of signal strength to interference were the same for all stations high-quality reproduction would be an impossibility. Fortunately, this is not the case, and in practice the level of interference tends to remain more or less constant. This is, of course, only a very rough estimate, but the result which follows from it is true. This result is that the ratio of signal to interference increases as the signal strength grows.

In most districts, therefore, there are some stations which are so much stronger than the interference that the latter can be thought of as virtually non-existent. It is consequently quite possible to obtain the highest standard of reproduction from these stations, but on weaker stations some restriction of the upper frequencies becomes necessary. As the wanted station gets weaker and more closely approaches the interference level, the high-frequency response must be further curtailed, and eventually, on very weak signals, it may be undesirable to reproduce frequencies higher than some 3,000 c/s. On considering these facts it is evident that the frequency response should be variable in order to permit the best balance between quality and interference to be obtained on any station. Such a variable response is most conveniently obtained in practice by means of variable selectivity, and it is

easy to see that this fitting is one of the most important of recent developments from the point of view of quality.

The 1936 Monodial AC Super, constructional details of which appeared in *The Wireless World* for July 26th and August 2nd, 1935, includes an efficient system of variable selectivity, and as it is both sensitive and selective, and has an efficient AVC system with automatic muting between stations for noise suppression, it is an ideal receiver for all who require the best reproduction not only from local stations but also from a large number of distant transmissions. As originally described a pentode output valve was employed, and, although the performance from all points of view is far

tion which is second to none on the score of its freedom from all forms of distortion. It consequently forms ideal equipment for use with the 1936 Monodial where the highest possible standard of reproduction is required under all circumstances. The original pentode output stage, however, is still suitable for those who wish to limit the cost of the equipment or who intend it more for distant reception than for local.

The modifications necessary to the Monodial for use with the Push-Pull Quality Amplifier are of a minor nature only, and consist merely of changes made to modify the frequency response to suit it to a triode output stage. Even with the lowest selectivity there is some loss of the highest frequencies, and this was originally corrected by the output pentode. It now becomes necessary to do it in an earlier stage, but the degree of sideband cutting is so small that ample correction is secured by the simplest means. A 0.0001 mfd. condenser Ca and a 4MΩ resistance Ra in parallel are joined in series with the detector output. In effect, these components form a potentiometer with the volume control and its associated parts—the ratio of the arms of this potentiometer being variable with frequency.

The operation is easy to understand when it is remembered that at low and medium frequencies the reactance of Ca is very high compared with the resistance of Ra. The transmission between the detector and LF valve, therefore, is cut down by an amount which depends upon the values assigned to the components concerned. At high frequencies, however, the reactance of Ca is small compared with Ra and also small

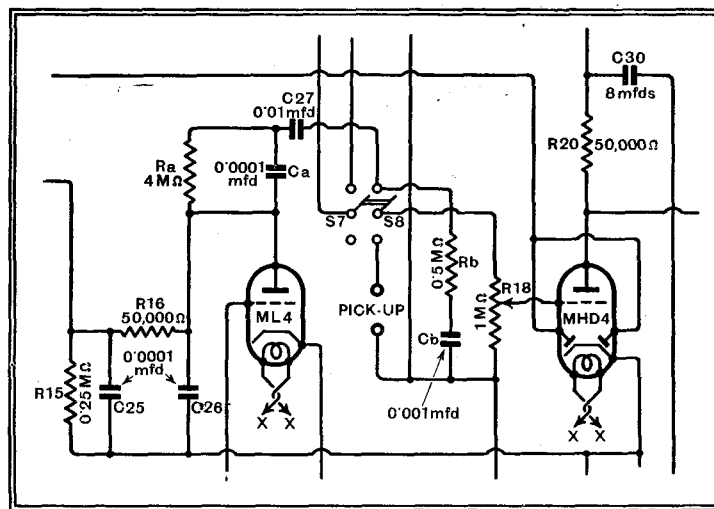

Fig. 1.—The only changes needed in the Monodial are the introduction of Ra, Rb, Ca, Cb, and the change in value of C27.

above the average, there is no doubt that it can be improved still further in cases where considerable volume is necessary by the use of more elaborate low-frequency equipment.

The *Wireless World* Push-Pull Quality Amplifier has earned for itself a reputa-

Highly Sensitive Quality Receiver—

compared with the volume control circuit, so that high frequencies are passed unimpaired. The circuit, therefore, emphasises the high frequencies relative to the medium and low.

The Bass Response

Two further changes have been made, the reasons for which are not at first sight apparent. The first is in the value of C27, which has been reduced from 0.1 mfd. to 0.01 mfd. This has been done in order to reduce the efficiency of coupling at this point at very low frequencies only. It has been found that when an amplifier has such a good response at low frequencies as the Push-Pull Quality Amplifier motor-boating can occur under certain circumstances. The feed-back occurs at such a low frequency that decoupling will not always prevent it. In early low-frequency stages adequate decoupling can be used, for the anode currents of the valves are so small that high values of decoupling resistance can be employed without causing an excessive voltage drop. In the IF amplifier, however, a high anode voltage is needed on the valves, and the anode current is too large to permit the decoupling resistance to be more than a few thousand ohms. Even in such a stage motor-boating or a modification of the frequency response may occur through feed-back, for low-frequency variations in the H.T. supply may modulate the carrier at the intermediate frequency.

It should be remarked that feed-back effects of this nature are not serious with

so attenuating the extreme bass. This results in a great attenuation at the very low frequencies below 10 c/s at which feed-back occurs, and some attenuation at higher frequencies where it is undesirable. This is corrected, therefore, by the addition of Rb of 0.5 MΩ and Cb of 0.001 mfd. These components tend to give a rising characteristic at low frequencies, but a rise which does not extend below some 30 c/s. The net result is a flat response down to about 30 c/s with a sharply falling characteristic below some 20 c/s, and although the response is maintained over the full range of audible frequencies it is reduced at the sub-audible frequencies, where it is harmful.

These alterations are the only ones necessary to the Monodial for using it with the Push-Pull Quality Amplifier, and the overall frequency response obtained is shown by the curve of Fig. 2. The variations do not exceed ±2 db. from 30 c/s to 10,000 c/s. This is an exceptionally good performance when it is remembered that it includes the variations in receiver, feeder, amplifier, and output transformer; the whole receiving equipment, in fact, except the loud speaker.

Turning now to the equipment, the modifications to the receiver have been described and are clearly shown in the photographs and drawings. The Push-Pull Quality Amplifier requires no alterations and is connected to the receiver via the feeder unit described in *The Wireless World* for August 16th, 1935. The connections are straightforward, the aerial and earth and pick-up

placed alongside the amplifier and the terminals connected together. The receiver plug must be inserted into the socket on the feeder unit and the feeder plug into the one on the amplifier, the loud speaker plug being inserted into the speaker

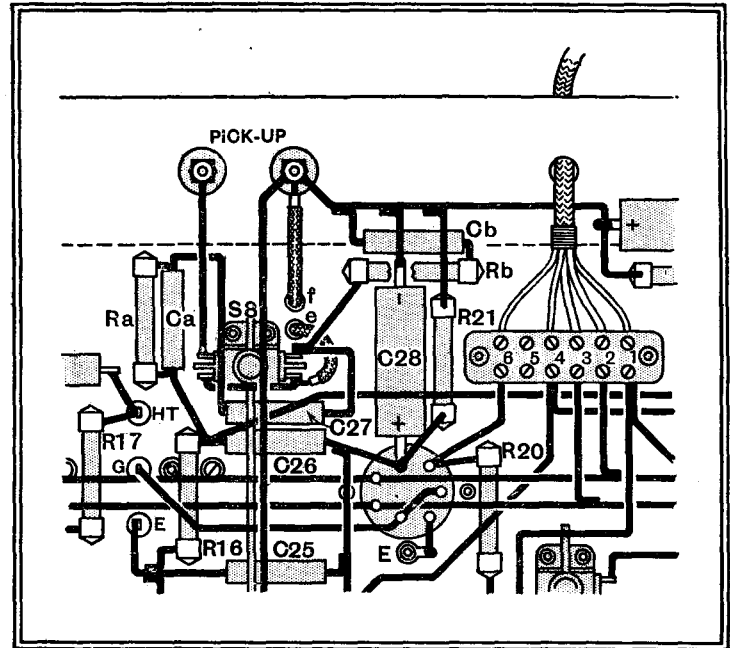

The alterations are all shown in this drawing of a portion of the underside of the receiver.

socket on the amplifier. The connections to these plugs are all identical with those described in the constructional articles on the different units. The amplifier and feeder chassis need not be insulated from one another, but they must be insulated from the receiver chassis and from earth, since there is about 3 volts potential difference between them. Nothing special in the way of insulation is needed, and provided they are not standing on a metal shelf it is sufficient merely to see that they do not come into contact.

LIST OF PARTS		
1 Resistance, 4 megohms, 1 watt, Ra	Dubilier	
1 Resistance, 0.5 megohm, 1 watt, Rb	Dubilier	
1 Condenser, 0.0001 mfd., tubular, Ca	T.C.C. 360	
1 Condenser, 0.001 mfd., tubular, Cb	T.C.C. 300	
1 Condenser, 0.01 mfd., tubular, C27	T.C.C. 300	

In the matter of the initial adjustments no change from the procedure described in *The Wireless World* for July 26th and August 2nd, 1935, for the receiver, and in the issue for August 16th, 1935, for the feeder unit is recommended. It is advised, however, that the latter adjustment be made first with the aid of a gramophone record and pick-up if this be available. The power unit of the Monodial is not, of course, needed when the Push-Pull Quality Amplifier is used.

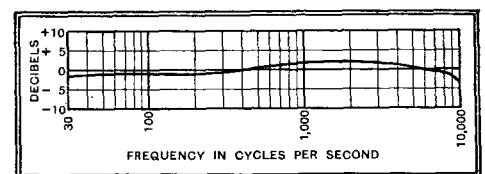
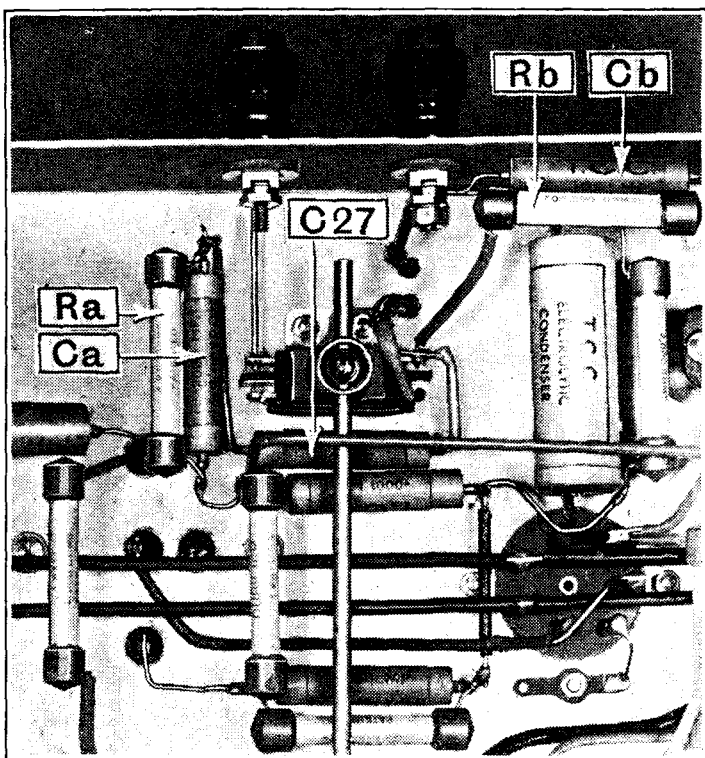

Fig. 2.—The overall frequency response shows that all musical frequencies are evenly reproduced within about ± 2 db.



The positions of the new components are clearly shown in this illustration.

a push-pull output stage until the output stage is overloaded. It has, however, been thought desirable completely to remove it by reducing the value of C27 and

being connected to their respective terminals on the receiver. No connection must be made to the earth terminal on the amplifier. The feeder unit should be

Measuring Ultra-Short Wavelengths

Alternative Methods for the Amateur to Calibrate His Apparatus

By M. G. SCROGGIE, B.Sc., A.M.I.E.E.

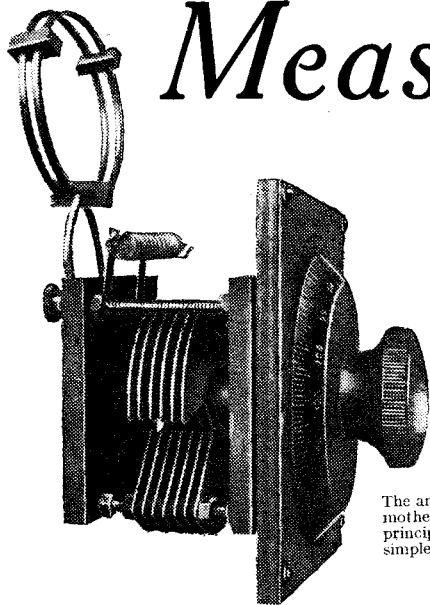

The amateur's fairy god-mother; the absorption principle is used in the simplest possible type of wavemeter.

RECEPTION of ultra-short wavelengths, though differing greatly from work on normal broadcast bands, is simple enough; the necessary apparatus is also inexpensive. But, as pointed out in this article, the amateur is apt to lose himself in the vast band of frequencies opened up to him in this new sphere; simple ways out of this difficulty are described.

THE first and chief difficulty when making acquaintance with ultra-short wave reception is the same as that of the airman coming down through the clouds over an unknown country—the difficulty of finding out where he is. When putting a new medium- and long-wave set “on the air” for the first time, even if it is only firing on three cylinders, so to speak, and there is no wavemeter handy, it is quite easy to make contact at least with the local station, and so gradually to get the tuning into order.

But on the television and other waves, 5-10 metres, there are at the moment no entirely regular and definite daily transmissions to rely upon in any part of the country; certainly not all over the country. In any case there is not likely to be anything so powerful as a medium-wave local. And, lastly—and this will apply even when the waveband contains a number of landmarks—searching from 5 to 5.1 metres is equivalent to searching over the entire medium band from 200-600 metres and the long-wave band! So it is an excessively tedious business if one is rather hazy as to the calibration of the receiver.

Radiating and Non-radiating Meters

It is not proposed here to give full constructional details of any particular wavemeter. For one thing, the type about to be recommended is so very simple that it is easy to make one, probably from spare materials, to cover any desired waveband.

There are two chief types of wavemeter: the heterodyne and the absorption. The former is the sort most in demand on the longer waves. It is simply a calibrated valve oscillator. Simple, maybe; but not nearly so simple as the absorption type, which is nothing more complicated than a coil tuned by a variable condenser. Its scope is limited to measuring the wavelengths of transmitters, oscillators, and receivers that can be made to oscillate. Broadcast receivers,

being increasingly superhets., in which oscillation at signal frequency is strictly prohibited, demand a wavemeter of the oscillating type to furnish a signal. But on the ultra-shorts one's first essay is usually with an oscillating receiver, probably a super-regenerative; and even if it is a superhet., most of the wavelength problem has been solved when the oscillator wavelength has been measured.

By the way, it has been rather difficult to decide whether to write this article in wavelengths or frequencies. The author's own choice inclines towards frequencies as being definitely and logically right. On the other hand, the term covers a wide field, including audio and intermediate frequencies, or even that of the supply mains; whereas wavelength is associated more definitely with the signal frequency. It is also linked up more directly with certain methods of measurement at very high frequencies. And it has, moreover, a more homely sound for the less sophisticated and expert reader. So, if any of the other sort of readers are present, they will please mentally read “frequency” where “wavelength” appears.

Going back to our wavemeters: the absorption type has the further advantage—which is considerable when one's position is uncertain within wide limits—of not causing any ambiguity due to harmonics. It is much cheaper than a heterodyne type, more portable (owing to lack of batteries), more reliable, and there are fewer things on which its accuracy depends. A specimen, which is not put forward as the ideal, is illustrated at the head of this article; it is a very old wavemeter originally intended for transmitters between 20 and 170 metres. Fitted with the extra two-turn coil shown, it makes a very useful wide-range meter, covering 4 to 14 metres. A small neon tube (from an ignition tester) for indicating resonance when coupled to a transmitter is retained in parallel with the coil and condenser so as not to upset the original calibrations.

The condenser is a specially built one with shaped plates widely spaced, about 150 mmfds.; and the coil has two turns 2in. in diameter of 12-gauge copper wire, supported by three ebonite spacers. For experimental work it is very useful to cover such a wide range, but, of course, it is not possible to take very close readings. For covering a restricted band in detail, one must have an additional wavemeter in which only a very small part of the capacity is variable—perhaps only 1 or 2 mmfds.—and it is then essential to take great precautions (1) to avoid shifting of calibration by making the whole circuit exceedingly rigid, and (2) to avoid hand capacity effects by mounting the condenser and coil on the end of a long shaft with an extension control spindle, free from back-

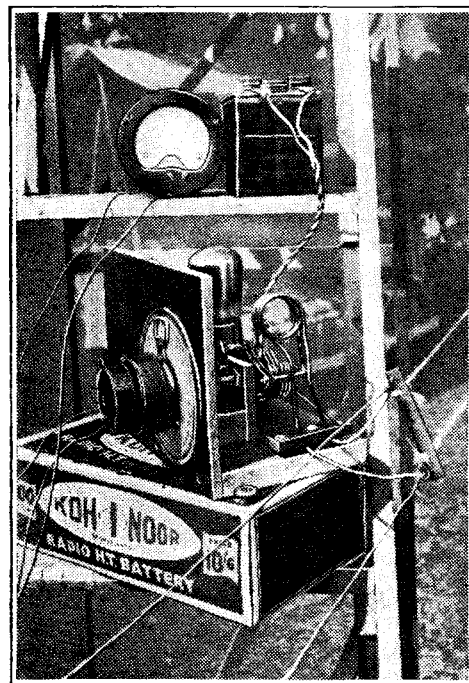

An oscillator (circuit given in Fig. 1) coupled to a Lecher wire system.

Measuring Ultra-Short Wavelengths—

lash or whip. In parallel with the tiny variable condenser there should be a very constant fixed air capacity of at least 25 mmfds., with all losses due to mountings, etc., reduced to a minimum.

To give a rough idea of the coils needed for tuning at these wavelengths, two turns may be tried for a coil 2in. in diameter, four turns for a 1½in. coil, and seven or eight for a 1in. coil. They may afterwards be altered if necessary to cover the desired band more exactly.

Although an oscillating wavemeter is not advised as a standard, it is essential for some sort of oscillator to be available; but as it is not to be the calibrated standard there is no need to worry particularly about building it to wavemeter grade of construction. Any oscillating receiver may be used, but it is simple and cheap to make up a separate oscillator, and it is a very useful thing to have about the place.

The example shown in Fig. 1 is more complicated than it need be, because it is a modulated oscillator. The circuit is drawn with the modulator part in thinner line, so that it is easily seen what may be omitted.

The five-turn coil, 1in. in diameter, is exactly centre-tapped and tuned by an Eddystone 25-mmfd. "Microdenser." The ideal in ultra-short wave work is to eliminate leads so far as possible in the oscillating circuits; the battery feed circuits are isolated close up by means of chokes wound with about fifty turns of 26 S.W.G. or thereabouts on ½in. tubes. The oscillator valve shown is a Mullard PM 2DX, because it was desired to be able to run it rather powerfully in certain cases; but for ordinary purposes the Hivac XL valve is much to be recommended because of its extremely small size and consumption. Using it, one can build portable apparatus complete with batteries in an amazingly small space.

Resonance Indications

The modulator choke is a Varley tapped three-henry component, and with a 0.01 μF condenser gives a pleasant note of some 800 cycles per second. Preferably a milliammeter reading up to about 5 mA is attached and used as an indicator. Alternatively, phones may be used in the same position; otherwise the terminals are shorted.

The absorption wavemeter is used by bringing it near an oscillator provided with a meter as described, and tuning it until the meter shows a kick; upwards in the case of an oscillator using a grid-leak and downwards if not. If the wavemeter is coupled closely to the oscillator coil, the

oscillator may stop altogether. In any case the disturbance of the pointer will be unnecessarily large, and the wavemeter should be moved gradually away, at the same time tuning it to and fro through the resonant point until the meter kick is only just easily perceptible. With a little practice, the exact point can be very accu-

when the pitch of the beat note is the same as it is when the wavemeter is widely off tune. This system is the correct one for accurate work on longer waves, but is almost too sensitive for our present purpose.

So much for the apparatus and how to use it; now for methods of getting known wavelength points. As remarked earlier, the chances of picking any up from stations are remote. The first method is for those who have a heterodyne wavemeter or accurately calibrated test oscillator for some longer wavelengths. If falling within the category of "short," in the region of 20 or 30 metres, the process is likely to be fairly easy, but at medium waves it may be necessary to do it in two stages, temporarily calibrating a short-wave oscillator, and thence the ultra-short.

The principle, of course, is the well-known one of harmonics, and there are various ways of actually making the comparison, the most suitable depending on the gear available.

The simplest is to place the ultra-short-wave oscillating receiver near the longer wave oscillating wavemeter, and tune the latter very slowly indeed, beginning at the shortest wave possible. Note very exactly the wavelength at which the first whistle is heard in the receiver. It is 27.3 metres, say. Then note the next, and as many others as possible. Put them down in a column, take the differences between each reading, and take an average of the differences.

Wavelength.	Difference.	Calculated Wavelength.
27.3		6.83
	6.7	
34.0		6.80
	7.0	
41.0		6.83
	6.5	
47.5		6.79
	7.0	
54.5		6.81
	—	
Average		6.8

The "answer" is 6.8 metres. A more

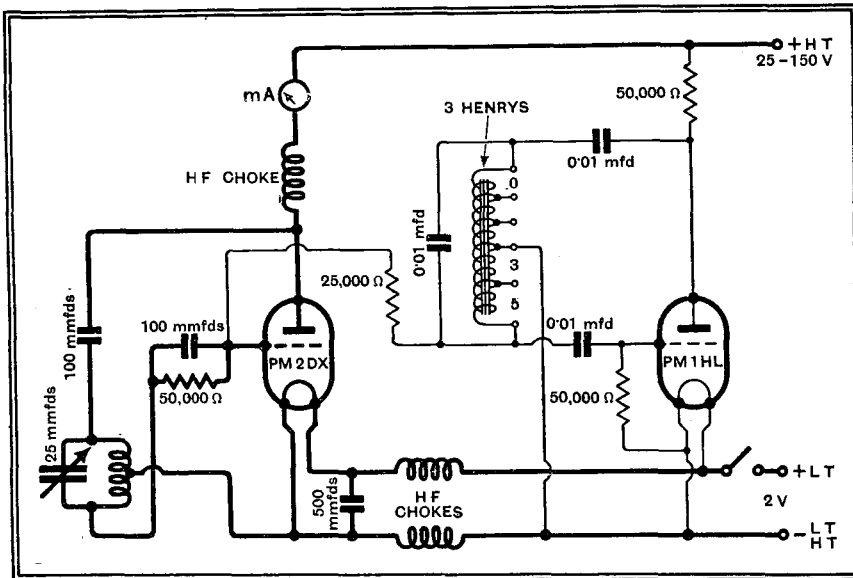

Fig. 1.—Circuit of a modulated oscillator; modulation may be omitted by ignoring connections shown in light lines.

rately set. To facilitate the process, it is a good thing to try a rather high-resistance oscillator grid leak so that the dependence of the anode current on the strength of oscillation is very large. The extent of it can be tested by grasping the oscillator coil in the hand, causing oscillation to cease.

With strong oscillation and a high-resistance grid leak it is probable that the oscillator will start "squegging"—self-modulating, with a very big drop in anode current. This is unobjectionable with a meter indicator; in fact, very beneficial; but not with phones. In any event, phones do not give a very satisfactory indication, but as they may have to be used if the oscillator happens to be a receiver it should be noted that the method is slightly different; the reaction control is set until oscillation is only just maintained, and the absorption wavemeter causes it to cease altogether at the critical point. And it should be a point, not a whole band; if the latter, it is a sign that the wavemeter must be held farther away.

There is a method using phones (or loud speaker if there is enough amplification) that is actually by far the most sensitive and accurate of any, but it necessitates oscillator and oscillating receiver. The two are set to give a beat note in the phones, which of course varies if either is mistuned to the slightest degree. If the wavemeter is tuned through the oscillator as in the previous scheme, at a distance beyond that at which the slightest flicker is shown by a meter, the beat note rises, suddenly drops, and then more slowly rises; or the whole sequence takes place upside down. The exact tuning point is the middle of the sudden drop (or rise)

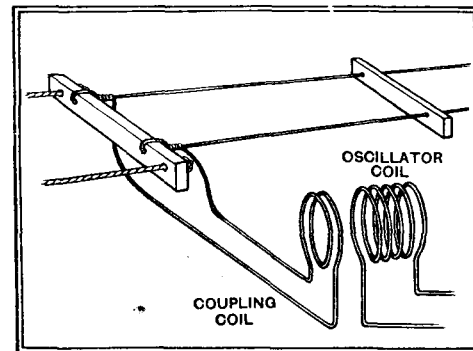

Fig. 2.—Diagrammatic sketch showing method of coupling the oscillator.

Measuring Ultra-Short Wavelengths—

accurate way of using the results is to divide each of the wavelength readings in the first column by the whole number giving the nearest to 6.8. Thus it is obviously the fourth harmonic of 27.3 metres that caused the whistle, the fifth of 34, and so on, and dividing by these numbers gives the figures in the third column. It will be noticed that they are much more consistent than those in the second.

An absorption wavemeter can be calibrated along with the receiver by any of the methods already described. Alternatively, if there is provision for phones on the standard wavemeter, an ultra-short wave oscillator may be coupled to it and used to beat with the wavemeter har-

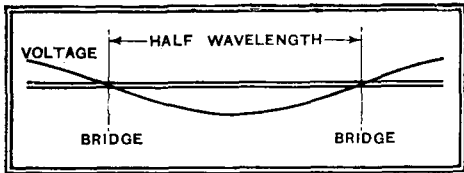

Fig. 3.—Distribution of voltage along parallel wires.

monics. This is rather less likely to be successful, however.

After a single point has been found in one of these ways, others follow, and are plotted on a chart to give a complete calibration all over the scale in the usual manner.

When the known wavelengths are much longer several difficulties arise. The second column figures, being differences between much larger figures, may be so irregular as to be valueless. It may be impossible to tell the number of the harmonic definitely, for getting third-column figures. And in any case the harmonics are likely to be so feeble as to be inaudible.

Measuring Waves—with a Foot Rule!

So we pass on to the next standard of wavelength, which is the Lecher wire system. This is just a pair of parallel wires strung up as far as possible from the ground and other objects. They should be at least 30 feet long, and not less than about 4 feet from the ground. The distance apart is not vital, 2 or 3 inches will do, but they *must* be parallel. Cut a dozen small strips of ebonite or other good insulating material—dried and waxed hardwood can be used—and drill holes at each end just large enough for the strips to be slid along the bare copper wire as spacers. The wire must previously have been stretched to remove kinks, and it should be clean. Suspend the ends some feet away from walls or trees by means of cord, *not* wire.

One end of this double wire is to be coupled to the ultra-short wave oscillator; of the various methods probably the most convenient is one or two turns of wire coupled fairly closely (Fig. 2). The anode milliammeter is essential, and it is a great advantage if there is a large difference between the readings in the oscillating and non-oscillating conditions. A grid leak of several megohms is a help in this.

Now make a sort of tramway trolley by pushing a short length of stiff wire through the end of an insulating rod to form a T-piece, and beginning at the end near the oscillator, drag this along the two lines so as to short-circuit them, keeping an eye on the meter. At a distance of several feet the needle will probably show signs of life, reaching a maximum at a certain point. To discover the exact point it may be necessary to substitute for the tramway contact a short double crocodile clip lead, arriving at it by successive trials (for the hands must be completely removed from the neighbourhood of this bridge each time). When the position of maximum meter deflection has been found mark it by tying a piece of thread round one of the Lecher wires, and before removing the bridge note the reading of the absorption wavemeter (on any arbitrary scale) when tested on the oscillator. Now remove the bridge and run the tramway farther along to find another similar point, at which repeat the process. By this time it may be necessary to enlist assistance for observing the meter needle and reporting thereon from a distance. Check the oscillator with the absorption wavemeter again, and it is quite a good precaution to go back to the first marked point with an extra bridge and redetermine the exact place with the other bridge still in position.

The distance between the two bridges in metres is half the wavelength. If the Lecher wire is long enough a third or even fourth point may be found as a check. If all is well they should be spaced at equal intervals. Then the whole business has to be repeated for each additional point on the wavemeter scale. Five or six points ought to give a good calibration.

This is an interesting method and almost worth playing about with for its own sake, as giving a more direct idea of wavelength than perhaps anything else. The distribution of inductance and capacity along a parallel wire system is such as to bring about a complete reversal of phase every half-wavelength. The distribution of voltage is as shown in Fig. 3. If the wires are not parallel, the distribution of capacity is obviously not uniform, and if the wire is curled up at some place, the distribution of inductance is likewise non-uniform; so, when means are employed to couple one end of the wire to an oscillator, the first length of wire cannot be depended upon for measurement. It could be made right by tuning the coupling coil, but there is no need.

The method is not enormously accurate, even if well done; there is a distinct tendency for the wavelength as measured to be less than the true value. But it is good to within a very few per cent. if carefully carried out. And it is easier and

more convenient just when the harmonic method becomes difficult, that is, when the wavelength is very short. So when we drop to even shorter waves, say 2 or 3 metres, it may be practicable indoors, where we are independent of the weather.

The Quarter-wave Method

To make sure of avoiding out-of-doors work one may employ a definitely indoor modification known as the quarter-wave resonator. This is also a parallel wire, but only a quarter the length of the longest wave to be measured, so that a 6-foot wire goes up to over 7 metres wavelength. The wires may either be strung up across the room or mounted more or less portably in a rigid wooden frame. As the presence of insulating material between the wires is a source of error, it is best to do without any spacers, stretching the wires tightly between supports and taking very great care to get them exactly parallel. The farther apart, the less any error of parallelism, but the greater the error due to supports and any other insulating or conducting body in the neighbourhood. About 2in. separation is a good compromise. There is appreciable error—1 per cent.—if a wooden board is brought within a fraction of an inch of the wires, and metal may cause such an error within several inches.

One end of the wires is left unconnected and the other shorted by a straight double-clip wire. As it is hardly convenient to shorten the wires themselves to correspond to shorter wavelengths, the bridge wire is shifted along from the end for tuning purposes. When the bridged end is brought near an oscillator coil to

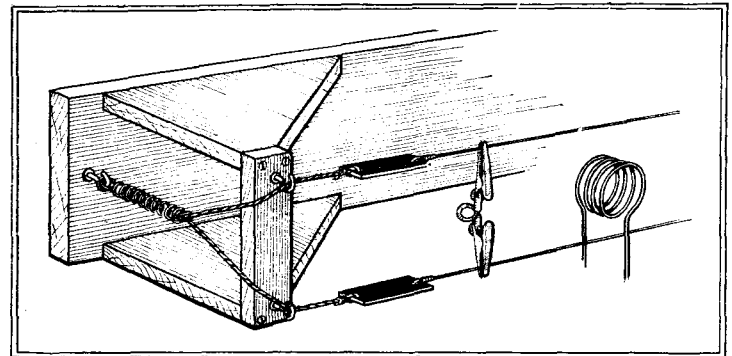

Fig. 4.—Construction of a parallel-wire resonator, showing position of oscillator.

which it resonates, it loads the oscillator and causes the usual meter indication. Fig. 4 shows how they should be placed for coupling, and also the construction of the resonator, but when an indication has once been obtained the two should be separated as far as possible for greatest accuracy.

Unless a rough idea of the oscillator wavelength is known it may be rather a tedious business getting it and the resonator into tune. If the resonator is tuned to the oscillator a tramway contact has to be used as for the preliminary adjustment of the Lecher wire; and, as the oscillator should not be *too* far from the bridge, and on the free end side, it is necessary to move

Measuring Ultra-Short Wavelengths—

the oscillator along occasionally, this being a welcome alternative to moving the wire system. On the other hand, the oscillator may be tuned to the wire, but unless the adjustment is over quite a small range it may not be easy to spot the critical point in the movement of the meter. The reading is likely to vary to some extent with tuning in any case, and this is liable to mask the desired indications.

However, it is possible to get within about 1 per cent. of the right wavelength by this means. As with the Lecher wire, the tendency is for low readings. As a matter of interest, it may be noted that the resonator can be made to form an oscillating circuit by connecting it in the anode circuit of a valve as in Fig. 5, and tuning the grid until oscillation starts, or the grid and anode positions may be reversed. To get sufficiently "close" coupling for the purpose it may be necessary to connect the resonator at some dis-

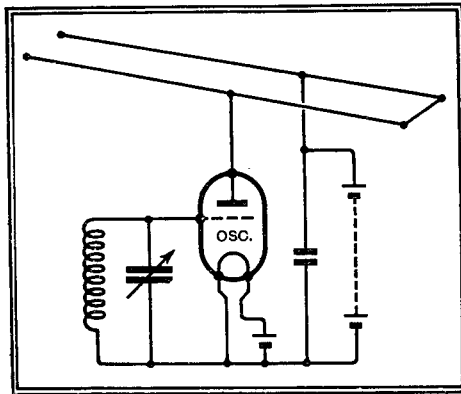

Fig. 5.—A parallel-wire resonator as part of an oscillatory circuit.

tance from the bridged end—perhaps a third of the way along. The capacity thus thrown in parallel with the wires is one reason why this idea is unsuitable for accurate measurement. But it is useful for a rough preliminary test.

In Next Week's Issue

The 1936 Battery Monodial Super

A Sensitive Quality Receiver with Variable Selectivity

THE characteristics of a battery receiver are different from those of a mains set only in so far as changes are necessitated by the source of power from which it is operated. Economy of power becomes of importance, and this is most noticeable in the output stage. Too great attention to economy, however, results either in poor quality or in acceptably low volume. In the design of the 1936 Battery Monodial Super, therefore, no effort has been made to keep the current consumption within the rating of a small dry battery, and the set is intended for operation from accumulators or large capacity dry batteries.

In general features it follows closely the lines of its AC counterpart. A signal-frequency HF stage is used with two tuned circuits. The frequency-changer is a heptode which feeds two IF stages functioning at a frequency of 465 kc/s and including variable selectivity. A duo-diode-triode provides detection, delayed AVC, and LF amplification, and feeds the output stage through a high-quality LF transformer. The output stage is of the QPP type employing two double-valves and giving an output of up to some 2 watts according to the HT supply available.

The sensitivity and selectivity are adequate for distant reception under practically all conditions, and the quality of reproduction reaches a very high standard. The AVC system gives a wide range of control and largely counteracts fading, and a tuning indicator is included to permit the correct adjustment of the receiver.

THE LIST OF PARTS

RECEIVER UNIT.

- 1 Three-gang condenser, 0.0005 mfd. Utility "Mite" 347/3 (Polar, J.B.)
- 1 Tuning dial assembly, drive and escutcheon Formo "Snail" (Polar, J.B., Utility)
- 3 Variable-selectivity I.F. transformers, 465 kc/s Sound Sales 465/VFT (Wearite)
- 3 Trimmers, 0.0003 mfd. Sound Sales 3VC
- 1 Aerial coil Bulgin C6
- 1 HF transformer Bulgin C7
- 1 Oscillator coil, 465 kc/s Bulgin C59

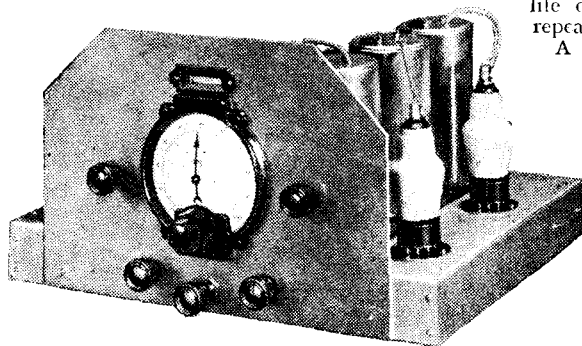

The receiver and output stage.

- Fixed Condensers.**
 - 4 0.0001 mfd. Dubilier 665
 - 2 0.0002 mfd. Dubilier 665
 - 1 0.0003 mfd. Dubilier 665
 - 1 0.001 mfd. Dubilier 670
 - 1 0.015 mfd. tubular Dubilier 4502
 - 10 0.1 mfd. tubular Dubilier 4503
- (Ferranti, Graham Farish, Peak, Polar-N.S.F., T.C.C., T.M.C. Hydra)
- Resistances, 1/2 watt.**
 - 4 2,000 ohms Ferranti G.5
 - 3 20,000 ohms Ferranti G.5
 - 1 50,000 ohms Ferranti G.5
 - 2 100,000 ohms Ferranti G.5
 - 1 250,000 ohms Ferranti G.5
 - 1 1 megohm Ferranti G1
 - 1 2 megohms Ferranti G1
- (Amplion, Bryce, Bulgin, Dubilier, Erie, Graham Farish, Claude Lyons, Polar-N.S.F., Watmel)
- 4 Valve holders, 7-pin Goltone R20/721
- 1 Valve holder, 5-pin Goltone R20/521 (Belling-Lee, Clix)
- 1 10-way connector Bryce
- 1 5-way cable assembly, 30in., complete with plug Goltone
- 1 5-way cable with wander plugs and spade ends, 30in. Goltone "Court" R59/385
- 1 Magnetic visual tuning meter Bulgin VT50
- 4 Ebonite shrouded terminals, A., E., Pick-up (2) Belling-Lee "B"
- 1 Tapered volume control, 1 megohm Ferranti PG

- 5 SPST switches Bulgin S80B
- 2 SPDT switches Bulgin S81B
- 1 DPST rotary switch Bulgin S115
- 2 Lengths of rod, 9in. and 11in. for above Bulgin
- 2 Reducing sleeves for 5/16 in. shaft Bulgin
- 5 Knobs, 1/2 in. Bulgin K14B
- 1 Valve connector Belling-Lee 1175
- 2 Adaptors Bulgin P68
- 1 Cell, 1 1/2 volts Siemens CT
- 3 Lengths screened sleeving Goltone
- 1oz. No. 18, 1oz. No. 20 tinned copper wire, 10 lengths sistoflex, etc.
- Metal chassis, 16 x 12 x 2in, complete with screws, nuts and washers C.A.C.
- Valves:—
 - 3 210VPT, 1 210PG Cossor
 - 1 HD22 Osram or Marconi
- OUTPUT STAGE.**
 - 1 Push-pull transformer, 1:3.5 Ferranti AF50
 - Fixed Condensers.**
 - 1 1 mfd., 500 volts DC test Dubilier BB
 - 2 0.005 mfd. Dubilier 670
- (Ferranti, Graham Farish, Peak, Polar-N.S.F., T.C.C., T.M.C. Hydra)
- Resistances, 1/2 watt.**
 - 1 150,000 ohms Ferranti G.5
 - 1 25,000 ohms Ferranti G.5
- (Amplion, Bryce, Bulgin, Erie, Graham Farish, Claude Lyons, Polar-N.S.F., Watmel)
- 1 Valve holder, 5-pin Goltone R20/721
- 2 Valve holders, 7-pin Goltone R20/521 (Belling-Lee, Clix)
- 1 3-pin plug and socket Belling-Lee 1119
- 1 9-volt grid bias battery Bulgin 1
- 1 Pair grid bias clips Ecelx
- 2 Wander plugs
 - Small quantity No. 18 and 20 tinned copper wire. 2 lengths sistoflex, etc.
- Metal chassis, 8 x 6 x 2in., complete with screws, nuts and washers C.A.C.
- Loudspeaker, with QPP transformer for 12,000 ohms load Goodmans "Grille" PM M/C
- Valves, 2 QP21 Marconi or Osram
- 1 Cabinet C.A.C.
- 1 2-volt 30Ah. Accumulator Fuller SWXH7
- 1 120-volt HT Accumulator Milnes Super Capacity

DECCA FREQUENCY TEST RECORD

AS a source of standard audio frequencies for use not only in testing pick-ups but also for general experimental and calibration work the Decca Record No. EXP55 should prove invaluable to the amateur. Fourteen frequencies between 50 and 6,000 cycles are provided, and to extend the useful life of the record the same frequencies are repeated on the reverse side.

A table is printed on the label upon which

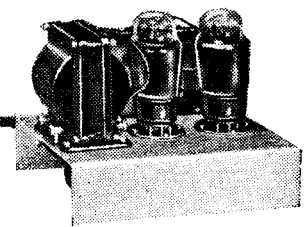

a note of the number of playings can be made. The level in db. of each section is also shown, zero db. being equivalent to the average of commercial music recordings which may, however, rise to approximately 12 db. above this during peaks.

The output is flat within ± 1/2 db. from 6,000 down to 250 cycles and then falls away—the drop in db. being indicated in each case—to -14 db. at 50 cycles. This cut-off follows the average curve for commercial recordings, and the levels given for frequencies between 50 and 250 cycles may be relied upon to ± 1/2 db. These limits are guaranteed only up to 20 playings.

A stroboscope for 50 cycles is also printed on the label, and when run at the correct speed the frequencies are correct to approximately 1 per cent.

This record is sold at the very reasonable price of 2s. 6d., and the makers are The Decca Record Co., Ltd., 1-3, Brixton Road, London, S.W.9.

UNBIASED

By FREE GRID

An Old Spanish Custom

I SEE that a proposal is afoot to provide us all with penny-in-the-slot machines so that we can make records of our own voices. The machines should certainly be well patronised by politicians and others who are fond of the sound of their own voices, but I fear that the inventor of the ingenious apparatus has overlooked one very important psychological fact, but fortunately this is easily remedied.

The fact to which I refer is, of course, the inherent shyness and maidenly bashfulness of the average man in the street, or to put it in more scientific language, the self-consciousness of the ordinary individual. No man or woman, self-respecting or otherwise, is going to stand up brazenly before the multitude and warble a sweet ditty into a thing looking like a glorified weighing machine, not even if they were paid to do so.

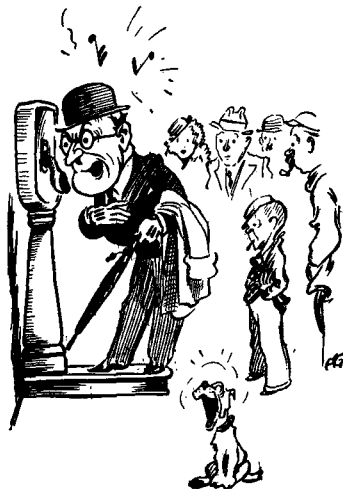

"... warble a sweet ditty ..."

However, as I have said, the trouble is very easily overcome, and in a manner which will have the great advantage of making good a serious defect in nearly all recording systems, viz., their inability to give the proper value to sibilants which are sadly underdone on the average record. Both the courage and the sibilance will be provided in full measure if the machine is caused to deliver a bumper of some potent beverage such as *Aqua Caledonia*. The question of cost need not as a matter of fact trouble the inventor overmuch since there is a cooling drink sold in Spain under the intriguing name of *aguadiente* which should amply meet the case. As a tribute to both its potency and its cheapness, I can vouch for the fact that far less than sixpenn'orth of it is ample to send a whole fo'c'sle full of sailors rolling down to Rio in fine style.

Outwitting the Gongsters

THERE is not very much liberty remaining for the ordinary citizen in this once fair land of ours, and what

little there is seems in grave danger of being taken away. What with the restriction of speed and the licensing hours life is scarcely worth living nowadays, and now it appears that the wretched police, brazenly battenning on the brains of others, have introduced yet another weapon in their ceaseless attack on the defenceless citizen. Nobody is less backward in coming forward when duty calls than I am, and I think that it is no less than my plain duty to make public the result of some investigations I have been making lately into certain police activities.

For some time past reports have reached me of mysterious and apparently causeless car breakdowns on our roads, but I must confess that I paid little heed to them until recently, when the seriousness of the whole affair was brought home to me personally. Owing to several unfortunate clashes with the police gongsters, my family had presented me with a high-powered car the speed of which enabled me to outdistance these predatory pests. I had not long enjoyed my newfound freedom, however, when I again fell into their hands owing to a sudden failure of my engine at a vital moment. This mysterious engine-failure was repeated on several subsequent occasions of a like nature, and my licence began to have almost as many endorsements as a Hollywood fairy's passport. Motor car experts who were called into consultation, including the Editor of *The Autocar*, an old dock-acquaintance of mine, could find nothing wrong with the engine, and it was finally my own native wit and resourcefulness which led me to the solution of the problem.

Suspecting something of the true nature of the cause of my troubles I wended my way to Whitehall and called on a wartime acquaintance who had successfully married himself into an influential position at the War Office. Owing to his good offices I was able to borrow one of the new one-man tanks, and on my first free Saturday afternoon I set out for a jaunt along the King's highway. By dint of some deliberately careless driving, including the successful surmounting of one or two dilatory cars which lay in my path I was able to attract the attention of an obvious police car. Immediately I had done this I opened up the throttle and was not long in hearing the mellifluous note of the gong. Putting on a further burst of speed I soon outstripped my pursuers, and with my binoculars was enabled to observe their chagrined bewilderment as they feverishly twisted the dials of a micro-wave wireless transmitter which occupied a great part of the car.

As I had suspected, the explanation of my previous engine trouble was the so-

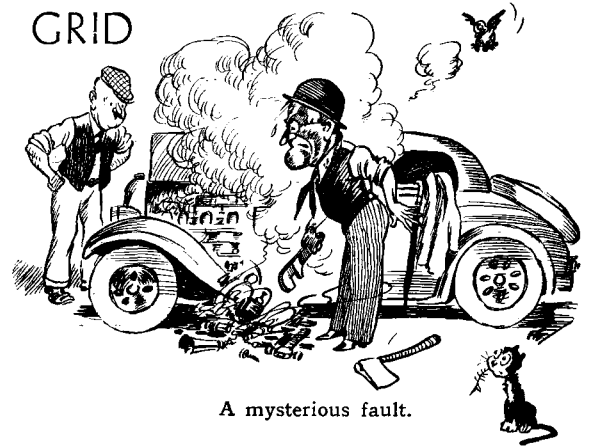

A mysterious fault.

called "death ray," originally put forward some fifteen years ago, which bewildered R.A.F. experts by demonstrating the stopping of a motor cycle engine at a distance by means of this apparatus. In recent months the idea has been revived with a view to bringing down hostile aircraft and it is evident that the police have merely adapted this idea to their own base ends. My tank experiment thwarted them purely and simply because of the almost complete screening of the engine, and it only remains now for me and other peaceful users of the road to screen our car engines properly in order, once more, to enjoy the amenities of the King's highway without let or hindrance from officious Jacks-in-office.

A Master-Mixer?

I WISH to take this opportunity of acknowledging the large number of letters I have received from unemployed musicians concerning the revelations I was able to make recently in the matter of the B.B.C.'s cinematographic activities.

I hear that not only is the B.B.C. preparing to make films of well-known conductors in action, so that in due time they may substitute them for the real thing, but it seems highly probable that a plot is afoot to dispense eventually with the entire symphony orchestra.

From what I hear, separate records have recently been made of the drum and triangle in action and plans are mooted to make a separate record of each instrument in the orchestra doing its stuff in the various popular numbers which are churned out from time to time.

The idea is that, eventually, the hundred odd players will be substituted by a hundred odd turntables, all under the control of a master-mixer. Thus, the fabulous salaries at present enjoyed by members of the symphony orchestra will all be whittled down to the pay of a solitary individual. It may well be asked why things could not be simplified by simply making one solitary record of the whole orchestra in action.

If this were done, there would be only one interpretation of any given musical work. By having separate records of each instrument, however, the master-mixer will be able to give a fresh interpretation each time a piece is played just as the mood of the moment takes him.

CURRENT TOPICS

EVENTS OF THE WEEK IN BRIEF REVIEW

In Praise of England

THE French journal, *Petit Radio*, pays some pretty compliments to the British Customs authorities in drawing attention to their helpful attitude in dealing with foreign visitors who take their portable receivers with them. A visitor, provided he declares his apparatus to the Customs officer at the port of entry, is exempted from duty as an act of grace.

On the other hand, the visitor to France who chooses to take a portable with him is called upon to pay fairly heavy duties, which, worse still, are not refunded on leaving the country.

French Anti-interference Campaign

THE corps of experts created by the French P.M.G. has, according to our Paris correspondent, had a busy month during August. No fewer than 10,987 pieces of apparatus causing interference were located, and the owners were in every case "invited" to apply adequate suppressive measures.

As most readers are aware, such "invitations" carry more weight in France than in this country; there, the creation of avoidable interference is an offence against the law.

M. Mandel, the P.M.G., evidently means business, as during August nine persons who ignored the "invitation" of his sleuths have received more pressing summonses to attend the local courts.

Neck and Neck

A HIGH authority in German broadcasting circles has expressed an opinion that by 1936 the number of licensed listeners would reach the eight million

mark. Meanwhile, England still leads, as, according to our Berlin correspondent, the total number of German listeners on September 1st amounted to 6,542,168; of these nearly half a million own free licences.

Berlin Exhibition Success

DURING its "run" of thirteen days, 480,000 visitors passed the turnstiles of the German Radio Exhibition. This represents an increase of 60 per cent. over last year, when the Exhibition was open for the same period.

Northern Ireland Amateurs

THE Radio Society of Northern Ireland will hold a transmitting contest for the Leonard Trophy during the week-ends of 26th, 27th October and 2nd, 3rd November from 00.00 hours on Saturday to 24.00 hours (G.M.T.) on Sunday. The contest will be open to all licensed transmitting amateurs in Ireland.

In conjunction will be held a transmitting contest open to British and foreign amateurs, who are required to make contact with the maximum number of Irish stations (GI and EI).

Contacts will be made on the 20- and 40-metre amateur bands. Entries will be welcomed, and any further particulars may be had from the hon. secretary, M. J. Cown (GI5OY), 74, Wheatfield Crescent, Crumlin Road, Belfast.

Heilsberg Improvements

WORK on the Heilsberg station has now been completed, and operation is being carried out with a power of 100 kW., feeding a Lorenz anti-fading aerial. The alterations



"Baby Grand" A novel design for a radio outfit seen at the Paris Radio Show.

have, it is stated, brought about the desired results, and good signals are now obtainable in many areas in East Prussia which were previously considered to be blind spots.

French Procedure

A CIRCULAR just issued by M. Langeron, the Paris Prefect of Police, to his subordinates contains a paragraph to the effect that a policeman on his beat, when asked by a householder to officially report the fact that a disturbance is being caused by a neighbour's loud speaker, must at once report the matter to the nearest police station. Thereupon another policeman will at once be dispatched to the complainant's residence, where he will investigate the trouble and decide whether the complaint is well founded. If necessary, he will take evidence from the neighbours on the spot. While congratulating the Prefect on his energy, the Paris Press expresses strong disapproval of these police visits to private houses.

The Manchester Exhibition

AT the Northern National Radio Exhibition, which opens at Manchester City Hall to-day, Lancashire will be given a chance to supply future radio stars. Special arrangements have been made for giving auditions to would-be artistes, who will perform unseen—but before real audiences. The organisers of the exhibition hope in this

way to stage a well-balanced variety programme.

Intending visitors will be reassured to hear that a preliminary audition will decide the suitability of candidates to take part in the public test.

At Bristol

THE Bristol Radio Exhibition opens next Monday, September 23rd, and closes on Saturday, September 28th. The Show is to be held at the Coliseum, Park Road.

A Book of Circuits

UNDER the title of "Radio Progress," the firm of A. F. Bulgin and Co., Ltd., of Abbey Road, Barking, have issued a useful publication containing not only circuit diagrams, but instructions for building ten distinct receivers, amplifiers, etc. Practical wiring plans are given.

The apparatus dealt with covers many diverse tastes and requirements. Two all-wave AC-DC superheterodynes, one with a single IF stage and the other with two stages, are the most ambitious receivers, while at the other end of the scale we have a simple HF-det.-LF battery set and a "midget" portable. An AC amplifier rated at 10 watts and a DC instrument giving 5 watts are described; the latter employs push-pull pentodes in the output stage. Circuits for battery- and mains-operated short-wave converters are also given.

"Radio Progress" costs 1s., post free.

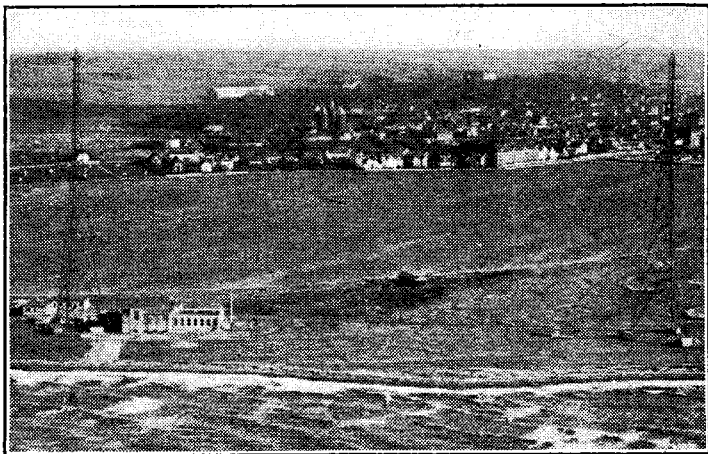

Keeping the sea waves from the wireless waves. An embankment is to be built to protect the Kalundborg transmitter from encroachment by the sea.

LOCATING WRECKS

How Depth-sounding Apparatus is Used at Sea

A DESCRIPTION of some present-day methods of searching for sunken ships or mapping the sea-bed is topical in view of current news of attempts now being made off the Irish coast to locate the wreck of the "Lusitania."

IF a vibration is set up in water, waves are formed which are propagated at the rate of approximately 800 fathoms a second and will be echoed back from any solid matter encountered, such as the bottom of the sea. Waves may be produced from vibrations of different frequencies and can be within the audible frequency range or above or below it. The principle of echo sounding devices is to transmit vertically from an exploring vessel vibrations which are propagated through the water and reflected from the sea bottom, and by calculating the time taken for the return echo to reach the vessel the distance travelled can be accurately arrived at.

In this way, by the transmission of a succession of waves, it is possible to ascertain the varying depth of the sea bottom as an exploring vessel proceeds on the surface, and to detect the presence of any unusual variation of depth such as would be indicated by the presence of a wreck.

The general principle of depth-sounding has been

known for a considerable time, but practical apparatus has been developed in different forms. In the simplest form the hull of a ship can be struck with a hammer and the echo listened for with a Hydrophone, or similar type of receiver. In developing apparatus it has been found that if waves of the frequency of sound are produced propagation takes place spherically and has practically no directional properties, but waves of a frequency above audibility which can be produced by electrical means can be made highly directional, with the advantage that they can be propagated vertically to the bottom of the sea as a focused beam, and the echo returns without undue wastage of energy.

In some forms of the apparatus the projector for the sound

waves fitted to the hull of the vessel can also act as the receiver. By electrical means the projector (Fig. 1) is caused to produce mechanical oscillations momentarily, and when the echo returns the same apparatus converts the mechanical oscillations set up into electrical energy which can be amplified by means of valve amplifiers. The projector is fitted to the hull of the ship flush with the hull plates and is horizontally positioned so that the waves are directed vertically downwards.

A simple formula from which the depth can be calculated is $d = Vt/2$ where d is the depth, V is the speed of propagation in water of the vibrations, and t the time separating the moment of transmission from the moment of reception of

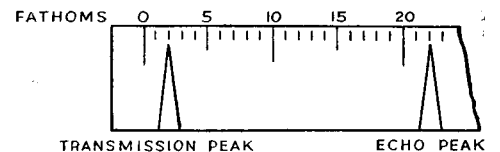

Fig. 2.—The depth in fathoms of the sea-bed or any intervening object is calculated on the calibrated scale by the distance between the transmission and echo peaks.

the echo. Soundings are taken by transmitting and receiving brief ultra-sonic signals and measuring the echo periods. The echo periods are naturally very short because of the comparatively high speed at which the waves travel in sea water. One "echo period" takes place in $1/2450$ th part of a second.

In the Marconi sounding equipment the echo periods are measured in conjunction with a special chronometer, so that the depths of the soundings can be read directly. The operator has not a very complicated task to perform. He has merely to watch a spot of light on the scale of the instrument, which is calibrated directly in fathoms; the spot of light travels along this scale until it reaches a point where it produces a peak on the scale which is at the precise depth of water under his ship (see Fig. 2). With a little experience the nature of the bottom, whether hard or soft, rough or

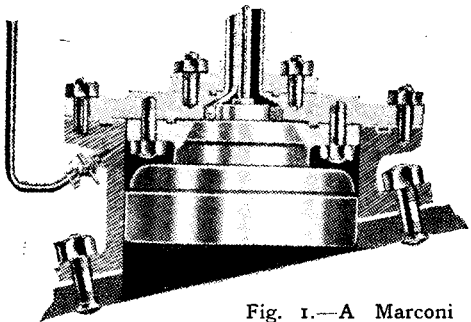

Fig. 1.—A Marconi sound-wave projector for fitting to the hull of a ship.



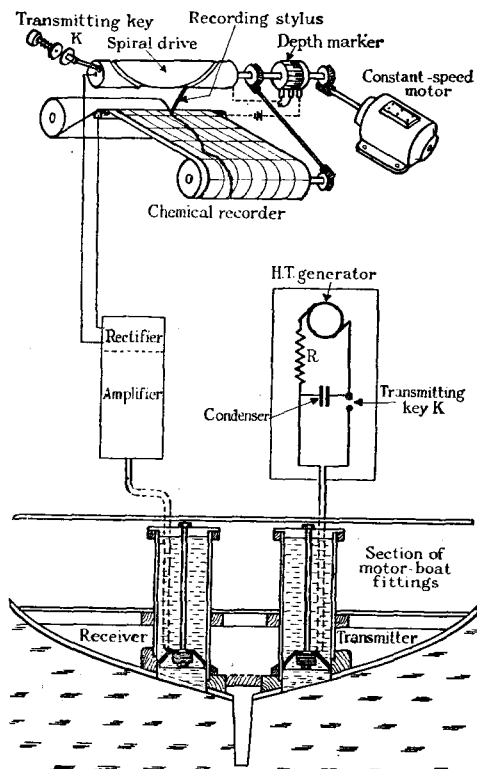

Fig. 3.—The principles of a system that gives a permanent record of the contour of the sea-bed. (Courtesy I.E.E.)

smooth, can be deduced from the shape of these echo peaks. There are different instruments designed by the Marconi Company which are suited for surveying in different depths.

Another type of instrument based on the Admiralty magnetostriction system is manufactured by Messrs. Henry Hughes and Son, Ltd. This instrument, the principle of which is shown in Fig. 3, has the characteristic that permanent records are made, the actual recorder consisting of a pen operating on a moving drum which

carries paper chemically treated so as to imprint on the paper a mark when electrical current flows between the point of the pen and the metal drum of the recorder. An actual record of the contour of the sea bed is shown in Fig. 4. The instrument operates at a lower frequency than the Marconi type and employs two oscillators, one to transmit and one to receive. Very shallow soundings can be taken as well as soundings to depths as great as 1,200 fathoms with the same instrument.

Where the bed of the sea is soft or sandy in character the records taken with depth sounding apparatus will show a comparatively level or gently undulating contour, whereas in the case of a rocky bed more abrupt changes are to be expected, with deep depressions and rises such as would, in the case of a soft bed, be filled in with the shifting loose nature of the sea bottom.

Depth sounding apparatus has been developed principally as a rapid and more satisfactory substitute for the earlier extremely slow and rather unreliable system of sounding by the lead. The principal object is as an aid to navigation

where there may be risk of a vessel grounding in shallow water.

Recently much attention has been paid to the use of this equipment in connection with salvage work, and we may expect to hear more of its application to the fascinating task of locating and salvaging wrecks. There is always much romance

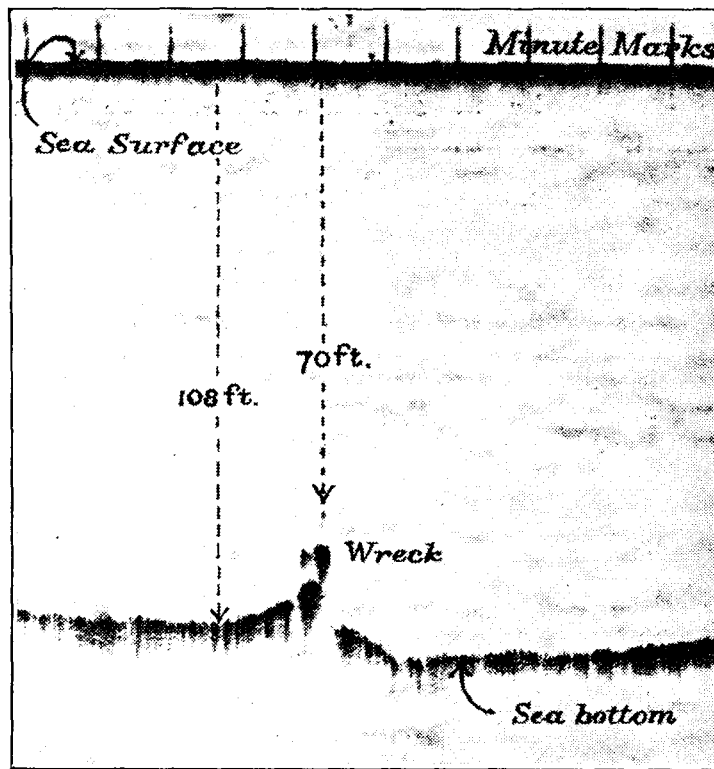

Fig. 5.—How a wreck was located in the River Mersey.

attaching to the possibility of recovering treasure from wrecks of bygone times, and the chances of success attending such efforts are greatly enhanced with the improved efficiency of this apparatus. Readers will be reminded that the efforts at present being made to locate the ill-fated *Lusitania* are being greatly assisted by this means.

It will be realised that an exploring vessel charts only the line of the sea bed directly beneath the course it is following and, therefore, it is necessary to know pretty closely where to search for a wreck before it can be hoped to locate it precisely. If the wreck is on a fairly smooth hard bottom it will be far easier to recognise its presence on the chart than if it lies on a very irregular bed or on a soft bottom where sand has silted up over it and the wreck has itself tended to settle down, but even in such cases it will generally be found that the silting up has taken place mainly in one direction so that an abrupt drop will be observed on the other side of the wreck.

Fig. 5 is a photograph of an actual record taken with the Hughes apparatus which located the precise position in which a vessel sank in the River Mersey. It was located at a depth of 70 feet from the surface.

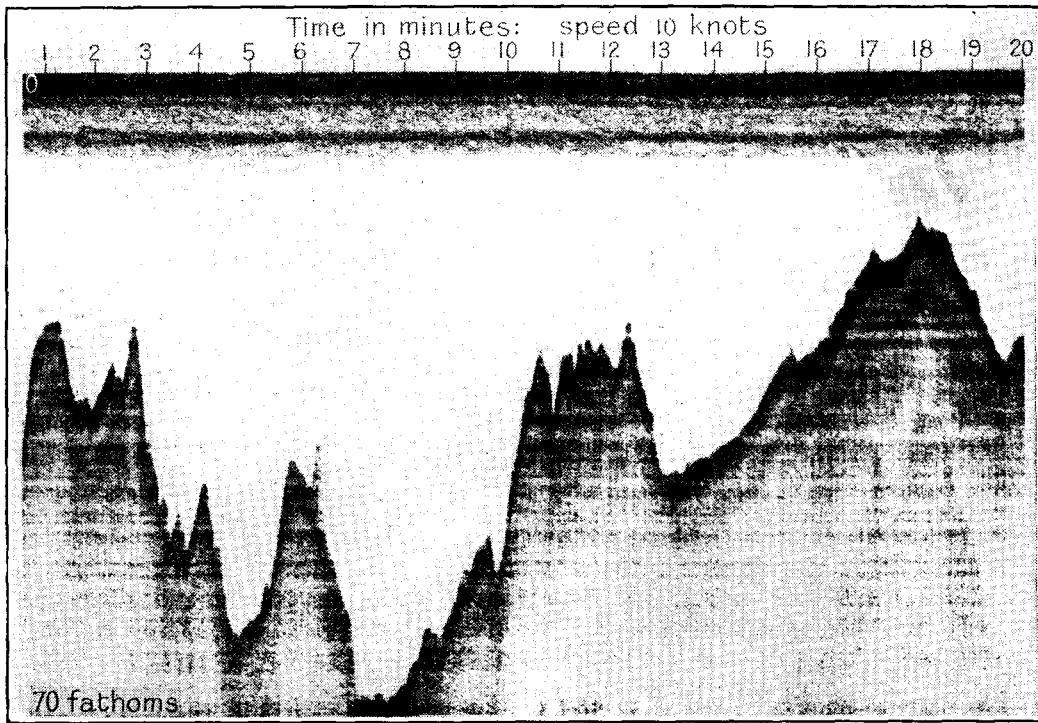

Fig. 4.—A reproduction from an actual record taken by the apparatus suggested in Fig. 3. (Courtesy I.E.E.)

Paris Radio Exhibition

More All-wave Receivers : European Valves Re-established in Favour : Interesting Improvements in Dial Design

By A. AISBERG, Editor, *Toute la Radio*

OLYMPIA, Berlin, and now Paris. By studying this review of the Radio Salon in conjunction with our reports of the earlier Shows, readers will be able to compare the trend of progress here and abroad.

ALTHOUGH a country of 40 million inhabitants, France can only claim to have 2 million licensed broadcast listeners. A comparison with England shows that the market for wireless is far from saturated and that it ought to be possible to increase the number of listeners enormously, even in difficult times. With this end in view the broadcasting organisation is being actively extended. Manufacturers, on their side, are improving the quality of receivers and intensive propaganda is bringing radio to the notice of the public.

The twelfth Radio Salon provides an excellent pretext for this propaganda. If former exhibitions were principally destined to record improvements made during the year, this season's Salon has as its principal object the making of converts to broadcasting. Because of this, the character of the Exhibition is distinctive.

On the total area of 9,000 square metres which the Exhibition occupied under the vast roof of the Grand Palais, 3,000 square metres were devoted to general propaganda, and 4,700 square

metres were occupied by 220 trade stands.

Remarkable success has crowned the efforts of the organisers, headed by M. Robert Tabouis, President of the Exhibition Committee, who has been responsible for every detail. The State Broadcasting Service took part by exhibiting models of transmitters, pictorial statistics, and by organising concerts on a large stage.

The Federation of Private Stations, which includes Poste Parisien, Radio Normandie, Radio Côte d'Azur, etc., also arranged an exhibition of models of their stations and showed reconstructed scenes of a broadcasting station at work, with wax models of the staff.

A stand was devoted to demonstrating the evolution of methods of transmitting messages, showing successively a primitive man carrying a letter written on a

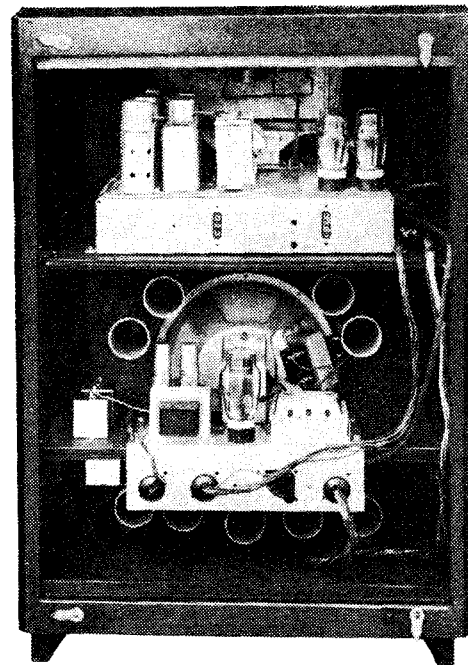

The L.M.T. receiver, as seen from behind. Above, HF, IF and detector stages; below, output stage and mains equipment. (Note the 9 tubes arranged round the loud speaker, with the object of projecting forward the low notes emitted by the back of the loud-speaker diaphragm.)

nical Stabilisation" is more appropriate and indicates to the public that a receiver bought now is not likely to become quickly out of date.

In reality, and perhaps fortunately, the technique of radio never seems to stabilise, and new tendencies could be noted at the Show. The greatest indication of stability was a financial one; receivers cost about the same as last year but quality has been very much improved.

This Exhibition might be described as an all-wave exhibition, because whereas a year ago receivers with short-wave ranges were few, this year they are very numerous and can be found even amongst receivers

priced as low as 1,000 francs.

Except in the case of three-valve receivers comprising HF, detector and LF stages, all the receivers were super-heterodynes, being designed usually on the lines of pre-selector, sometimes first HF amplifier, combined oscillator-detector, one stage IF, diode detector, usually combined with the first LF amplifier stage, and an output LF stage—frequently push-pull.

During the last few years France has been a battleground between two rivals in technique—European and American.

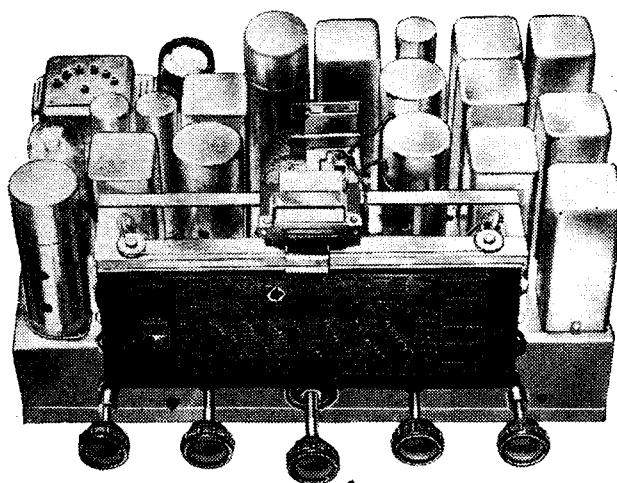

Chassis of the "Mildé" 7-valve receiver using valves of American type. This efficient four-wave range receiver typifies the "American" tendency in French construction.

stone (but in French!), a pre-historic bicycle, a cage with live carrier pigeons, a model of a 1900 car, an aeroplane, and finally a wireless transmitter.

The general appearance of the hall and of the stands was very attractive. A central amplifier provided a common supply to loud speakers installed in different parts of the hall and to the loud speakers of receivers on the stands.

Each year it has been customary to adopt some slogan for the Exhibition. In 1934 the slogan was "A Cheaper Radio Show." This year the slogan "Tech-

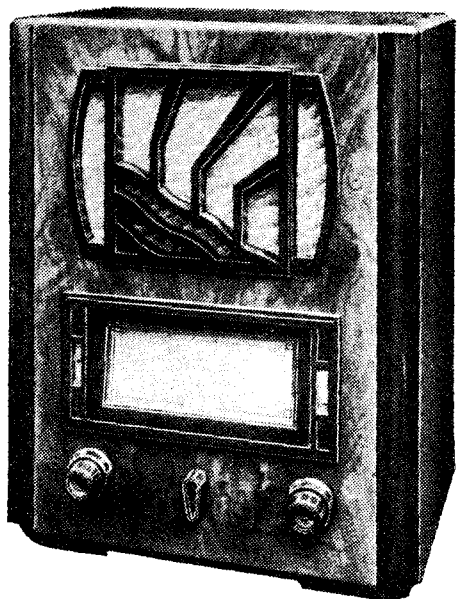

Multi-inductance receiver Radiola 567, with a similar circuit to the Philips 535. It is a receiver which demonstrates the "European" tendency in French design.

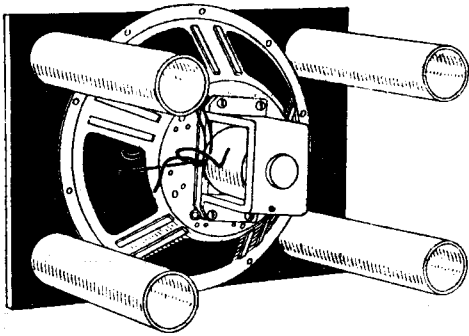

Arrangement of the "harmony tubes" on the baffle of the L.M.T. loud speaker.

The mass importation of valves made in U.S.A. and their relatively low price encouraged a number of designers to adopt American circuits and then, in spite of measures taken to reduce the importation of American valves, they continued to be used very largely, either of direct American origin or manufactured in France. Of less sensitive characteristics than European valves, American valves necessitate the employment of a larger total number for a given performance of a receiver. To-day the battle appears to have been won by the European valve, and the victory has no doubt been brought about by the standardisation agreed upon by the principal Continental makes (Philips, Telefunken, Radio Technique, Valvo, Tungram, etc.), all of which now produce under the same type number, valves with similar characteristics. The price of valves has undergone a substantial reduction and their general reliability has improved.

The new European valves which have replaced the American ones are fitted with standard bases with side contacts. Frequency changing is now done with European octodes in place of the American heptodes.

Types of Receiver

The French receivers are all required to be suitable for alternating current of 25 or 50 cycles at either 100 or 220 volts, but a number of models are available in universal AC/DC form.

Car radio sets, of which some interesting models were shown, are often of the universal type and are applicable for use either with a 6-volt car battery with a rotary converter or vibrator, or else for the mains supply in the user's home. As

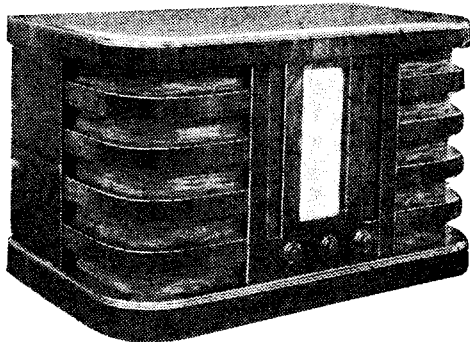

An unusual style of cabinet; the receiver is a nine-valve superheterodyne fitted with twin loud speakers.

has already been mentioned, all-wave receivers are in the majority to-day and short waves can be received with practically the same facility and nearly the same stability as normal wavelengths. In many cases there is a pre-detector HF stage providing amplification on all wavelengths.

The problem of providing all-wave tuning is usually solved by employing separate coils for each wavelength and putting these in circuit by means of a multi-way, multi-position switch, and the French radio industry has rather specialised in the design of low-loss switches for this purpose. Each coil is sometimes separately shielded, as, for example, in the multi-inductance system introduced by Radiola and Philips.

Some makers employ a different arrangement, either double frequency changing for the short waves or the employment of two separate channels for frequency changing, one for the normal wavelength and

Variable selectivity represents for France a particularly important improvement, because the transmitting stations are installed in large towns, Paris having, for example, no fewer than five transmitters. Therefore, to receive transmissions from abroad, receivers must nor-

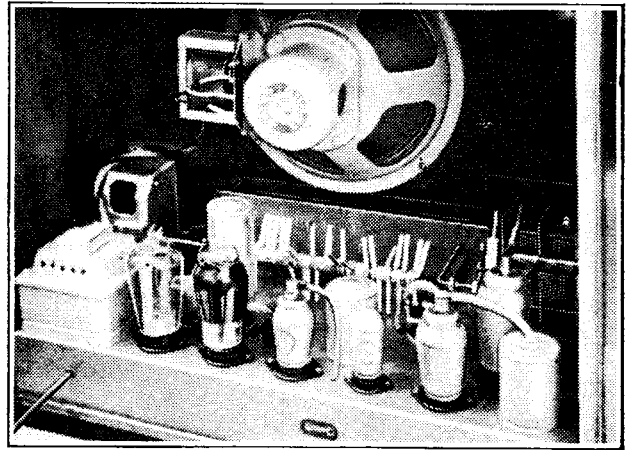

"Supervia" receiver, with automatic push-button tuning.

mally possess such a high degree of selectivity that quality is impaired. The ability to broaden the frequency band received at will for the reception of local or strong transmitters is accordingly a most important progressive step.

Detection is usually by means of a diode, and the importance of avoiding distortion in the LF stage is now receiving much more attention in France. This year the general tendency is towards increasing the output from receivers, and 3 watts is now regarded as almost a minimum, some of the larger receivers having an

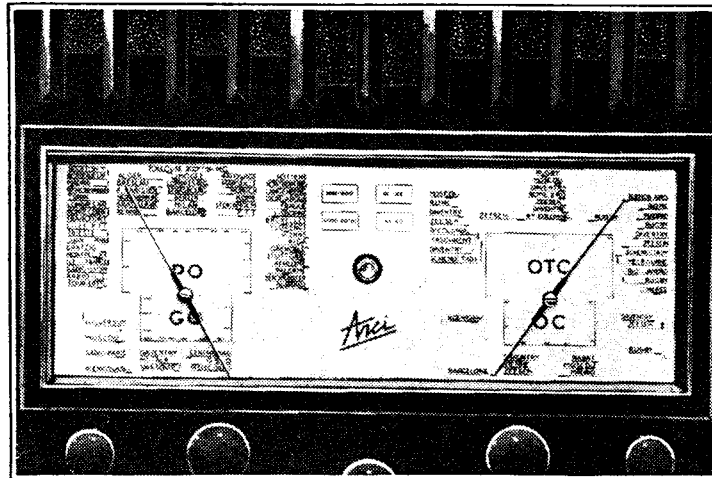

Arci receiver with four wave-ranges, including the short and ultra-short bands. This receiver is arranged with two independent ganged condensers.

the other for the short wavelength range; in particular, we should mention in this connection the Arci receiver, which comprises two separate triple variable condensers and employs a double dial, of which one part deals with the medium and long waves and the other the short waves. Most of the short-wave receivers are fitted with a two-speed dial.

As in other countries, the French technicians have turned their attention to the problem of high fidelity and substantial progress has been made during the past year. Variable selectivity has been introduced into high-class receivers, the control of selectivity being made in most cases by varying IF coupling.

This is controlled either by a rigid rod or by a Bowden wire; and in a few cases it is done by varying capacity coupling, in which case precautions have to be taken to compensate for detuning.

output of as much as 12 watts, with a consequent substantial increase in the possibilities of good quality as compared with the former French sets of small output.

The Paris Exhibition shows some of

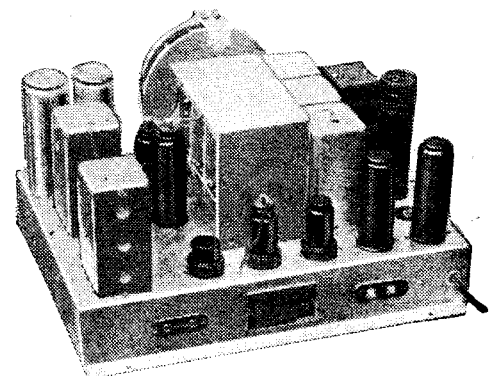

"Air King" receiver, imported from America and equipped with the new all-metal valves.

Paris Radio Exhibition.—

the first French examples of receivers with two or more loud speakers, and improvements have also been made in the loud speakers themselves. The L.M.T. firm exhibited speakers where from two to nine tubes are fitted through the baffle; the purpose of these is to project forward low-frequency waves created by the back surface of the diaphragm.

Medium and high notes projected by the back surface are absorbed by a felt lining on the interior of the cabinet, and, according to L.M.T. designers, the intensity of low notes is increased because those projected by the back of the diaphragm are added to those projected by the front. This reasoning hardly appears to take into account the problem of phasing between the two sound-waves, but whatever the explanation may be, a very good impression of natural reproduction is obtained in listening to this speaker.

One manufacturer showed a loud speaker with an exponential diaphragm, in the centre of which is placed a small spherical diaphragm intended to reinforce the high notes by creating behind it a highly damped resonant chamber.

Great attention has been paid this year to external appearances, and a good many receivers have been designed with the loud speaker at the side, as a change from the usual vertical arrangement. It may be noted, too, that the desk type of receiver has reappeared, with a tuning dial remarkably convenient to operate.

Tuning dials have come in for considerable attention, and nearly all dials are of the full-vision type, and quite a number follow American practice and are of the "aeroplane" style. Others are rectangular, marked with names of stations and wavelengths, and with changing illumination to indicate the range of wavelengths on which the receiver is working. Most receivers now adopt some type of tuning indicator; the commonest is a milliammeter, but there are one or two examples of the neon tube.

The Philips *de Luxe* receiver 536 is so arranged that the pointer of the dial serves at the same time as a tuning indicator, the pointer consisting of a little luminous four-pointed star, maximum illumination of which indicates precise tuning. The little lamp which projects the luminous star is fed by a special transformer, one of the windings of which is in series with the anode circuit of a valve controlled by the AVC system. This current normally saturates the iron of the transformer and it is only when it is reduced under the in-

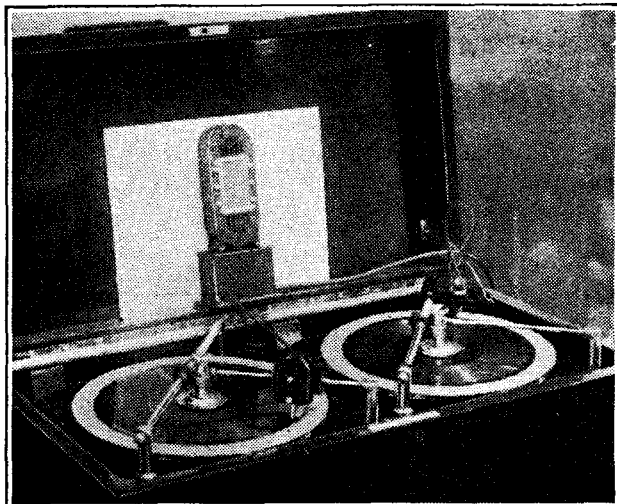

Combination gramophone recorder-reproducer "Mellographe-Marina." On the right is placed the cutting pick-up and on the left the reproducer. The microphone is behind.

fluence of AVC that the iron ceases to be saturated and allows the light to receive sufficient voltage to light up to its full brilliance.

As an exception, the Arci receiver already mentioned has no tuning indicator; instead it is fitted with an arrangement which ensures precise tuning automatically. It is only necessary to tune this receiver approximately to the desired station when a little relay, operated mechanically by the current of a valve regulated by AVC, adjusts the capacity of auxiliary trimmers until the precise tuning is obtained.

Then the very unusual "Supervia"

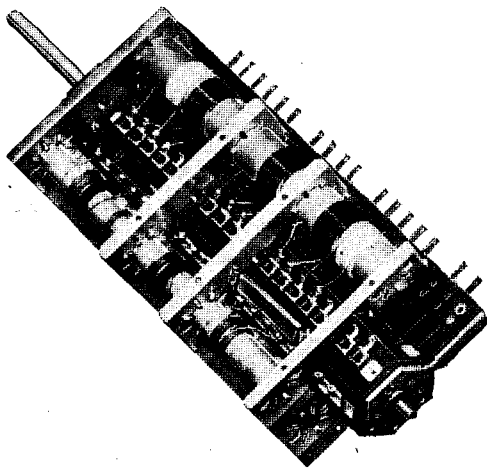

Exterior of a Gamma coil unit (screening removed) for three wave ranges, with built-in switching mechanism. Each range comprises coils for pre-selector, coupling transformer for the HF stage and oscillator coils.

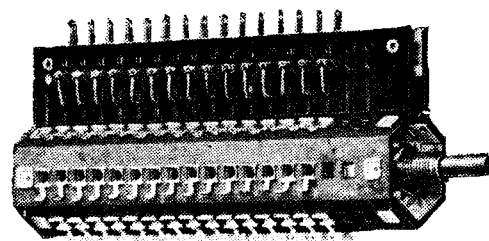

Gamma switch with 15 poles and six positions.

receiver, with automatic tuning to 45 stations, should be mentioned. Forty-five buttons appear on the front of the receiver, and when any one of these buttons is pressed the receiver proceeds to tune itself to the station to which the button corresponds. The mechanism is ingenious but quite simple; the variable condenser, rotated by a small motor, has an extension of its spindle which carries 45 adjustable arms. The pressing of the appropriate button causes a stop to project with which one of these arms engages, so that rotation of the condenser vanes is checked at the exact position corresponding to resonance with the desired station. Current supply to the motor is then interrupted, and the valve anode circuits are completed.

Finally, it may be mentioned that the Paris Exhibition, like Olympia, ignored television, exhibitors having been warned to avoid diverting the attention of the public to this subject.

THE RADIO INDUSTRY

It is understood that Scopphony, Ltd., has granted to the German Tekade firm a licence to use, manufacture, and exploit in Germany television apparatus incorporating the direct-viewing mirror screw. Apart from this it seems likely that closer co-operation in other directions is to exist between the two companies.

The Copper Development Association, of Thames House, Millbank, London, S.W.1, have published, under the title of "Copper Data," an attractively produced and extremely informative pocket book which contains all the generalised information about copper which the ordinary user is likely to need. This is one of the "Engineer's Note Book" series issued by the Association, which will be pleased to send copies to readers free of charge.

We have now received a copy of the 1936 edition of the "All Metal Way" from Westinghouse Brake and Saxby Signal Co., Ltd., 82, York Road, King's Cross, London, N.1. This useful publication has been revised in conformity with recent developments, and a considerable amount of space is devoted to the Westector and its uses. Information is also given on the high-voltage metal rectifier for television work. Copies are obtainable for 3d. post free.

Two New Dynatron Sets

THE "Toreador" table model console and "Ether Challenger" radio-gramophone, hitherto available for AC mains only, are now obtainable with a universal AC/DC chassis as an alternative. The "straight" circuit with two HF stages is essentially the same as that of the AC model and includes AVC. Prices are as follow: Model TU63 (table-model), 16 guineas; Model CU63 (radio-gram.), 27 guineas. Readers in the north will have an opportunity of examining the new sets at the Manchester Show.

Television Experiments

A High-definition Test Transmitter

By J. H. REYNER, B.Sc., A.M.I.E.E.

IN order to obtain reliable data on the design of television equipment I decided a short while ago to build a high-definition test transmitter. Some experience had already been gained on a 30-line transmitter which was designed for some demonstrations in Manchester, as reported in *The Wireless World* of May 31st last.

The main problem was that of scanning. For simplicity the subject matter was provided by a film, but the production of a scanning disc or mirror drum for 120 to 180 lines is a matter requiring a very high degree of engineering skill. It was therefore decided to use a cathode-ray tube for the scanning. By focusing the spot on to the film by means of a suitable lens system, and causing the spot to sweep over the screen in the usual scanning movement, the film itself can be scanned, and a photocell placed immediately behind it will convert the light impulses into electric currents.

The difficulty is to obtain enough light, but after some experiment the use of a Cossor type 3273 tube was found to fulfil the requirements. This is a hard tube having 6,000 volts on the main anode. The screen is of the J type giving



A long shot at an exterior. A considerable improvement in picture value is apparent when seen as a moving image.

an actinic blue glow very suitable for photocell work, and having a negligible afterglow, which is exceedingly important.

The output from the photocell was amplified in a specially constructed 7-stage amplifier having a flat response up to one megacycle and giving an output of 30 volts peak. The photocell stage, however, introduces high frequency loss due to the high anode resistance which has to be employed, and correcting circuits are inserted to compensate for this. At pre-

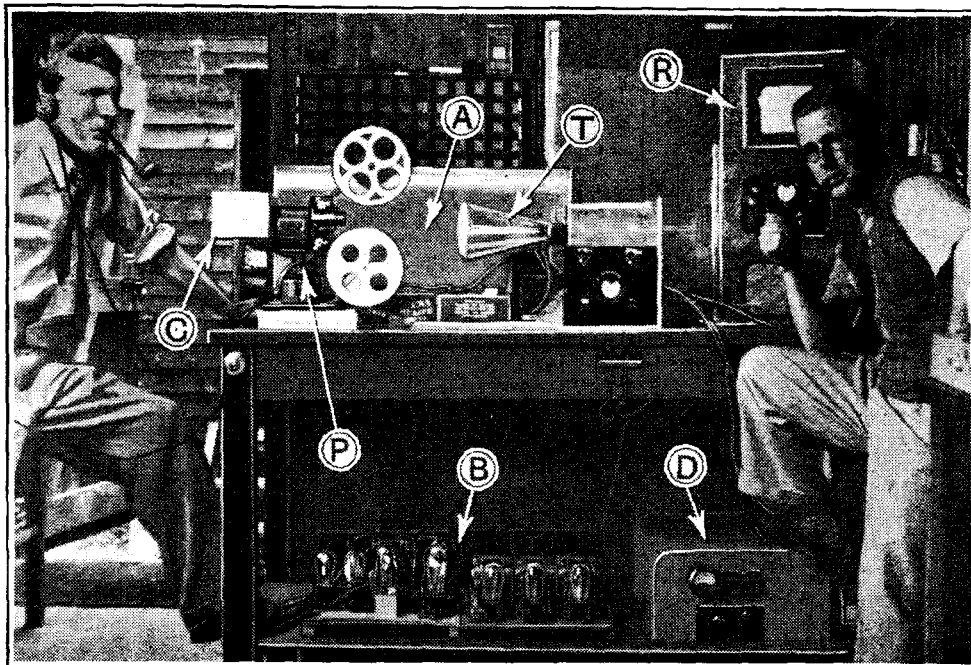

The complete equipment, comprising A, main amplifier; B, transmitter time bases; C, photocell; D, 6,000-volt power unit; T, transmitter tube; P, projector; and R, receiver.

sent, for reasons explained later, this correction only extends to about 350 kc., so that the full range of the amplifier is not used. An Oxford vacuum cell is employed.

Ediswan type AH receiving tubes are used, giving a picture some 6in. by 5in. of a pleasing and quite brilliant black and white. These operate off 2,500 volts and can be fully scanned with a time base voltage of about 400, while the output from the amplifier is more than sufficient to provide full modulation.

Up to 180 lines have been used, but for ordinary purposes about 120-line transmission is usually employed. The system is, of course, particularly flexible in that the number of lines can be altered at will, and excellent pictures are obtained with 120 lines only. By the use of suitable film a variety of subjects can be transmitted, ranging from cartoons, which test the low- and high-frequency response at the same time, to various types of half-



A direct photograph on the receiving tube. The exposure was of 6 seconds duration.

tone covering both flat and contrasting subjects.

The results have already shown that the design of successful amplifiers does not only involve adequate frequency response, and the transmission of delicate half-tones instead of the soot-and-whitewash effects so prevalent with 30-line television has provided an interesting study and useful data.

The centre photograph illustrates the complete assembly comprising transmitter tube, projector for focusing the raster on to the film and passing the light into the photocell, video-frequency amplifier and monitor receiving set. The film is run through the projector in the usual

way, giving moving pictures or "stills" at will. The projector is synchronised with the picture-frequency time base.

The other illustrations are two "stills" photographed direct from the receiving tube. The exposures were 6 seconds each, which gives an idea of the steadiness of the image. The close-up illustrates the excellent half-tones which can be obtained, while the other shot is an attempt to show how scenes involving several relatively small figures can be transmitted. The effect of movement in a shot of this character, of course, considerably improves the apparent detail.

A duplicate of the apparatus has been built in portable form, and it is hoped that this will be on view in various parts of the country during the coming months. In particular it is being demonstrated at a radio exhibition at Messrs. Bentalls, of Kingston, until September 21st, and at the Kettering Radio Society's exhibition from September 26th to 28th.

Listeners' Guide for

Outstanding Broadcasts at Home and Abroad



Marie Wilson, who is solo violinist and leads the B.B.C. Symphony Orchestra in the Bach Promenade Concert which will be relayed Nationally from the Queen's Hall on Wednesday.

forte recitals during the week, the former in the National programme on Wednesday, and the latter in the Regional programme on Thursday.

FROM THE LONDON STREETS

A PROGRAMME of uncommon interest under the above title, devised by Cecil Madden, will be given at 7.40 in the National programme on Saturday. All the artistes who will appear on this occasion are authentic street musicians in London. Many listeners will have heard the brave music of ex-Pipe-Major Massie, a familiar figure in Trafalgar Square, and among others appearing will be Billie and Nick Goodwood, the former possessing a natural tenor voice of extraordinary power, Harry Astley, who accompanies a mechanical organ with spoons, and is renowned as one of the masters of the strenuous and exacting art of "spoon bashing," and John Snuggs ("The Troubadour"). The programme will be presented by Mr. S. E. Reynolds, whose hobby it is to meet and befriend these stars of the pavement and the pit queue.

RECITALS

MADAME BLANCHE MARCHESI, the famous singer and teacher, will make her broadcasting debut with a recital in the Regional programme on Sunday at 9.30.

Madame Marchesi comes of an old Sicilian family, and both her parents were noted singers, studying under the famous Manuel Garcia, teacher of Jenny Lind.

Following this item in the same programme Antonia Butler will be giving a violoncello recital.

A harpsichord recital on Monday will be given Nationally by Ernest Lush.

Edward Mitchell and William Murdoch will each give piano

COVENT GARDEN RELAY

FROM the Royal Opera House, Covent Garden, on Monday, in the National programme at 8.30 and 10.30 comes Delius's "Koanga" preceded by an explanatory introduction. Frederick Delius (1863-1934) was one of the most remarkable composers of his time, coming of German parents who had settled in England. At the age of twenty he ran away, due to his dislike for business, and established himself as an orange planter in Florida where he devoted his leisure to the study of music. In 1896 he wrote his first opera, "Koanga," the libretto of which was taken from "The Grandissimes," the novel by C. F. Keary and G. W. Cable. It deals largely with negro life, and shows the influence of the tropical luxuriance of Florida on his work.

The title rôle is taken by

The Pavilion, Bournemouth, from which the Municipal Orchestra, conducted by Richard Austin frequently broadcasts.



John Brownlee, and the London Philharmonic Orchestra will be conducted by Sir Thomas Beecham.

HIGH SPEED

PEGGY COCHRANE appears in the Regional programme on Monday at 9.25 in "A Tune a Minute." From the title I think one can expect something really snappy.

STILL INCREASING

ANONA WINN will be back at Broadcasting House in the Regional programme on Tuesday next when she will be at the head of her still increasing "Winners," who now number seven in addition to herself.

"PURITAN LULLABY"

THE love story of Miles Standish, leader of a Puritan community in the early days of the colonisation of America, has been a favourite theme with writers of all kinds from Longfellow onwards. Last year James Dyrenforth turned the story into a light operetta complete with a chorus of Indians who speak in the metre of Longfellow's immortal "Hiawatha."

This charming little play, "Puritan Lullaby," is being revived on Tuesday (National) and Wednesday (Regional) to satisfy the demands of its many admirers. As will be

FRIDAY, SEPTEMBER 20th.

Nat., 7.30, Thirty Syncopated Minutes. 8, "Within the Law." Reg., 8, Promenade Concert. 9.40, Recital of pianoforte duets.

Abroad.

Brussels No. 2, 8, Radio Orchestra from the Exhibition studio.

SATURDAY, SEPTEMBER 21st.

Nat., 7, Fred Hartley and his Novelty Quintet. 7.40, "From the London Streets." 8, Promenade Concert.

Reg., 8, Jack Hylton's Radio Revue. 9, "Farewell to Summer": a programme to mark the passing of summer.

Abroad.

Paris P.T.T., 8.30, Cabaret.

SUNDAY, SEPTEMBER 22nd.

Nat., Albert Sandler and the Park Lane Hotel Orchestra.

Reg., B.B.C. Theatre Orchestra. 9, Melodies of Christendom—18 (B.B.C. Singers). ♪Soprano and Violoncello Recitals.

Abroad.

Brussels No. 2, 8, Symphony Orchestra.

MONDAY, SEPTEMBER 23rd.

Nat., Harpsichord Recital, Ernest Lush. ♪"Koanga," from the Royal Opera House, Covent Garden.

Reg., Medvedeff's Balalaika Orchestra. 8, Victorian Melodies—No. IV: B.B.C. Men's Chorus and Theatre Orchestra. ♪Variety.

Abroad.

Leipzig, 8.10, "Norma" (Bellini).

TUESDAY, SEPTEMBER 24th.

Nat., "Puritan Lullaby." ♪"Night Falls in Budapest." ♪Leslie Bridgewater Harp Quintet.

Reg., Victor Olof Sextet. 8, Mozart Promenade Concert. ♪Anona Winn and her "Winners."

Abroad.

Paris P.T.T., 8.30, Band of the

Garde Républicaine.

All German stations, 8.15, "The Speedier Ship": a radio drama.

WEDNESDAY, SEPTEMBER 25th.

Nat., Alfredo Campoli Trio in "Ballads of Yesterday." 8, Bach Promenade Concert. ♪"Night Falls in Budapest."

Reg., "Puritan Lullaby." 8.45, B.B.C. Military Band with Tudor Davies (tenor).

Abroad.

Strasbourg 8.30, "L'Ombre"—three-act opéra-comique (Flotow).

THURSDAY, SEPTEMBER 26th.

Nat., "The Street Singer." ♪"Baffles—The Amateur Batsman." 9, "The Use of Man" (Lord Dunsany).

Reg., B.B.C. Dance Orchestra. 8, Sibelius Promenade Concert.

Abroad.

Deutschlandsender and Stuttgart, 8.10, Little-known Overtures.

the Week

remembered, it is cast in the form of a bedtime story related by a present-day mother to her small son, and the child's comments on the action and characters are not the least amusing feature of the play. The music has been composed by Kenneth Leslie-Smith, and the B.B.C. Theatre Orchestra and Revue Chorus will be conducted by Stanford Robinson. The part of Miles Standish will be taken by George Baker, and also included in the cast will be Natalie Hall, Stuart Robertson, and Webster Booth. Peter Cresswell will be the producer.

ON THE DANUBE

FROM Budapest on Tuesday and Wednesday in the National programmes at 10.10 come by landline the first and second episodes of "Night Falls in Budapest," arranged on the spot by Eric Maschwitz.



Madame Blanche Marchesi, who will be making her radio debut in the Regional programme on Sunday.

In order to make the relays intelligible to British listeners a small English cast will be recruited and will attend the ceremonies, and visit the cafés and productions from which relays are being taken. British listeners will hear this cast interpreting the scenes. Frances Clare will play the part of the English girl visitor accompanied by a young Englishman, who are being shown the sights of the city on the Danube by two young Hungarians who are out to give their friends a good time.

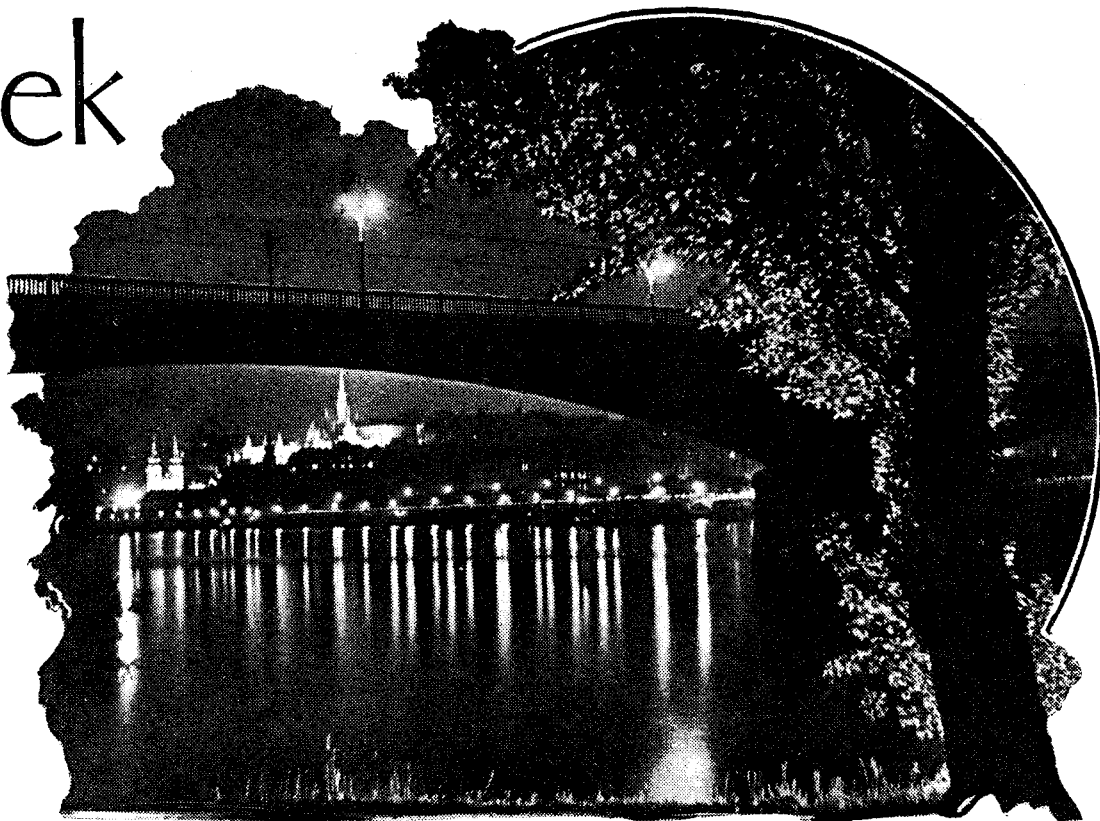

An impressive view of the city on the Danube from which will be relayed this week the first and second episodes of "Night Falls in Budapest."

CROOK AND CRICKETER

IN the National programme on Thursday will be found "Baffles—The Amateur Batsman," by John Dighton, with apologies to the late E. W. Hornung's immortal creation. The producer of this little farce will be Max Kester, and among the cast will be Bobbie Comber in the rôle of L.B.W. Baffles (crook and cricketer), and Claude Dampier as Habbit Warren (his friend).

THE STREET SINGER

THE inimitable Arthur Tracey, better known as "The Street Singer," will be introduced into the National programme on Thursday at 8 o'clock by James Dyrenforth. This well-known American will be giving a fifteen-minute entertainment accompanied by the B.B.C. Variety Orchestra.

NATIONAL AND FOLK MUSIC

THERE are several programmes under this heading which are of outstanding interest. On Sunday Warsaw broadcasts a Polish folk programme from Lwow entitled, "A Wedding in Podhale," a particular attraction to everybody to whom folk customs make an appeal.

On the same day at 5.30 Munich relays a village festival from the well-wooded mountainous regions between Munich

and Lindau. The programme includes musical nursery rhymes of great antiquity performed by a children's choir.

The music of Iceland, interpreted by the famous Reykjavik Male Voice Choir and Miss Elsa Sigfuss, will be relayed from the studio at Copenhagen on Wednesday at 9.15.

On Thursday the Deutschlandsender and Leipzig will be radiating at 7 a programme of folk music of the German communities abroad.

CONCERTS

AN important concert for lovers of the music of Johann Strauss is to be given from Cologne on Saturday at 8.10 by the Cologne Male Voice Choir with the augmented Station Orchestra, conducted by Peter Weber. Sunday provides the only Open-air Concert of the week, when a Regimental Band, under the leadership of Heins Michalowski, playing in the Adolf-Hitler Platz, Tilsit, will be relayed by Königsberg (12 noon).

OPERA

FROM Vienna to-night (Friday) at 7.30 comes Bellini's "I Puritani" (The Puritans), an opera which contains some of the brightest and most melodious of this composer's works. It is always interesting to English audiences since the

action takes place in England during the struggle between the Cavaliers and Roundheads (or Puritans, as Count Pepoli, author of the libretto, calls them). The Vienna State Opera Choir and Vienna Symphony Orchestra, conducted by Kabasta, will be supporting a distinguished cast.

On Monday Leipzig celebrates the centenary of Bellini's death by the performance of his two-act opera "Norma" at 8.10.

OPERETTA

SATURDAY finds Lehár even more popular than usual, with two almost simultaneous broadcasts of his operettas; Prague is relaying a performance of "Where the Lark Sings" from Bratislava (8.15), while at 8.35 his "Land of Smiles" will be heard from Sottens. On the same evening Radio-Paris gives us a musical treat—for those of us at least who enjoy humorous music—in the shape of "Le Sire de Vergy"—Terrasse.

ENGLISH MUSIC

ONE hour's classical and modern English music will be given from the Swedish transmitters on Monday at 7.30 featuring the singer Glyn Eastman with Anita Harrison at the piano.

THE AUDITOR.

Thyratrons

The Grid-controlled Rectifier Simply Explained

By J. E. M. COOMBES, B.Sc.

AMONG the many uses of the thyratron¹ in industry may be mentioned the speed and voltage regulation of motors and generators, the control of automatic arc welding apparatus, and, in conjunction with photo-electric cells, the counting and timing of a great variety of mechanical operations. An application which has interesting possibilities is the conversion of DC to AC at an efficiency approaching 99 per cent. without the need for any mechanically moving parts.² In the present article it is proposed to discuss the working of the thyratron in simple terms, and to lead up to an explanation of its use to produce "saw-tooth" voltage wave-forms for application to cathode ray oscillographs and television receivers.

The thyratron (from the Greek word meaning "a door") is a three-electrode tube similar to the ordinary thermionic valve, into which, after exhaustion, a small

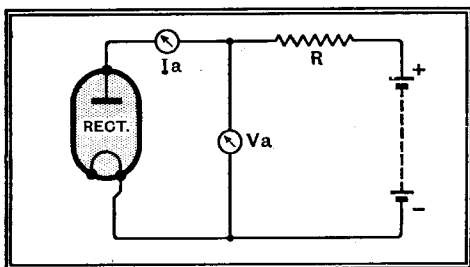

Fig. 1.—Circuit for finding the anode voltage/anode current characteristic of a mercury vapour half-wave rectifier.

quantity of inert gas or vapour has been introduced. Mercury is commonly employed for this purpose, but helium and neon are preferable for frequencies of operation greater than 1,000 c/s. The presence of the mercury vapour changes the pure electronic discharge of the thermionic valve into a glow or arc discharge, as in the mercury vapour valve rectifier, so that the thyratron is an electrostatically controlled arc rectifier. To understand its operation then, it is necessary in the first place, to be quite clear how the ordinary half-wave mercury vapour rectifier works, and in what respects it differs from the vacuum diode.

The half-wave vapour rectifier consists

¹ This type of tube is usually referred to by the name 'Thyratron,' a proprietary title of the B.T.H. Co., Rugby, with whose kind permission it is used throughout this article.

² "The Thyratron Inverter" by F. Butler, B.Sc., *The Wireless World*, May 31st, 1935.

in its essentials of a directly- or indirectly-heated cathode which emits electrons and an anode, enclosed together in an atmosphere of mercury vapour. Fig. 1 shows an arrangement whereby an increasingly positive voltage may be applied to the anode of such a rectifier. With anode voltages up to about 40 volts an anode current of a few milliamperes will be obtained which will increase as the anode voltage is increased. Exactly the same effect would be obtained if the rectifier were replaced by a vacuum diode, except that the anode current would be a little greater. This is shown by the broken curve in Fig. 2, and is due to the delays caused to the electrons in the rectifier by collisions with molecules of the vapour.

Each increase in anode voltage, however, causes not only an increase in the number of electrons, and therefore in the anode current, but also an increase in the average velocities with which they approach the anode. In consequence, there comes a time when the electrons possess sufficient kinetic energy to ionise the mercury vapour, i.e., to split up the molecules of mercury with which they come into collision into two parts: positive mercury ions and electrons or negative ions.

The anode voltage at which ionisation occurs depends upon the temperature and pressure of the vapour, but usually lies between 40 and 50 volts. On ionisation the voltage drop across the tube falls to about 15 volts, as shown in Fig. 2, again

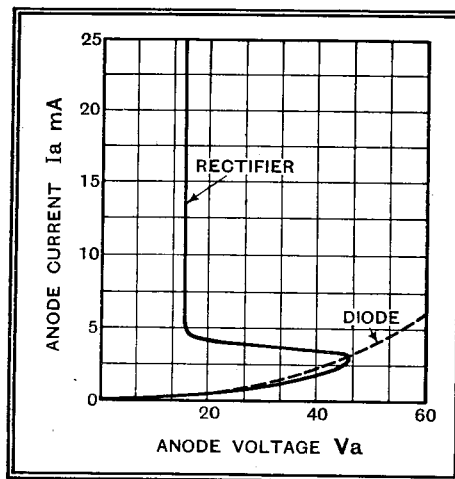

Fig. 2.—Anode voltage/anode current characteristics for (a) Mercury vapour half-wave rectifier, as shown by solid curve, (b) Vacuum diode as shown by broken curve.

THE sphere of usefulness of electron tubes has been considerably widened during the past few years by the development of the "Thyratron," gas filled relay, or grid-controlled rectifier, as it is variously called. It is now extensively used to produce linear time bases for application to cathode ray tubes, and will probably be employed extensively for television.

depending upon the temperature and pressure. At the same time there is an immense increase in anode current and fall in impedance, for two reasons.

First, the positive ions which are attracted to the cathode are of opposite sign to the electrons, so that their electrostatic fields neutralise and there is no space charge to hinder emission.

Second, the emission of the cathode is increased many times by the electrons

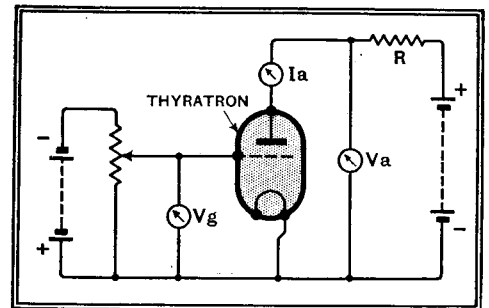

Fig. 3.—Circuit for determining the critical grid voltage and control ratio of a thyratron.

which are released by the impact of the heavy positive ions upon the electron-emitting surfaces of the cathode. It is for this reason that the anode voltage required to *maintain* ionisation is less than that required to *produce* it, and the anode voltage falls to about 15 volts.

It will be observed from Fig. 2 that the curve becomes parallel to the current axis on ionisation, so that the impedance is now zero, a feature in sharp contrast with the thermionic diode, the impedance of which is always several thousand ohms. Consequently, if the cathode is not to be damaged by too great an emission it is necessary to limit the anode current which flows by a suitable resistance R.

To turn a rectifier into a thyratron it is merely necessary to add a third electrode, in the form of a grid, between the anode and cathode. We have then an arrangement which is essentially a three-electrode thermionic valve, with the addition of a little mercury vapour.

If the grid of a typical thyratron, such as the MR/ACr, is maintained at a constant negative voltage of about -10 volts, by means of the circuit shown in Fig. 3, and +100 volts is applied to the anode, the electrostatic field surrounding the anode is largely neutralised at the cathode by the field of the grid. The number and average velocities of the electrons which are attracted to the anode is therefore greatly reduced by the presence of the negatively charged grid. So much re-

Thyratrons—

duced, in fact, that although the anode voltage is twice that previously required to produce ionisation, yet, because the velocities of the ions are insufficient to produce it, ionisation does not occur.

If the grid is now made progressively less negative by means of the potentiometer more electrons will be attracted to the anode at increasingly greater veloci-

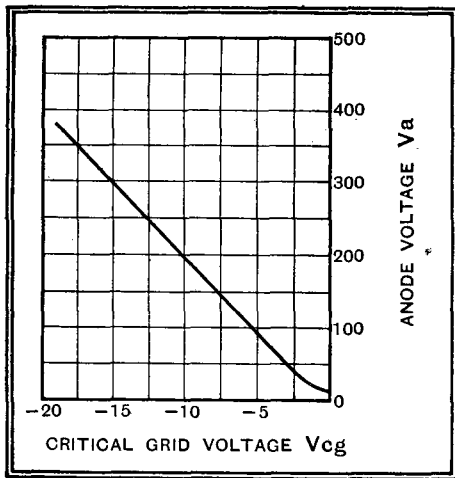

Fig. 4.—Critical grid voltage V_{cg} as a function of anode voltage V_a for a typical thyratron, the MR/AC1.

ties, until ionisation will occur exactly as before in the case of the diode rectifier; moreover, the current which flows will again depend entirely upon the resistance of the external circuit. For example, the maximum permissible anode current of the MR/AC1 is 150 mA. at any voltage up to 1,000 volts. Supposing that we wish to operate this thyratron at 150 volts and full load, then by Ohm's law, after allowing for a drop of 15 volts across the tube, the resistance needed is $135 \div 0.15 = 900$ ohms.

The ratio of the negative critical grid voltage to positive anode voltage which will just allow the tube to "strike" is called the "control ratio." The critical grid voltage V_{cg} for the MR/AC1 is shown in Fig. 4 as a function of the anode voltage. It will be seen that for most values of the anode voltage the control ratio is a constant.

Once the tube has struck, the grid is powerless to stop or control the anode

current in any way because of the positive ions which are immediately attracted to it. These ions form a sheath about the grid, the outside of which is at the potential of the discharge. The effect of the grid upon the electron flow is therefore entirely neutralised, and a variation in grid potential results only in a corresponding variation in the thickness of this sheath.

The grid can only regain control if the anode voltage is interrupted completely, or lowered below that necessary to maintain ionisation, i.e., below about 15 volts. The time taken by the negatively charged grid to attract the positive ions which remain after the arc is extinguished is only a matter of about one millisecond (the "deionisation time"), after which, if the grid is sufficiently negative, it will again prevent ionisation and the tube from striking when voltage is next applied.

Safeguarding the Tube

Should the grid become positive while the arc is established a considerable grid current will flow which may cause damage to the cathode by over-emission. It is therefore always desirable to operate with a resistance of from 10,000 to 100,000 ohms directly in the grid circuit, a precaution which in no way interferes with the control when the grid is negative. It is also extremely important when using a thyratron always to allow a few minutes for the cathode to heat up to its correct working temperature before switching on the anode voltage. Failure to do this usually results in the complete destruction of the cathode.

A list of thyratrons is given in the accompanying table. It does not claim to be exhaustive, for thyratrons are manufactured capable of carrying up to 60 KVA. in their anode circuits, while present developments will probably treble this rating; it does, however, give all those likely to be of use to the experimenter. The maximum inverse voltage refers to the maximum voltage which may be safely allowed across the tube in the reverse direction, e.g., as would occur if an alternating voltage were applied to the cathode. The mean anode current is the maximum which may be passed continuously.

THYRATRONS AVAILABLE TO THE EXPERIMENTER.

Type.	Cathode.		Anode Current Amperes.		Maximum Inverse Volts.
	Volts.	Amps.	Mean.	Max. Inst.	
B.T.H. (Mazda):					
BT1	2	5	0.3	0.9	1,000
BT5	5	4.5	2.5	12.5	1,000
BT8	2	2.5	0.06	0.275	500
BT19	2.5	5	0.5	2.0	1,000
Cossor: GDT4	4	1.5	0.02	0.5	500
Ediswan: MR/AC1	4	1.2	—	0.15	1,000
HE/AC1	4	1.2	—	0.15	1,000
Osram: GT1	4	1.3	0.4	1.0	1,000
GT1A	4	1.3	0.3	0.6	250
GT5E	4	5.0	2.5	5.0	2,000

All of these thyratrons are mercury filled with the exception of HE/AC1 which contains helium and GT1A which contains argon.

A thyratron-controlled circuit for producing "saw-tooth" voltage waveforms for use with cathode ray tubes is shown in Fig. 5. It consists of a thyratron, across which is connected a condenser C. The condenser is in series with a saturated diode, which, therefore, passes a constant current. The voltage across the condenser builds up at a constant rate, thus giving the uniform velocity stroke of the saw-tooth. This continues until the voltage across the condenser is large enough to cause the thyratron to strike. The condenser then discharges quickly through the thyratron and gives the rapid fly-back. For the diode, a valve which is easily saturated is required. An old bright emitter with the grid connected to the anode is excellent, a thoriated filament valve is not so good, and an oxide-coated one quite useless.

For the successful operation of cathode ray tubes it is essential that the frequency of the time base shall be stable, and remain always in perfect synchronism with the "work" voltage applied to the vertical deflector plates. This is obtained by

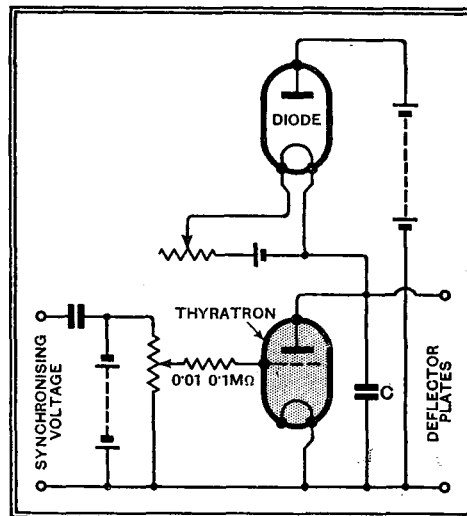

Fig. 5.—A thyratron-controlled linear time base as used with cathode ray oscillographs and television receivers.

feeding into the grid circuit of the thyratron a small fraction of the work voltage by means of the terminals marked "Synchronising Voltage" in Fig. 5. In this way a small alternating voltage of the same frequency as the work voltage is superimposed upon the mean negative grid potential, so that if the natural period of the time base is reasonably near to a multiple of the work period, each swing in voltage of the grid causes the thyratron to strike at the work period, and perfect synchronism results.

The natural period of the time base may be varied within limits by adjustment of the diode filament current, or of the thyratron grid voltage, or both. The value of the condenser C depends upon the frequency f , the charging current I_c , and the difference between the striking and extinguishing voltages of the thyratron V_d . A suitable value may be

$$\frac{1}{f} = C \frac{V_d}{I_c}$$

where the units are farads, ohms, volts and seconds.

BROADCAST

By Our Special Correspondent

BREVITIES

In Camera

THE evidence which is being given before the Ullswater Committee is, I understand, almost complete, but information as to who has been called is a closely guarded secret.

The members of the Committee are at the present time away, and will not be back in London until October, when it is anticipated they will declare their findings. Any information which has so far been given in the lay Press is, I am told, purely anticipatory, although that which stated there is to be no advertising matter in the programmes under the new Charter was, of course, a foregone conclusion.

Linking Television Stations

SINCE the Post Office announced some weeks ago that a new telephone line, capable of handling television frequencies, was to be laid between London and Birmingham, it is, I think, fairly safe to say that the first provincial station will be there.

Birmingham has for some time been associated with television, as the sound for the low-definition transmissions was transmitted on the Midland Regional wavelength.

New Television Department

An indication of the three distinct types of programme to be given from the Alexandra Palace transmitter is apparent from the fact that there is to be a Productions Manager, a Film Assistant, and a Topical Editor. These appointments will be made from among the staff at Broadcasting House. I understand that the whole of the staff connected with the low-definition transmissions is to be transferred to the new station when the necessary alterations have been completed. The vacated space at Broadcasting House will no doubt soon be filled by the continuous expansion of the personnel.

A Place of Honour

What is to happen to the old low-definition apparatus? This has served for three years as the pioneer of Britain's television service. Surely no more fitting place than the Science Museum, South Kensington, could be found for this faithful servant, where it would be in company with the original television apparatus of Mr. J. L. Baird.

Another Control Panel

AN interesting and ingenious new instrument, known as a Recording Mixer, is to be used at Broadcasting House. In appearance it is similar to the dramatic control panel. It has six control knobs, each with its associated switch, but, whereas in the dramatic panel these are to control the merging together of studio outputs, in the new panel they are each connected to a gramophone pick-up.

The arm on each turn-table is not pivoted, but traverses a wormed rod, and can therefore be set to start at any given groove on the record; by this means predetermined sections of six records can be merged.

Mixing Records

The usefulness of this instrument is apparent when it is realised that, as is often the case, a long recording of some event by the "O.B." van or excerpts from a lengthy speech which is to be broadcast can be so edited as to give only the sections needed and yet still to retain continuity.

Not only is this instrument to be used for broadcasting, but it can also be utilised for re-recording, thereby obtaining a record of sections required.

New York Representative

THE appointment of Mr. Felix Greene as representative of the B.B.C. for the North American Continent, with headquarters at New York, is not surprising when one considers how popular American relays, such as "Five Hours Back" and "Transatlantic Bulletin," have become. It is interesting to note that both the National Broadcasting Company and the Columbia Broadcasting System have recently appointed permanent representatives in London.

An Ambassador

The need for such a link between the two continents was suggested editorially in *The Wireless World* of July 12th.

Mr. Greene will act in a liaison capacity, and, being on the spot, will also be able to get

New Empire Transmitters

IT is announced by the B.B.C. that contracts have been placed with Marconi's Wireless Telegraph Co., Ltd., and Standard Telephones & Cables, Ltd., for each to construct one of the new Empire short-wave transmitters.

Work will shortly begin on the construction of a new building at Daventry to house the transmitters, while a greatly extended aerial system is also to be erected.

Young Ideas

BEGINNING on October 4th a new half-hour feature programme of considerable interest will be presented every Friday evening at 7.30. This feature will be entitled "Young Ideas: A Programme of Entertainment and Information for Young People of All Ages." It will consist of a number of short items strung together somewhat in the manner of "In Town To-night." Most of the items will be talks devoted to a wide variety of topical subjects, though there will also be included outside relays and musical turns.

Current Topics

Among the subjects upon which it has been decided to touch are: Reviews of current affairs; eye-witness accounts of topical events; true adventure stories and readings of short stories; modern science and engineering; descriptions by young people of jobs they have taken up; athletics and sport of all kinds; and useful hints on hiking, cycling, food and various domestic problems.

Unrehearsed Debates

DEBATES which are very obviously read from carefully studied scripts which the protagonists have compared and discussed beforehand are always lacking in spontaneity and genuine vigour. An experimental unrehearsed debate was tried earlier in the summer, and proved sufficiently successful to justify a place in the winter's programmes.

During the winter months, therefore, unrehearsed debates in which the subject is given some time beforehand and thought out, but not discussed, will be given with the actual spontaneous argument and the give-and-take, carefully controlled and balanced by an experienced chairman.

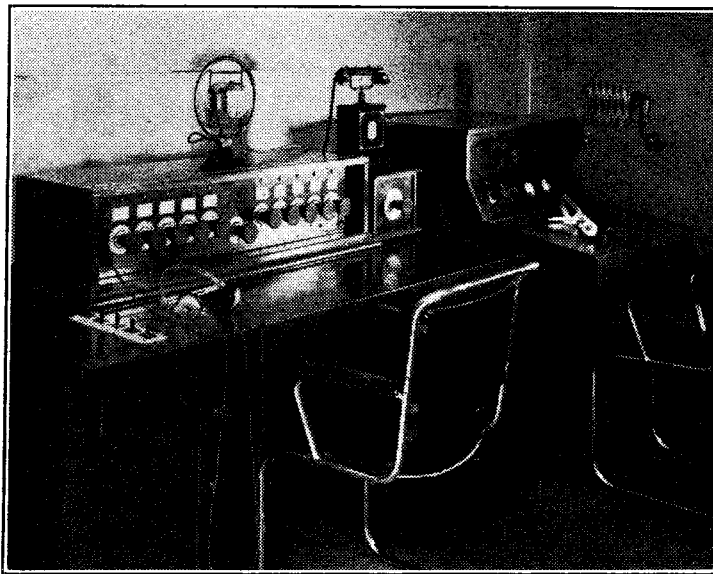

MANCUNIAN CONTROLS. Dramatic and music control panels in the controlling engineers' room at Broadcasting House, Manchester. The new Recording Mixer which is to be used at Portland Place is very similar in appearance to that shown on the left of this photo.

The controller will be given details such as these: Record 1, Grooves 12-20; Record 2, Grooves 8-24; and so on, the tell-tale on the panel giving an indication of the grooves as traversed, thus enabling him to see when to switch over to the next record.

the best out of American programmes for the British listener; which is, of course, not the easiest of tasks, especially when it is remembered that a large percentage of the American matter put "on the air" is inseparably linked with advertising.

Letters to the Editor

The Editor does not hold himself responsible for the opinions of his correspondents

The Flat-dweller's Aerial

I NOTICED in your issue of August 16th on the "Readers' Problems," page a reference to bad reception in a flat in a steel-framed building. Has your correspondent tried the scheme of connecting the aerial terminal to the hot water tap and the earth to the cold tap? In some circumstances this arrangement is much better than an indoor aerial or the mains aerial, and it does not invoke landlords' displeasure as would an aerial hanging from the window!

J. ANSELL.

Ealing.

Battery or Mains

IN his article comparing the relative advantages of different methods of power supply, Mr. Scroggie has pointed out the economy of operation of a Milnes Unit. Unfortunately, the figures which he gives are not so convincing as they ought to be, as Mr. Scroggie has included in his figures for HT supply, that of LT consumption also.

On the average, the drain on the low-tension accumulator due to the Milnes Unit is only about one half of that taken by the filaments of the valves, and, therefore, Mr. Scroggie's figure for the cost of operating the unit is 200 per cent. in excess of what it should be.

The figures so amended agree quite well with the fact that dealers in various parts of the country are prepared to charge accumulators as often as required for a payment of 6d. per week to maintain both the LT supply and the Milnes Unit. On this basis, the Milnes Unit is supplying a steady HT current for 2d. per week.

ALFRED T. FLEMING, M.I.W.T.,
General Secretary,
The Wireless League.

The Science Museum Receiver

I SHOULD be very much interested if you, or any of your readers, could tell me if there is to be a 1935 edition of the Kensington Science Museum Receiver. This receiver was last produced in 1930 and described by you in your August 6th, 1930, issue, and interested me very much.

Without wishing to belittle in any way the vast developments in the technique of wireless reception since that date, I find it difficult to believe that much has since been achieved as regards fidelity of reproduction, which, I maintain, is the primary objective. G. W. HARPER,

Havant. Lieut.-Commander, R.N.

Out-of-Date Hospital Sets

I READ with much interest the mention of "Hospital Wireless" in your issue of August 30th.

The *News Chronicle* deserves every support in their practical scheme for alleviating the monotony of hospital life; I speak from experience.

As far back as 1927 I benefited by the thoughtfulness of the *News Chronicle*. The hospital I was in had just received a wireless installation from them. In January this year I was again a patient in this hospital and the same equipment was in use. It is hardly needful to say the re-

ception this time was very indifferent; even the best equipment needs renewing. Sometimes the reception was so overloaded that it was painful to listen to, at other times one could hardly hear anything.

Surrey. E. S. MASON.

Permeability of Nickel-iron Alloys

IN recent issues of the *Wireless World* very useful and instructive articles on the design of chokes and transformers with Radiometal and Mumetal cores have appeared. In one article the author gave curves of incremental permeability with polarising current taken from the catalogue of the Telegraph Construction and Maintenance Co., Ltd., the manufacturers of these alloys. Measurements for the basis of these curves were made on a modified form of Hay's Bridge utilising AC superposed on DC in order to simulate the conditions applying in practice, viz.: anode feed plus signal or residual mains hum on DC. It is, of course, possible to apply a direct current to a choke winding and find the resultant change in B due to a small change in H, but the deduced permeability is not the incremental permeability which is used in choke design. The incremental permeability cited in the published curves varies with the frequency of the AC and decreases with increase in frequency.

It is of interest to mention that in the

case of the nickel-iron series of alloys (Mumetal, Radiometal, etc.) the values of permeability derived from direct current B-H curves are not applicable to AC problems. This is due to the fact that the AC ampere-turns on a choke, for example, are not all effective as magnetising ampere turns, the actual value of the latter being derived as follows:

$$\text{Let } \omega = 2\pi f$$

L = Inductance of choke in henrys.

f = Frequency of testing current.

AR = Iron loss resistance.

$$\frac{\omega L}{AR} = \tan \theta$$

N = Turns on choke.

I = Total testing current.

i = Mean magnetic length of specimen.

$$H = \frac{4\pi IN}{10^9}$$

B = Flux density.

Then, magnetising $H = H \sin \theta$

and Loss $H = H \cos \theta$

As a result, within the limits of the form factor remaining 1.11, the values of DC permeability can be derived from an AC series of measurements by using the formula

$$\mu = \frac{B_{\max}}{H_{\max} \sin \theta}$$

For Mumetal the value of θ may be less than 20 degrees. Hence, although the method of measuring inductance by determining the volts drop across a choke for a definite current and assuming $IZ = I\omega L$ may be applicable to silicon iron, it will frequently give erroneous results for Mumetal.

London. G. A. V. SOWTER,
B.Sc., A.M.I.E.E.

Random Radiations

By "DIALLIST"

A Way They Have in China

I FIND myself vastly diverted by the recent decree of the Peking Government on the subject of Children's Hour broadcasts. We are apt at times to regard our own B.B.C. as somewhat grandmotherly and Mrs. Grundy-ish owing to the way in which it sifts its programme material. But anything that the B.B.C. has done pales into insignificance beside the edicts of Peking. They have laid down in black and white that no songs or stories are to be broadcast which might give naughty children food for laughter. Fun must never be made of Father; Auntie must never do in the studio the silly things that Aunties sometimes do in real life; the Terrible Infant must never score a triumph by word or deed, but must always earn a sound spanking.

My sympathies, frankly, are all with the Chinese child, and particularly with the naughty ones who are now to be deprived of the most entertaining parts of the Children's Hour broadcasts. Few joys in after life can compare with those of being thoroughly naughty on occasion in childhood's days—even though one knew well enough that just as the sword hung over the head of Damocles, so a parental slipper was metaphorically suspended above another part of one's person.

Towards the Kilocycle?

ON several occasions in the brief but eventful history of broadcasting there have been gallant but unsuccessful attempts

to make the listener at large think in kilocycles. Hitherto the listener at large (which means you and me, in case you haven't realised it) has obstinately refused to do anything of the kind. You remember what happened when the B.B.C. itself made its attempt to wean us from our wavelength-wardness? The B.B.C. people went the whole hog. They said: "Thinking in kilocycles is incorrect; it should be kilocycles per second. In other words, kilohertz." Manfully they persevered for quite a while in their efforts, but conversions were so few and so far between that a return to wavelengths had to be made.

There are signs that we are now on the way towards a peaceful revolution in the matter of wavelengths *versus* kilocycles, the operating cause of this upheaval being the all-wave receiving set, which is causing numbers of people to explore for the first time regions in which a round number in kilocycles is a far, far better thing than a wavelength containing a couple of decimal places.

Pros and Cons

The chief reason why the battle has so far gone in favour of those who delight in wavelengths and spurn the kilocycle is that at the beginning of broadcasting, when stations were few and far between and there was no need for Geneva, Prague or Lucerne Plans, every station had a wavelength in

Random Radiations—

nice round figures, and most wireless enthusiasts knew by heart the wavelengths of pretty well all the existing stations. As fresh stations came into action their wavelengths were memorised, which was no very difficult feat.

Having equipped himself with a memorised wavelength table, your enthusiast was loth to scrap it and start all over again. Further, he had probably prepared calibration charts in wavelengths for one or more receiving sets. He didn't feel at all drawn to kilocycles; and as for kilohertz. . . . The coming of the straight-line wavelength variable condenser rather strengthened his position, though this became somewhat more shaky when the log-mid-line condenser made its appearance. In other countries the kilocycle has been adopted wholeheartedly; it might have had equal success here had there not been organised attempts to ram it willy nilly down our throats. For short-wave work, as well as for work upon the medium and long wavebands, where channels are allocated to broadcasting stations on the basis of a 9-kilocycle separation, it has obvious advantages. I can't help thinking that as time goes on the listener at large will tend to discard the wavelength in favour of the more convenient and more logical kilocycle.

Fashions in Tuning Dials

WHAT big changes there have been in tuning dials in the last few years! For a long while the only kind of dial to be seen was the three-inch disc of ebonite or bakelite, graduated in 180 degrees or 100 divisions. This was attached direct to the spindle of the variable condenser, and in the days before ganging many sets sported three or four of these dials. Then

came the slow-motion dial, with the same graduations and fitted also outside the panel of the receiving set. During the last few years the dial marked off into divisions or degrees has almost disappeared, except in experimenters' receiving apparatus, and there has been something of a battle between station names and wavelengths in metres for dial markings. It seemed at one time as if the dial with station names would become the most popular, and unquestionably it would have done if, on the one hand, it were possible to make it strictly accurate by mass-production methods, and, on the other, some means could have been found

of keeping it always up to date. Many of these dials are accurate enough for practical purposes, but wavelength changes and the appearance of new stations furnish a problem to which no complete solution has yet been found.

This year the wavelength dial seems to be making strong headway, particularly in all-wave sets. It is a pity from many points of view that the man in the street has shown so determinedly that he will have nothing to do with kilocycles, for frequencies are much more convenient than wavelengths for dial graduations, particularly on the short waves.

Manchester Radio Exhibition

IN THE CITY HALL, DEANSGATE

Friday, Sept. 20th to Saturday, Sept. 28th

LIST OF EXHIBITORS

	Stand No.		Stand No.
ADEY Portable Radio	27	Central Equipment, Ltd.	71
Aerodyne Radio, Ltd.	44	City Accumulator Co., Ltd. ..	4
Ambassador Radio Gramophones	99	Clarke, H. & Co. (M/c), Ltd. ..	28
BALCOMBE, A. J., Ltd.	53	Cole, E. K., Ltd.	29
Beardsall, W. E., & Co.	69	Cossor, A. C., Ltd.	30
Beethoven Radio, Ltd.	55	DAWES, F.	98
Belling & Lee, Ltd.	26	Decca Gramophone Co.	65A
Britannia Batteries, Ltd.	2	Dulcet-to-Polyphon, Ltd.	58/9
British Blue Spot Co., Ltd. ..	62	ECONASIGN Co., Ltd.	74
British Pix Co., Ltd.	79	Epoch Reproducers, Ltd.	75
British Television Supplies, Ltd.	24	Ever Ready Co. (G.B.), Ltd. ..	41
Brown Bros., Ltd.	40/56	FERRANTI, Ltd.	19
CECIL (Leicester), Ltd.	77	Frys (London), Ltd.	70
Celestion, Ltd.	57	GENERAL Electric Co., Ltd. ..	17
		Gramophone Co., Ltd.	64
		Grampian Reproducers, Ltd. ..	22
		HACKER, H., & Sons	65
		Halcyon Radio, Ltd.	43
		Hartley-Turner Radio, Ltd. ..	5
		Hellesens, Ltd.	32
		Hobday Bros., Ltd.	12/13
		Hollingdrake, H., & Sons, Ltd. ..	95
		LAMPEX Radio & Electric Co. ..	27B
		Lissen, Ltd.	52
		MARCONIPHONE Co., Ltd.	50/51
		Mullard Wireless Service Co., Ltd.	14/15
		ODHAMS Press, Ltd.	76
		PARK Wireless Depot, Ltd.	92
		Partridge, Wilson & Co., Ltd. ..	60
		Pye Radio, Ltd.	16
		R.A.P., Ltd.	66
		Regentone Products, Ltd.	54
		R.W. Products	75A
		SIEMENS Electric Lamps & Supplies, Ltd.	31
		Star Radio Products, Ltd.	96
		Sterling Batteries, Ltd.	70A
		TANNOY Products	25
		The 362 Radio Valve Co., Ltd. ..	78
		Trader Publishing Co., Ltd.	23
		ULTRA Electric Ltd.	42
		Universal Electric Supply Co., Ltd. ..	72/73
		WELLWORTH Wireless Co.	93
		Westinghouse Brake & Signal Co., Ltd. ..	3
		Whiteley Electl. Radio Co.	39

Guide to the Stands

The Exhibition is Open Daily from 11 a.m. to 10 p.m.

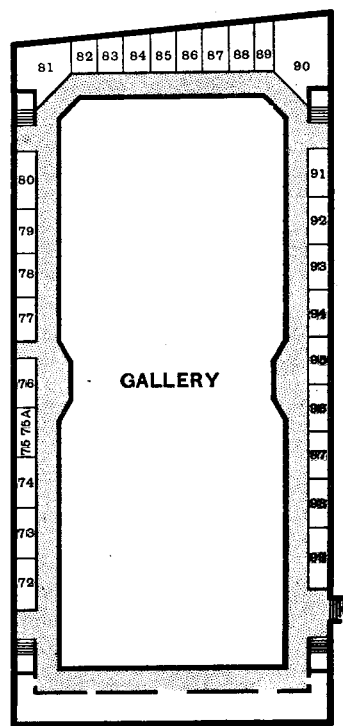



No. 839.

FRIDAY, SEPTEMBER 27TH, 1935.

VOL. XXXVII.

No. 13.

Proprietors : ILIFFE & SONS LTD.

Editor :
HUGH S. POCOCK.

Editorial,
Advertising and Publishing Offices :
DORSET HOUSE, STAMFORD STREET,
LONDON, S.E.1.

Telephone: Hop 3333 (50 lines).
Telegrams: "Ethaworld, Sedist, London."

COVENTRY: Hertford Street.

Telegrams: "Autocar, Coventry." Telephone: 5210 Coventry.

BIRMINGHAM:

Guildhall Buildings, Navigation Street, 2.
Telegrams: "Autopress, Birmingham." Telephone: 2971 Midland (4 lines).

MANCHESTER: 260, Deansgate, 3.

Telegrams: "Iliffe, Manchester." Telephone: Blackfriars 4472 (4 lines).

GLASGOW: 26B, Renfield Street, C.2.

Telegrams: "Iliffe, Glasgow." Telephone: Central 4857.

PUBLISHED WEEKLY. ENTERED AS SECOND CLASS MATTER AT NEW YORK, N.Y.

Subscription Rates:

Home, £1 1s. 8d.; Canada, £1 1s. 8d.; other countries, £1 3s. 10d. per annum.

As many of the circuits and apparatus described in these pages are covered by patents, readers are advised, before making use of them, to satisfy themselves that they would not be infringing patents.

CONTENTS

	Page
Editorial Comment	339
The 1936 Battery Monodial Super	340
The Development of the Wireless Aerial	344
Unbiased	346
Current Topics	347
Practical QAVC Circuits.. ..	348
Acoustics in the Open	351
G.E.C. AC Mains Four Reviewed	352
Listeners' Guide for the Week ..	354
New Apparatus Reviewed ..	356
The Radio Shows Compared ..	357
Random Radiations	358
Broadcast Brevities	359
Readers' Problems	360

EDITORIAL COMMENT

A Suggested Innovation *Talks and Education on One Station*

WE do not yet know what may be the recommendations concerning the renewal of the B.B.C. Charter which the Ullswater Committee may make, but it is interesting to note that there is a good deal of speculation on the part of writers to the popular Press as to what changes may be proposed.

Some of the forecasts which are being put forward are manifestly imagination. The Ullswater Committee is concerned with main issues and will not make recommendations regarding details of the broadcasting organisation, yet forecasts have appeared dealing with probable changes which are quite domestic in character.

It is not within the province of the Committee to recommend changes in the distribution of programmes, so that suggestions as to how station time may be re-allotted in the future must be regarded as B.B.C. projects and not due to any influence the Committee may have.

Proposals We Endorse

We have noticed, in particular, that a rumour is current that educational broadcasting may shortly be transferred to an exclusive wavelength. If such a proposal is adopted we should be the first to welcome it. We have already expressed the view that what may be termed educational broadcasting, as distinct from entertainment, ought not to be sandwiched in amongst a programme of a popular character; we have made the suggestion that a partial solution of the difficulty might be arrived at if the B.B.C. could devote the time of one station mainly to educa-

tional matter and pursue a policy of giving more solid material on specialised subjects, and try to forget, for once, what at present must be the constant urge to make every programme appeal to the majority. An exclusive wavelength for the distribution of the more serious programme matter would not only be welcomed by the public but should, we imagine, simplify the difficult task which faces the programme compilers when they are expected to please every type of listener on every station during an evening's transmission.

Mains Borne Interference *Supply Company's Example*

AN important new step towards ridding the wireless set of interference has been taken by certain supply companies who now offer to fit interference suppressing devices of recommended type at consumer's premises. The consumer is expected to bear the cost of the suppression unit, but this involves an expenditure of only a few shillings and will, in most cases, result in a remarkable reduction of background noise.

It is to be hoped that this important example will be followed by supply companies throughout the country, when quite an appreciable reduction in interference should result. It is co-operation such as this which the Post Office welcomes as it contributes so much to reducing their task of investigating and recommending remedies in the homes of individual listeners.

Readers who suffer from this type of interference would be helping the general cause, as well as themselves, if they would approach their local supply companies for assistance.

The 1936 Battery Monodial

The Circuit Details: An Unusual Output Stage

By W. T. COCKING

THE design of a battery receiver having a high standard of performance offers several problems which do not occur in a mains set. In the first place, battery valves are less efficient than mains types, so that more stages are likely to be necessary to produce the same amplification, and it becomes more difficult to obtain adequate undistorted output. Secondly, it is so very much more expensive to obtain the power necessary for operating a receiver from batteries than from the mains that it is necessary to take great care to see that there is no wastage. Even when the power consumption has been reduced to the bare minimum, it is often too high for economical operation, and it can then be reduced only by some sacrifice of performance.

The difficulties associated with battery supply are chiefly with the HT battery, and if small dry cells be used the total current drawn from them can hardly exceed 10 mA. if they are to have a reasonably long life. Quite a sensitive and selective set can be constructed within such a limit, but it is likely to fail in its power of giving high-quality reproduction at any adequate degree of volume. The volume of sound from a loud speaker depends upon the power which the output stage can supply to it, and this power must come initially from the HT battery. The advent of quiescent types of output stage has enabled a great reduction to be made in the average power drawn from the battery if not in the instantaneous power. Even so, the consumption of a highly sensitive receiver which is designed for good quality and volume must inevitably be greater than the economical limit of small dry batteries.

In the 1936 Battery Monodial, therefore, no attempt has been made to keep the current consumption low enough to permit a small dry battery to be used, for this would have involved too great a sacrifice in performance. No wastage of

THE limitations imposed by the small dry battery have led of recent years to concentration upon economy of current consumption as the primary factor in the design of a battery receiver. Some designers have forgotten that there are very many listeners who are prepared to employ HT accumulators in order to secure the higher standard of performance only obtainable with the heavier current consumption. The 1936 Battery Monodial Super fills the gap in performance which has for so long existed between the battery set and the all-mains receiver

current has been permitted, of course, and full use is made of every milliampere drawn from the HT supply. The receiver is consequently intended for operation from the largest size dry batteries or from HT accumulators.

The complete circuit diagram of the receiver is shown in Fig. 1, and of the output stage in Fig. 2. It will be seen that a signal-frequency HF stage is employed, and that there is a single tuned circuit coupling it to the aerial. A further tuned circuit provides the coupling between this valve and the frequency-changer, and gives a total of two signal-frequency tuned circuits. In view of the comparatively high intermediate frequency used (465 kc/s), these circuits afford ample protection against second-channel interference under practically all conditions. They are, of course, tuned by two sections of the three-gang condenser and the four make-and-break switches, S1, S2, S3 and S4, short-circuit the long-wave windings of the coils on the medium waveband. AVC is applied to both the HF and frequency-changer valves, and the grid circuits are consequently decoupled by the 20,000 ohm resistances R1 and R3 in conjunction with the 0.1 mfd. condensers C2 and C5.

The frequency-changer is a heptode, the two inner grids of which are used for generating local oscillations, and which form the grid and anode of a conventional

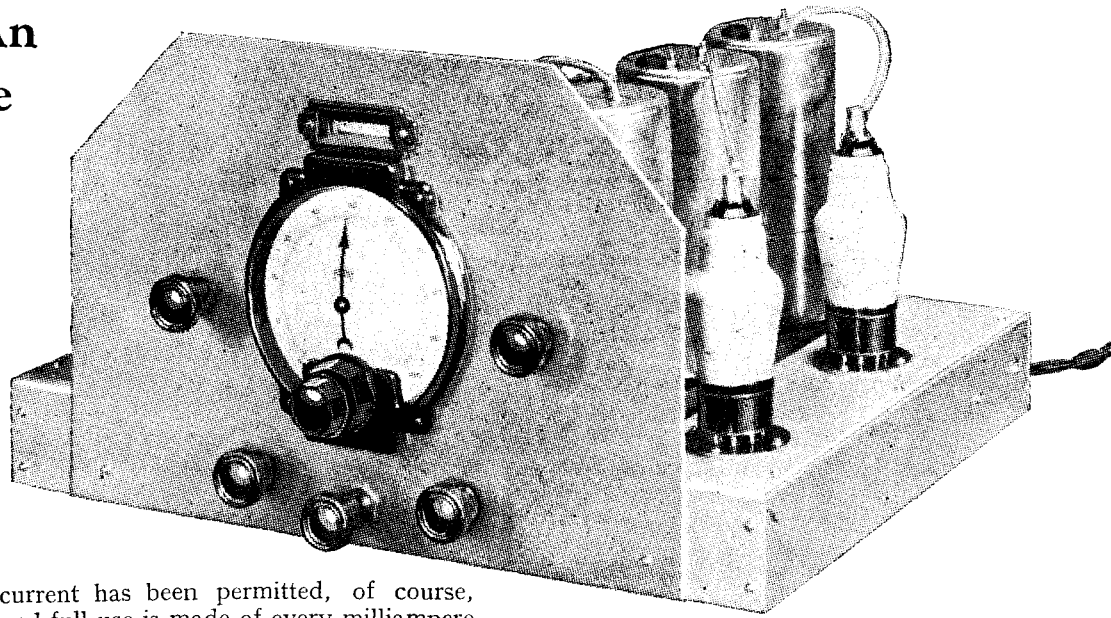

triode oscillator. The grid is biased by the flow of grid current through the 100,000 ohm resistance R4, and the tuned circuit is connected to the grid through the 0.0001 mfd. condenser C7. The apparent complexity of this portion of the circuit is due merely to the wave-band switching and to the arrangements made for tracking. On the medium

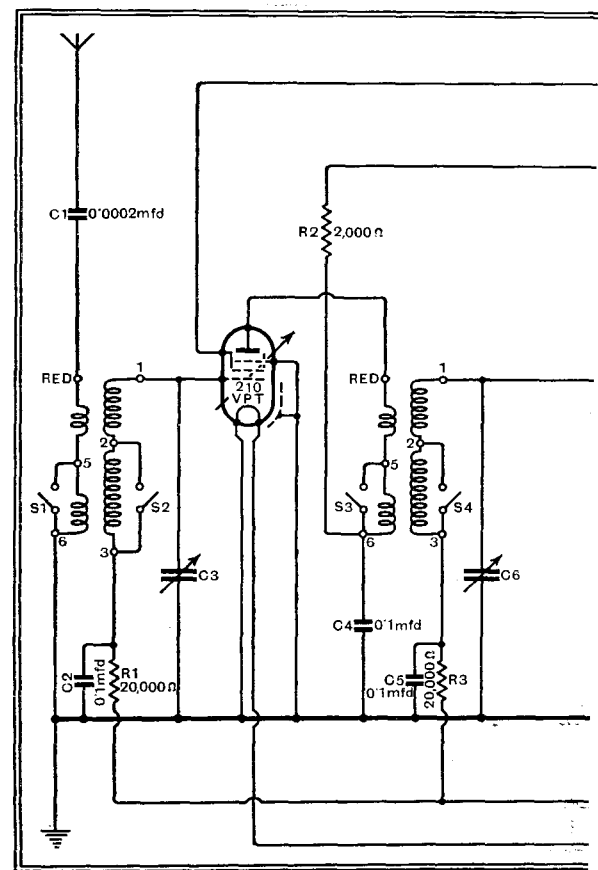
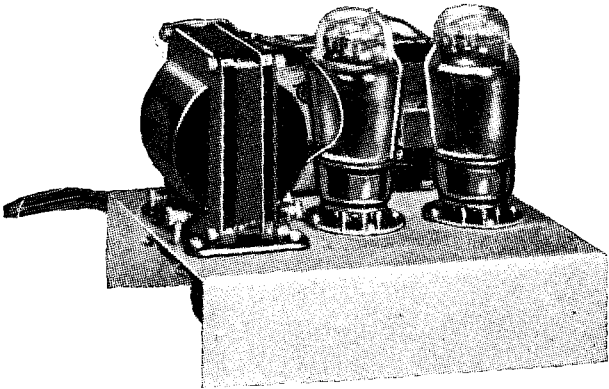

Fig. 1.—The complete circuit diagram of the receiver.

Super +++ A SENSITIVE HIGH-QUALITY RECEIVER +++

waveband S5 is open and S6 closed so that C12 is not connected, and the long-wave coil and long-wave padding condenser C13 are short-circuited. The



tuning of the circuit is then controlled by the variable condenser C9, which is one section of the three-gang condenser, and tracking is secured by means of the padding condenser C8 and the parallel trimmer on C9. On the long waveband S5 is closed and S6 open, so that the inductance is greater and the padding capacity is reduced by the introduction of C13. The parallel capacity, however, is increased by C12.

Turning now to the IF amplifier, two stages are used with HF pentode-type

valves and identical couplings. Each coupling consists of a pair of tuned circuits coupled together, the degree of coupling being controllable. When loose coupling is employed the maximum selectivity is secured, but when it is increased the selectivity falls, and the resonance curve assumes a flat top which permits the retention of the highest modulation frequencies.

The first IF valve is controlled for AVC purposes, and its grid circuit is decoupled by the 0.1 mfd. condenser C17 and the 100,000 ohm resistance R8. The second IF valve is not controlled, in order that AVC may function without introducing distortion on strong signals. If this stage were controlled there would be a serious risk of distortion in local reception by overloading this valve. In order to secure the maximum undistorted output this valve is operated with zero grid bias, even although this means some increase in anode current consumption.

A duo-diode-triode is employed following the last IF valve, and one diode is used for detection and fed from the secondary of the IF transformer. The diode load resistance R10 is given the usual value of 0.25 megohm, and a further resistance R11 of 50,000 ohms acts in conjunction with C23 of 0.0001 mfd. to filter out IF currents while per-

mitting the passage of LF currents. The coupling to the triode section of the valve, which acts as an LF amplifier, is through the 0.1 mfd. condenser C24 and the 1 megohm volume-control potentiometer R12. The anode circuit of this valve includes the primary of an LF transformer (Fig. 2), and is decoupled by the 1 mfd. condenser C26 and the 25,000 ohm resistance R15. Grid bias for the valve is obtained by returning the lower end of the volume control to the negative terminal of a single dry cell.

The AVC System

The second diode in this valve provides AVC, and it is important to note that the two diodes are not identical. The one used for detection is mounted round the negative leg of the filament, whereas that used for AVC is mounted round the positive leg. A delay of over 1 volt is thus secured without the need for biasing the AVC diode. In this case, this inherent delay is insufficient, however, and an additional bias of 1.5 volts is applied from a dry cell, and this potential also appears as initial bias on the three controlled valves. The AVC diode is fed from the primary of the last IF transformer through the 0.0002 mfd. condenser C21, and its load resistance R14 is given

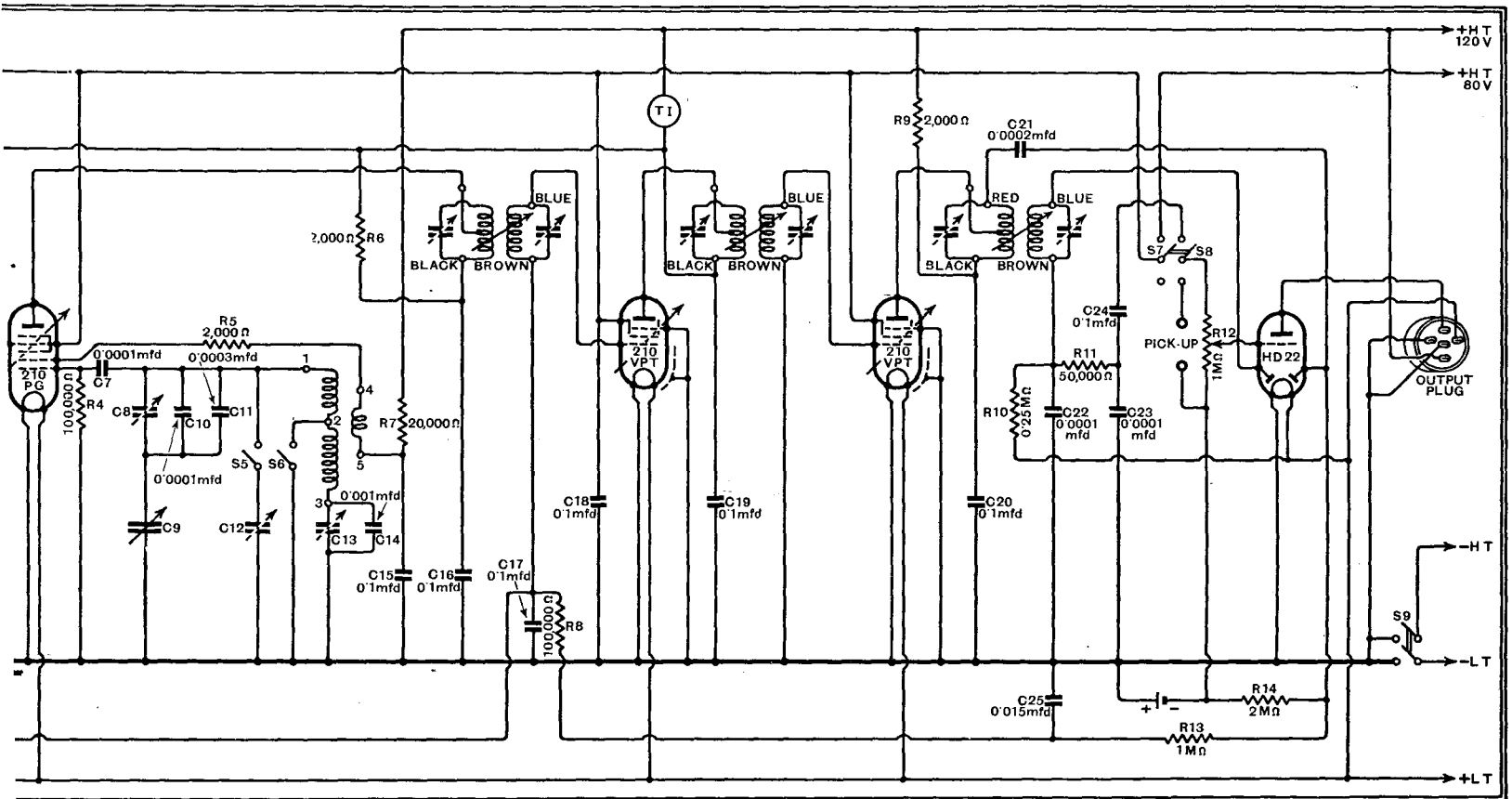

shows that two signal-frequency circuits are used with a heptode frequency-changer. There are two IF stages with variable selectivity and AVC is obtained with the aid of a duo-diode-triode.

The 1936 Battery Monodial Super—

a value of 2 megohms. Initial filtering of the output is carried out by the 1 megohm resistance R13 in conjunction with the 0.015 mfd. condenser C25, and is completed by the grid circuit decoupling components.

The output stage is somewhat unusual in that, although it is of the QPP type, two QPP valves are used in parallel. This is done in order to obtain increased output, although it necessarily involves an increase in the current consumption. As each QPP valve consists of two pentodes, this output stage really has four pentodes connected in parallel-push-pull. In this way the undistorted output is doubled. The stage is fed from the previous valve through a high-quality transformer of moderate ratio; the 150,000 ohm resistance R16 being connected from the centre tap on the secondary to the bias battery in order to suppress any tendency to parasitic oscillation.

The variable selectivity IF transformers can be seen on the left in this illustration, while the tuning indicator is visible above the gang condenser.

The receiver is intended for operation from an HT supply of 120 volts, although a higher voltage can with advantage be used if the increase in current consumption is not considered objectionable. The full voltage is accordingly applied to the anodes and space-charge grids of the output valves, and the full voltage less the unavoidable drop in

the decoupling resistances to all the early valves. The second IF valve has a true anode potential of about 112 volts, for it passes some 4 mA. and has a decoupling

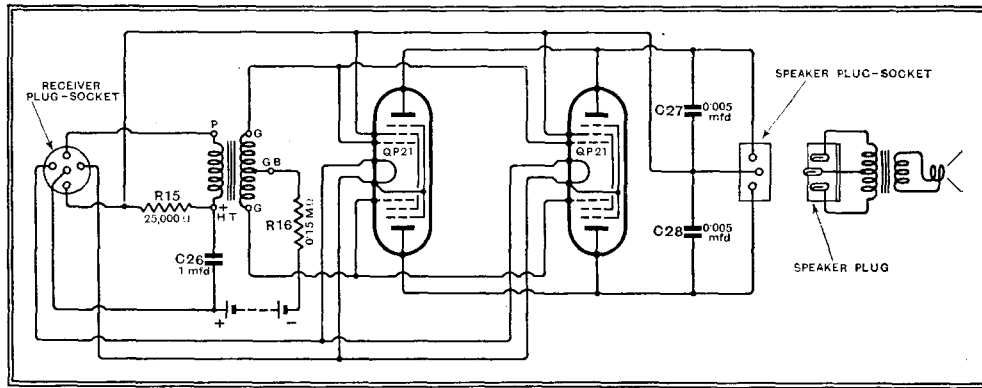

Fig. 2.—Two QPP valves are used in the output stage and fed by a push-pull transformer.

resistance R9 of 2,000 ohms. The anodes of the three controlled valves are at a slightly lower potential, for they are not only decoupled but have in the common supply line the tuning indicator, which has an internal resistance of some 5,000 ohms. The screen grids are all connected together and joined to an 80-

the connections to the output circuit are taken on the receiver side of this switch so that it controls both units simultaneously. The radio - gramophone

switch is provided with contacts S7 which break the screen circuit of all early valves on gramophone, and this not only prevents interference from radio, but reduces the HT current of the first four valves to zero, thus making for economical operation. With this same end in view of economy of current consumption a millimeter-type tuning indicator has been selected instead of a neon-indicator, for the latter must consume some 5 mA., which can be more usefully employed in a battery receiver.

The construction and adjustment of the receiver will be dealt with next week, but some notes regarding the associated

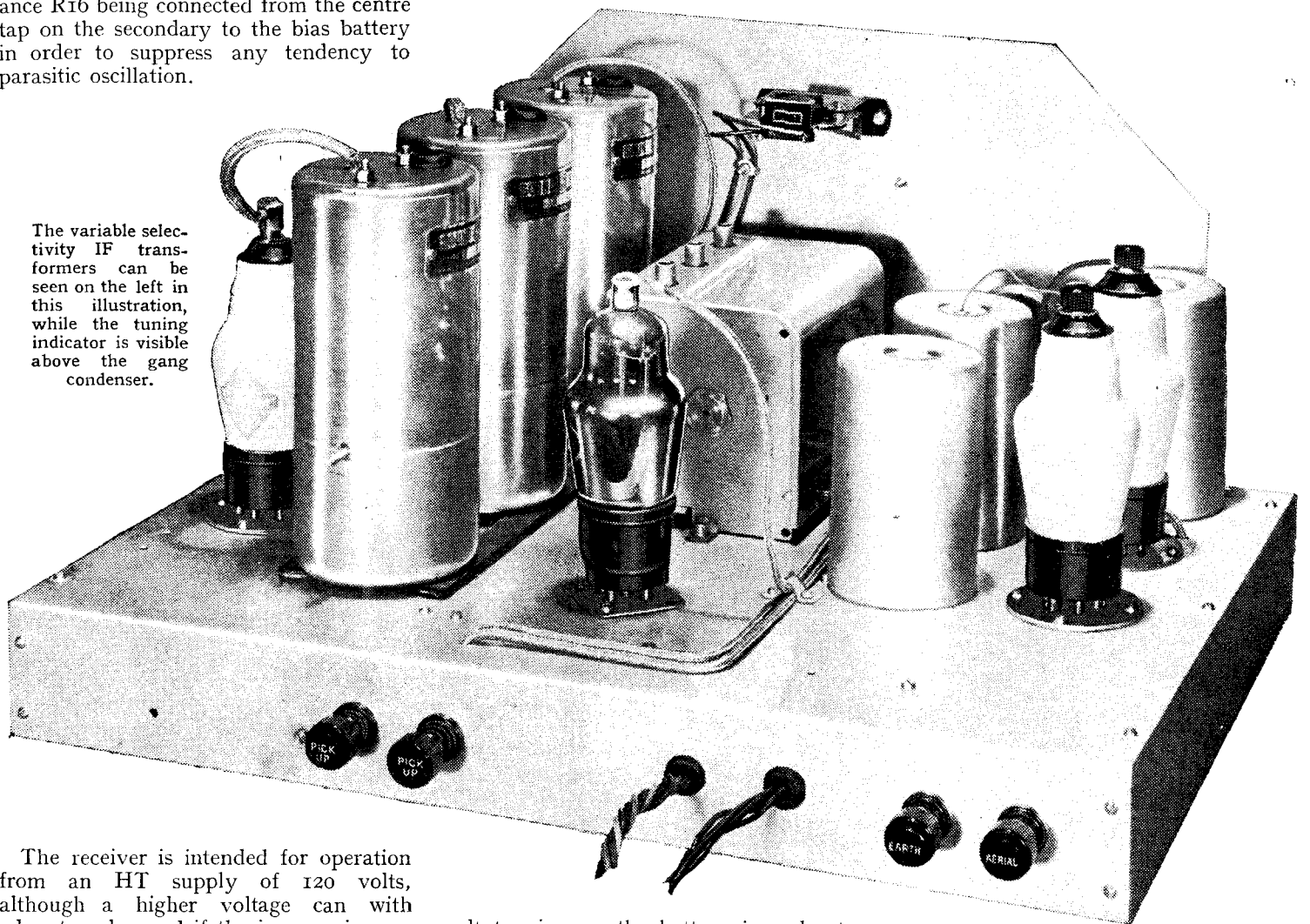

volt tapping on the battery in order to avoid the waste of current which would occur if a voltage divider were to be used.

A double-pole switch S9 is included to break both the HT and LT circuits, and

apparatus may usefully be given at this stage. The loud speaker must be fitted with a push-pull transformer having a low resistance primary and a suitable ratio to present a load of some 12,000

The 1936 Battery Monodial Super—
ohms to the output stage. This comparatively low value of load is, of course, necessary in view of the use of two QPP valves in parallel, for the load required is then one-half of that needed by a single valve. The total filament current consumption is 1.4 amperes at 2 volts, and a large-capacity accumulator is recommended. Nothing smaller than 20 a.h. (at the 20-hour discharge rating) is likely to be satisfactory over a long period, and

an accumulator of 30 a.h. is recommended.

For the HT supply, also, accumulators are advised, since with no signal the total current consumption at 120 volts is about 33 mA. It is impossible to state with any certainty the consumption on a signal, for when the set is tuned to a station there are two conflicting factors tending to alter the current. In the first place, AVC increases the grid bias of the first three valves, and so reduces their anode current consumption by an amount which depends on the signal strength. Secondly, the anode current of the output stage increases during modulation, and the louder the volume at which the set is worked the greater the current drain. It is probable that under average conditions of use the average current consumption is of the order of 30 mA., but the momentary currents during deep modulation are, of course, heavier.

It can be seen, therefore, that if dry batteries be used, only the largest capacity are likely to stand up to the drain, and accumulators are to be recommended. This advice is given not only from the point of view of obtaining the most economical power supply, but with the object of ensuring that the best results are secured. Although a dry battery will give as good results as an

accumulator when new, its internal resistance will rise after a time, even although the voltage may still be adequate for operating the receiver. This high internal resistance seriously affects the quality of reproduction with a quiescent type of output stage, and when the best performance is desired the battery must be discarded before its voltage has dropped to any great extent. A change from a partially run-down dry battery to an accumulator produces a very marked improvement in the quality. This is not to say that dry batteries are unsuitable, only that where facilities are available for the ready recharging of accumulators the latter are likely to be the more economical in the long run.

It is this question of the internal impedance of the HT supply which militates against the use of an HT eliminator. Apart from there being no point in using a battery-type receiver when mains are available, it is definitely disadvantageous to operate a QPP stage from an eliminator. Unless the mains unit is so generously designed as to be uneconomic, severe distortion is likely to be encountered. The 1936 Battery Monodial is designed for battery operation. If mains are available, a mains set should be built. Next week's instalment will contain full constructional details.

THE LIST OF PARTS

RECEIVER UNIT.

- 1 Three-gang condenser, 0.0005 mfd., C3, C6, C9
Utility "Mite" 347/3
(Polar, J.B.)
- 1 Tuning dial assembly, drive and escutcheon
Formo "Snail"
(Polar, J.B., Utility)
- 3 Variable-selectivity IF transformers, 465 kc/s
Sound Sales 465/VFT
(Wearite)
- 3 Trimmers, 0.0003 mfd., C8, C12, C13 Sound Sales 3VC
- 1 Aerial coil Bulgin C6
- 1 HF transformer Bulgin C7
- 1 Oscillator coil, 465 kc/s Bulgin C59
- Fixed Condensers.**
- 4 0.0001 mfd., C7, C10, C22, C23 Dubilier 665
- 2 0.0002 mfd., C1, C21 Dubilier 665
- 1 0.0003 mfd., C11 Dubilier 665
- 1 0.001 mfd., C14 Dubilier 670
- 1 0.015 mfd. tubular, C25 Dubilier 4502
- 10 0.1 mfd. tubular, C2, C4, C5, C15, C16, C17, C18, C19, C20, C24 Dubilier 4503
(Ferranti, Graham Farish, Peak, Polar-N.S.F., T.C.C., T.M.C. Hydra)
- Resistances, ½ watt.**
- 4 2,000 ohms, R2, R5, R6, R9 Ferranti G.5
- 3 20,000 ohms, R1, R3, R7 Ferranti G.5
- 1 50,000 ohms, R11 Ferranti G.5
- 2 100,000 ohms, R4, R8 Ferranti G.5
- 1 250,000 ohms, R10 Ferranti G.5
- 1 1 megohm, R13 Ferranti G1
- 1 2 megohms, R14 Ferranti G1
(Amplion, Bryce, Bulgin, Dubilier, Erie, Graham Farish, Claude Lyons, Polar-N.S.F., Watmel)
- 4 Valve holders, 7-pin Goltone R20/721
- 1 Valve holder, 5-pin Goltone R20/521
(Belling-Lee, Clix)
- 1 10-way connector Bryce
- 1 5-way cable assembly, 50in., complete with plug Goltone
- 1 5-way cable with wander plugs and spade ends, 30in. Goltone "Court" R59/385
- 1 Magnetic visual tuning meter Bulgin VT50
- 4 Ebonite shrouded terminals, A., B., Pick up (2) Belling-Lee "B"
- 1 Tapered volume control, 1 megohm, R12 Ferranti PG
- 5 SPST switches, S1, S2, S3, S4, S7 Bulgin S80B
- 2 SPDT switches (S5, S6), S8 Bulgin S81B
- 1 DPST rotary switch, S9 Bulgin S115
- 2 Lengths of rod, 9in. and 11in. for above Bulgin
- 2 Reducing sleeves for 5/16 in. shaft Bulgin
- 5 Knobs, 1/2 in. Bulgin K14B
- 1 Valve connector Belling-Lee 1175
- 2 Adaptors Bulgin P68
- 1 Cell, 1½ volts Siemens GT
- 3 Lengths screened sleeving Goltone
- 1oz. No. 18, 1oz. No. 20 tinned copper wire, 10 lengths Sistoflex, etc.
- Metal chassis, 16 x 12 x 2in., complete with screws, nuts and washers C.A.C.**
- Valves:—**
- 3 210VPT 1 210PG Cossor
- 1 1D22 Osram or Marconi

OUTPUT STAGE

- 1 Push-pull transformer, 1:3.5 Ferranti AF5c
- Fixed Condensers.**
- 1 1 mfd., 500 volts DC test, C26 Dubilier BB
- 2 0.005 mfd., C27, C28 Dubilier 670
(Ferranti, Graham Farish, Peak, Polar-N.S.F., T.C.C., T.M.C. Hydra)
- Resistances, ½ watt.**
- 1 150,000 ohms, R16 Ferranti G.5
- 1 25,000 ohms, R15 Ferranti G.5
(Amplion, Bryce, Bulgin, Erie, Graham Farish, Claude Lyons, Polar-N.S.F., Watmel)
- 1 Valve holder, 5-pin Goltone R20/521
- 2 Valve holders, 7-pin Goltone R20/721
(Belling-Lee, Clix)
- 1 3-pin plug and socket Belling-Lee 1119
- 1 9-volt grid bias battery
- 1 Pair grid bias clips Bulgin 1
- 2 Wander plugs Ealex
Small quantity No. 18 and 20 tinned copper wire. 2 lengths Sistoflex, etc.
- Metal chassis, 8 x 6 x 2in., complete with screws, nuts and washers C.A.C.**
- Loud Speaker, with QPP transformer, for 12,000 ohms load Goodmans "Grille" PM M/C**
- Valves, 2 QP21 Marconi or Osram**
- 1 Cabinet C.A.C.
- 1 2-volt 30 ah. accumulator Fuller SWXH7
- 1 120-volt HT accumulator Hilnes Super Capacity

Distant Reception Notes

THE test transmissions of the 120 kilowatt P.T.T. station at Paris have sufficed to show that it will be an excellent provider of programmes for a large part of this country when it takes over the regular service, probably very shortly after these notes appear. The Poste Parisien, using only 60 kilowatts, is a consistent and reliable daylight station in south-eastern England and the Midlands; the P.T.T. station with double the output rating and the most up-to-date of anti-fading aerials should cover a still larger area at all times and seasons.

Has any reader picked up Addis Ababa? I hear that a broadcasting station has been at work in the Abyssinian capital and that quite good reception has been obtained in this country. Personally, I have not logged this station and I have not so far been able to find out upon what wavelength it is working. It appears that a fully equipped broadcasting station of considerable power has been in the possession of the Abyssinian Government for some little time, but no use has hitherto been made of it since the native owners of receiving sets could probably be numbered with something to spare on the fingers of one hand. In the present crisis the Abyssinian Government is making use of the station in order to make its case known in foreign countries. Short-wave transmissions have been made with a 2-kW. plant using a call sign ETA on a wavelength of 39.3 metres.

The former Radio L.L., now styled Radio Cité, is at work again, after an interval of silence, on a wavelength of 280.9 metres. It may be heard in this country on particularly good evenings, though I have my doubts, partly because the Russian station

Tiraspol is already using that wavelength, and partly because it is sandwiched in between the 20-kilowatt Bari on the one side and the 30-kilowatt Bordeaux-Lafayette on the other. Radio L.L. can probably claim to be the Senior Nuisance amongst European stations owing to its wavelength-wandering habits in times gone by. Whether it will become a reformed character under its new name we shall see as the weeks pass. Unless the recent reconstruction of its plant has included the addition of some effective means of frequency control, I should be prepared to lay longish odds that its record in the next U.I.R. report will be very far from the ideal straight line.

Those who are interested in medium-wave Transatlantic reception should make a note of WJR of Detroit, Michigan, which has increased its power during the summer from 10 to 50 kilowatts. The station works on 400 metres and, if wireless conditions during the present sunspot cycle resemble those of the last, this wavelength should provide good reception in our country either this coming winter or next year. I confidently expect to find that stations in the United States and South America using wavelengths above 300 metres are better and better received over here during the next six months. For a long time now the best band of wavelengths for Transatlantic reception has been that between about 220 and 300 metres, but references to my logs of 10 years and 11 years ago show that stations on wavelengths up to nearly 500 metres then became better heard. Should conditions for long-distance reception follow their expected course we should shortly have splendid reception from the 500 kilowatt WLW, which works on 428.5 metres.

D. EXER.

The Development of the Forty Years' Progress Wireless Aerial

BY COMMDR. J. A. SLEE, R.N. (Ret.), C.B.E.

IF we omit all reference to the original laboratory experiments with Hertzian rays, and to other methods of telegraphy without the means of connecting wires, we can simplify the history to that of the work which has been done during the lifetime of Marchese Marconi, whose early work originated the great

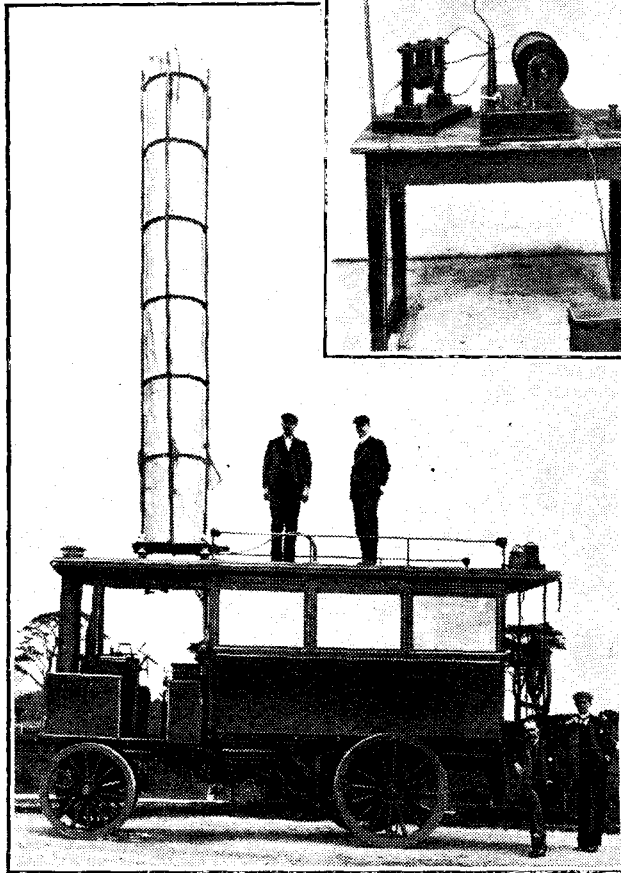

A "field day" thirty years ago. Marchese (then Mr.) Marconi is standing beside Sir Ambrose Fleming, seated on the bus step.

majority of the advances which have been made, and has inspired most of the rest.

The first transmitting and receiving aerials were very much of the nature of the Hertzian dipole, two good-size metal sheets a short way apart with a straight conductor between them broken in the middle by a small spark gap. It was soon found that one half of this arrangement could be replaced by the surface of the earth. It is a common legend that this discovery was accidental, though

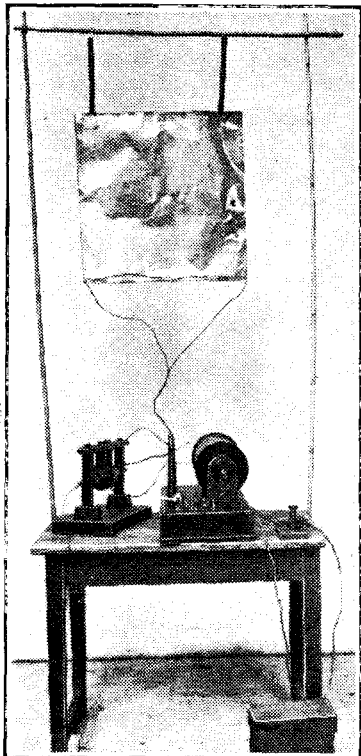

Marconi's earliest form of aerial—a metallic sheet connected to a spark gap.

this does not seem to be very likely.

The next phase was to use a slightly elevated conductor of comparatively large capacity, first a flat vertical sheet, and later a cylinder, only a short distance above the surface of the earth.

Then came an important step forward, when the proper value of height began to be realised, and aerials began to take the form of

a small cylinder of wires, hoisted as high up as possible. Kites were also used to carry a single wire to a greater height. We reach about the year 1896, with aerials of this nature, and "plain aerial" transmitters, mostly simple 10-inch spark coils.

The long series of experiments with the object of transatlantic communication was then commenced.

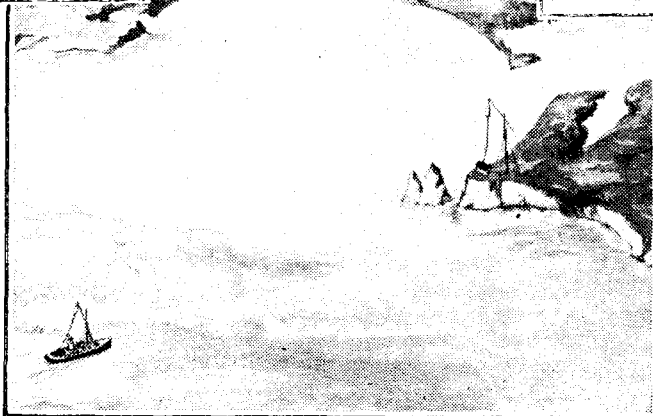

Elevated cylindrical aerials were first used at the Needles station, Isle of Wight. Kite aerials were also experimented with.

In these days of high amplification the receiving aerial gets less attention than it did even a few years ago, when every millivolt was precious. On the transmitting side, however, research still goes on to discover increasingly efficient methods of radiation. In this, the first of a series of articles, the author discusses aerials prior to 1914.

The first transmitting station was at Poldhu, and the first aerial used was a large skeleton cylinder about 200 feet high and 150 feet in diameter. There were about 2,000 vertical wires. A good deal of this was blown down and experiments were continued with a more or less fan-shaped arrangement of single wires. A similar but smaller aerial was erected between the masts of a ship for receiving. The results obtained allowed considerable advance to be made, and a form of aerial construction was developed for the transmission of long waves which only differs in size and in detail from the most recently built aerials for the same purpose. This form consists of a number of parallel horizontal wires supported as high as practicable above the ground, thus forming a kind



of skeleton ceiling. At this time the greatest height regarded as practicable was about 200 feet, wooden masts being considered indispensable.

Experimental work on aerials of this nature brought into notice the

The Development of the Wireless Aerial—directional properties of a long and low aerial both for transmission and reception. The directional results were found to be sharp enough to allow bearings of a sort to be obtained by using a set of such aerials erected radially round the receiving station, and switching the receiver to any one of them, the direction being determined by the aerial which gave the loudest signals.

The increase of power available, and larger aerials, had made long distance communication fairly certain with strength sufficient to permit the use of the type of measuring instruments which were then

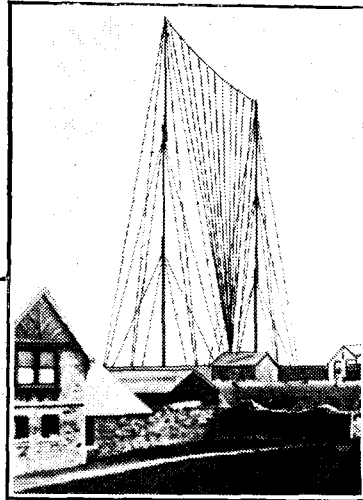
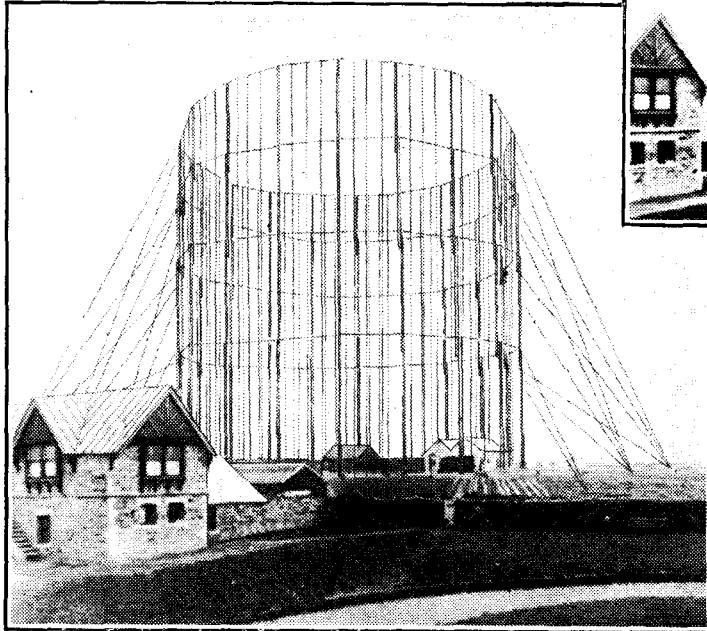

Two early views of the transatlantic station at Poldhu, showing the first and then a later aerial arrangement.

War. During this period the three-electrode valve came into being, though it was not until well into the War that its use became general.

About twelve masts, a height of 400 feet was available. Aerial about 1,200 yards long and 300 yards wide. Older stations had much smaller aerials of about the same proportions. These aerials had considerable directional properties.

Alternatively, a single central support about 800 feet high, carrying an umbrella aerial, the outer points of which were about 400 feet from the mast and 400 feet above ground.

Transmitting aerials for small land stations consisted of two masts about 150 feet high and 300 feet apart.

Generally two or four wires about 12 feet apart were hoisted as high as possible between masts. Men-of-war were then using most elaborate structures, the aerial being in two parts, each consisting of a skeleton cylinder about 4 feet

in diameter. These were often continued about half-way down to deck abaft the mainmast.

The earliest experiments had been carried out with waves of fairly high frequency, but with the apparatus then available, especially for reception, a progressive improvement in performance was found as the frequency was reduced. Hence the demand for enormous aerials for use with long wave spark transmitters at large stations on land intended for telegraphic communication with similar stations at great distances. Waves of higher frequency than 1,000 kilocycles per second were considered to be of very little use for any purpose, and the very big stations using aerials such as described were designed for waves having frequencies between 15 and 30 kilocycles.

At this period there was no telephony service and no aircraft wireless. Practically all wireless was confined to high power point to point communication, and communications with and between ships.

Transmission was by spark and reception by magnetic detector, or by carborundum crystal. Electrolytic detectors had become the fashion, and had in turn given way to carborundum or other forms of crystal rectifier.

It was the practice to separate the receiving and transmitting apparatus by a considerable distance, twenty or thirty miles, at all important stations. The receiving aerial was a very long single wire, arranged so as to give its maximum efficiency of reception in the direction of the wanted signal and its minimum in the direction of the transmitting buildings.

The actual telegraph work was usually carried out at the receiving building, the transmitter being distance-operated through a land telegraph line.

(To be continued.)

available so that quantitative results could be obtained, and the mathematical and physical study of the propagation of waves and the properties of aerials of different forms could be commenced. These researches led to the identification of the existence of the ionosphere associated with the names of Heavyside and Kennelly.

The aerial construction for use in long-distance stations on land was developing in two directions, first, the large, flat-topped structure supported on many masts, and giving a definite directional effect, and, secondly, the construction of an aerial not unlike the ribs and stick of an umbrella, the central support being a great deal higher than the masts supporting the flat-topped formation. These high umbrella-type aerials had no trace of directional transmission.

The Pre-Valve Era

All the aerials of this period were essentially of large capacity so as to reduce as far as possible the enormous peak voltages generated by powerful spark transmitters.

The Poulsen arc had appeared, but it was not in extensive use, the chief difficulty being the lack of suitable receivers. Even when the best method of reception was introduced, the practical difficulties of carrying it out were almost insuperable,

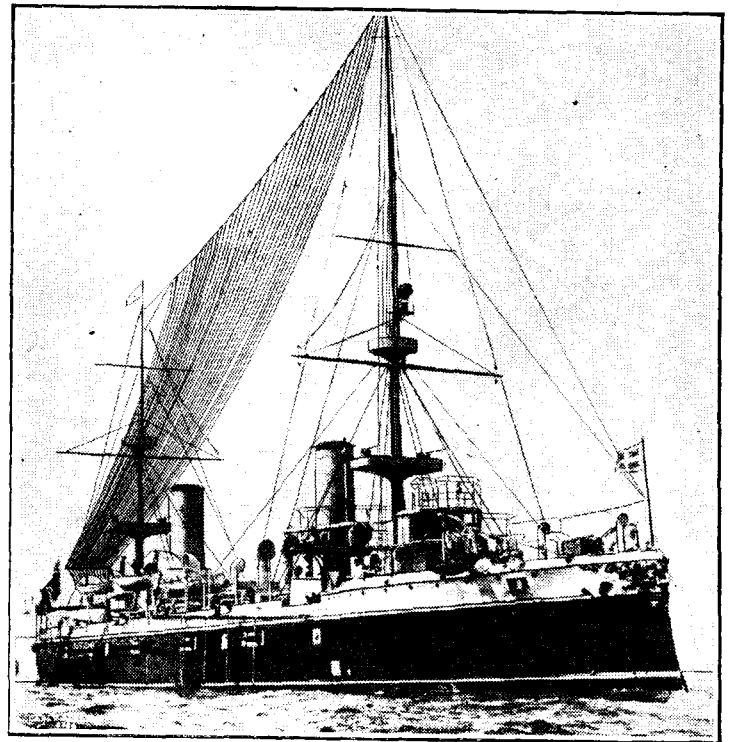

One of the first ship aerials—on the Italian warship, "Carlo Alberto."

UNBIASED

Radio Maximo Arvo

WHEN we become rich or famous one of our first thoughts is to enhance our dignity by taking unto ourselves a coat of arms complete with crest and Latin motto, not forgetting the one guinea annual licence. The settling of the exact details of our armorial bearings is often very difficult, more especially the motto, and I well remember the sleepless nights I spent in my own case; indeed, I haven't settled the question of the motto even yet and am still open to suggestions.

Much ingenuity is often shown in arriving at really appropriate mottos, and a classic instance of this is the member of the great Smith tribe, who, having won his way to fame and fortune by his own efforts, took unto himself the exceedingly apt motto of *Faber Meæ Fortuneæ*. Nobody has, as yet, sought to immortalise himself



Consulted all the best Latin dictionaries.

by taking his own initials and using them as the initial letters of the words of his motto, at least nobody had done so until comparatively recent years when it fell to a great trade association connected with wireless to achieve this honour.

I must confess that I have often wondered at the apparent lack of meaning in the famous motto of the Radio Manufacturers' Association, viz., *Radio Maximo Arvo*. One of the beauties of Latin mottos, of course, is that you can twist the meaning of words into almost anything in order to suit your own fancy, as witness the B.B.C.'s efforts in the foyer at Broadcasting House. But there is surely a limit. A very long time ago when I first enquired of a R.M.A. official what precisely was the meaning of his association's motto, his reply—"Broadcasting to the farthest shore"—was a little unconvincing, and yet I learned afterwards that this is the official translation. I cannot see how on earth they manage to squeeze the word "Broadcasting" out of this piece of Latin doggerel. What is the Latin for "Broadcasting," anyhow? I have consulted all the best Latin dictionaries and they fail to help me. The translation of the word "Maximo" as "farthest" is to say the least of it a bit thick, but "Arvo" we must definitely concede as meaning "shore."

It was not until a kindly member of the R.M.A., to whom I made my complaint recently, took me gently by the hand and pointed out that the initials of the Latin motto and of the Association's name were identical that I began to see the light; in fact, I may say that everything is as clear as daylight now, and I silently remove my headgear in admiration of true genius.

Cruel Aspersions

MANY people have written to me asking why my usual report of the Olympia show has failed to appear this year, and several have made the unworthy suggestion that at last I have sold my soul to the manufacturers and have agreed to withhold my usual criticisms.

In reply to such base and ungrateful suggestions I can only refer to my record of the past five years, during which I have again and again championed the cause of my friends, the great radio public, against their arch-enemies. In view of this evidence of character I do earnestly ask whether anyone seriously thinks that I am the sort of person who would willingly and knowingly sell myself to the enemy.

As a matter of fact the reason I did not write about the show was that, for the first time for many years, I was prevented from visiting it owing to a nasty attack of gout and I have, for the past few weeks, been compelled to do my share of the world's work in the privacy of my home. My distressing malady was due, so my medical adviser informed me, to my having got extremely damp at the Naval Review held last July, although whether he was referring to dampness within or without he did not say.

The Chameleon Touch

THERE seems to have been a tremendous epidemic of miniature portable sets this year, both loud speaker and otherwise. Without exception, however,



In the semblance of a bookmaker's satchel.

they all suffer from the same fault, namely, that of outlandish appearance. If there is one thing more than another which the average man hates it is to make himself look ridiculous, and once the manufacturers learn to make their small

headphone portables look like ordinary attaché cases instead of the attention-compelling objects they are at present, they will, for a change, find themselves on the Promenade des Anglais instead of Carey Street.

By FREE GRID

Being personally of a very sensitive and refined nature, I have long since adopted the policy of using a portable receiver suited to my surroundings. I have actually several of these instruments. For instance, I have one made up in the semblance of a bookmaker's satchel which I invariably take to the race meetings, while the one which accompanies me on trips to Southend resembles an outsize in beer bottles, the tuning knobs being shaped like whelks. I can see no reason why manufacturers should not follow my example; a receiver shaped like a cricket bag for Test Match enthusiasts, and a Charwoman's Portable in the shape of a bucket and mop would be invaluable, while every housewife would welcome a set in the form of a string shopping bag, the valves made to represent brussels sprouts.

Record Changers

IT is astonishing that, in spite of the fact that they have been with us many years now, automatic record changers are not fitted as a matter of course to all radiogramophones. In an endeavour to find out the reason why their use was not more universal I consulted a well-known dealer, and he stated that, in his view, there was one very cogent reason. This reason was, he said, that, with the exception of one make, none were provided with a lever whereby the automatic mechanism could be cut out when desired, and he could not understand why manufacturers of these articles did not make this simple improvement.

Personally, I am inclined to think that there is a second reason and that it is wrongly thought that an inexpensive double-sided instrument is likely to be marketed shortly, and thus radiogramophone manufacturers hesitate to fit the single-sided instrument to their models. This, I think, is absurd, as such an instrument must, of necessity, be so much more complicated and therefore costly as compared with a single-sided instrument as to take it completely out of the field of competition. There was only one double-sided record changer shown at Olympia this year, and, delightfully simple as I am told it was, it could obviously be produced for nowhere near the price of a single-sided instrument.

Personally, I think it is a great pity, as, in my experience, the automatic record changer makes a radiogramophone really worth having. What do you think?

Events of the Week in Brief Review

Radio-Normandie

REQUESTED by the French Government to move to another site, Radio-Normandie has chosen a high plateau between Caudebec and Yvetot. The studios will remain at Fécamp.

Transmitters' Privilege

ALTHOUGH the Amsterdam City Council has decreed that all wireless poles shall be removed from the city roofs, a concession is to be granted to amateur transmitters. It is realised that they cannot efficiently carry on short-wave experiments with only indoor aerials, and accordingly they are permitted to retain the outside variety.

Portables on the Alps

TO test the efficiency of their emergency apparatus for field work, Swiss amateurs held a Mountain Field Day on Sunday last, September 22nd. Portable transmitting apparatus was taken on to the Alps, and in spite of the serious screening effects of the mountains, communication was maintained not only between the various cantonments, but also with many foreign amateurs on 42 and 84 metres.

Watching the Commercials

TO prove to the Cairo Radio Telegraphic Conference that commercial operators do not make full use of their available wavelengths, amateur radio societies throughout the world are now making arrangements for a continuous check to be kept on a number of commercial stations operating on channels adjacent to the popular amateur 42-metre band. It is hoped that the Cairo Conference will be persuaded to grant amateurs a wider frequency band in this region.

U.S. Railways Say "No"

DO railway travellers enjoy radio reception? The question is being hotly debated in America, and three of the largest eastern railroads, viz., the New York Central, the Baltimore and Ohio, and the Pennsylvania, have answered with a negative. They have, in fact, agreed not to equip any of their trains with radio except for an occasional big "hook-up" such as a National Election or vital baseball match. The railways declined to fit wireless sets on their trains for President Roosevelt's recent address to the Young Democrats.

Current Topics

News from the Tape

A RECORD broadcasting centre has just been opened by the French Post Office in the Rue Francois 1er, Paris, with steel tape apparatus for the transmission of three editions of the P.T.T. radio journal each morning at 7, 8 and 9 o'clock. At the request of listeners certain records can be repeated.

French Television Move

IS France stealing a march on Britain in the television field? Within six months Paris is to have a 180-line television service operating on a wavelength of 7 metres from the summit of the Eiffel Tower. In an official announcement last week M. Mandel, the French

ing from notes rather than prepared text. He would begin with: "This is Huey P. Long, United States Senator from Louisiana, speaking," and then urge his listeners to 'phone their friends telling them he was on the air and to tune him in, "because I am not going to say anything very important for a few minutes anyhow." Every five minutes or so he would repeat "This is Huey P. Long speaking," as he was anxious that late tuners-in should make no wrong guesses.

One of his late-night broadcasts drew over 100,000 letters.

Stoke's Radio Week

FROM October 7th to 12th Stoke-on-Trent will hold a "radio week" with a radio ex-

demanding a substantial reduction in the cost of electricity, invites communications from readers who are interested in this matter. The address of the Association is Windsor House, 46, Victoria Street, London, S.W.1.

Anti-Static War in Austria

A STAFF of 450 persons is now employed by the Austrian broadcasting authorities to trace interference with radio reception, and 300 cars have been fitted with interference detection devices.

Early Risers

THE imminent return of dark winter mornings is raising the question as to which are the earliest risers among European broadcasting stations. The Germans still appear to hold the record as some of their transmitters begin functioning at 5 a.m. On certain days Konigsberg is "up" at 4.58 a.m. Breslau begins at 5, Hamburg 5.40, and Leipzig at 5.50.

Other European stations take the plunge as follows:—Riga, 5.55; Prague, 6.30; Vienna, 7.15; Luxembourg, 7.30; Rome, Milan and Hilversum, 7.45. Radio-Paris opens at 6.45 on week-days, and Poste Parisien wakens its listeners with a bugle call at 7.10.

A Radio Leash

JUST when juvenile emancipation appears to have reached its zenith, in steps radio to place a new curb on infant liberty. The first victim is five-year-old Jean Darlington, daughter of an engineer of the American G.E.C. Her joy-cart, in which she would fain take her dolls for a walk, is occupied instead by a short-wave receiver permanently tuned to her father's amateur radio station. Jean trundles the cart about the neighbourhood always with an ear cocked towards the loud speaker for parental instructions to return home immediately.

As the picture on this page shows the device would be eminently suitable for use by the adult population, especially husbands "detained at the office."

U.S. Amateur Activity

ACCORDING to a census recently taken by the American Radio Relay League, 96 per cent. of amateur transmission activity in the U.S. takes place on the four lowest frequency bands, namely, 160, 80, 40 and 20 metres. The remaining 4 per cent. is almost wholly on the 5-metre band.

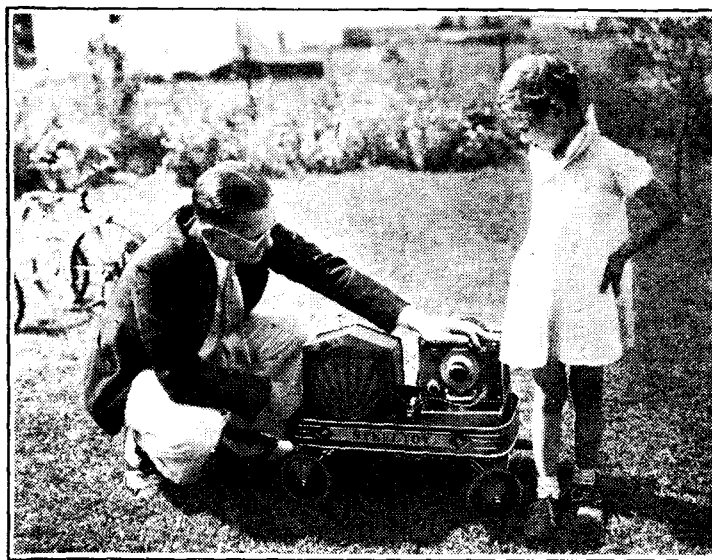

"AND EVERYWHERE THAT MARY WENT." The nursery rhyme has a new interpretation in America, where 5-year-old Jean Darlington, daughter of a G.E.C. engineer, trundles around this short-wave set for the reception of minute-by-minute advice and instruction from her fond parents.

Postmaster-General, stated that good reception should be enjoyed throughout the entire Paris region.

In the meantime, test transmissions are to begin on November 10th next with the object of assisting the French radio trade to design and construct suitable receivers in readiness for the opening of the service.

A Unique Broadcaster

THE late Senator Huey P. Long's radio talks are stated to have drawn "more tangible reactions" than those of any other American broadcaster with the possible exception of Father Coughlin.

Before the microphone he had a style of delivery all his own. Whether standing or sitting he would gesticulate freely, speak-

ing from notes rather than prepared text. He would begin with: "This is Huey P. Long, United States Senator from Louisiana, speaking," and then urge his listeners to 'phone their friends telling them he was on the air and to tune him in, "because I am not going to say anything very important for a few minutes anyhow." Every five minutes or so he would repeat "This is Huey P. Long speaking," as he was anxious that late tuners-in should make no wrong guesses.

Trouble in Algiers

ALGERIAN listeners are reported to be rebelling over the decision of the local postal authorities not to increase the power of Radio Algiers. Listeners contend that as they pay licence fees the money should go to the improvement of the transmitter, whereas the funds have been "swallowed up in the gulf of the general budget."

Radio Algiers shares its 318.8-metre wavelength with Göteborg, Sweden, and employs a power of 12 kilowatts.

Cheaper Electricity

THE Electricity Consumers' Association, which has been formed with the main object of

Practical QAVC Circuits

Automatic Suppression of Signals Below Threshold Strength

By J. H. REYNER, B.Sc., A.M.I.E.E.

A clear explanation of the requirements of a "Quiet" Automatic Volume Control device, with a description of various practical valve-operated systems, and a discussion of their relative effectiveness under working conditions.

THE requirements of a quiet automatic volume control or muting circuit are simple, although their fulfilment is not always so easy. In brief, we have to arrange:—

(a) That the loud speaker shall only be operated with a signal capable of giving good programme value.

(b) That the normal operation, and particularly the quality of the receivers, shall not be impaired by the addition of the muting.

Muting is usually arranged by introducing an extra valve into the circuit in such a manner that the low-frequency amplification is temporarily interrupted until such time as the detector receives a carrier of adequate strength. The system is, of course, operated by the voltage developed at the detector in similar manner to the usual automatic volume control, although,

ing condition was too gradual, and, moreover, the quality was distorted around the transition point, so that a weak signal just capable of releasing the LF valve was still not of programme value on account of the quality. A further disadvantage was that the effective amplification of the low-frequency stage was less for weak signals than for strong, which is the reverse of the requirements.

The Relay System

The ideal form of control is probably a relay with a small backlash. This can completely isolate the output valve until the critical signal strength is reached, when the relay armature pulls over with a snap. The circuit will then remain operative even though the signal strength falls slightly below the critical value due to fading, but as soon as the carrier drops appreciably

Here a double diode-triode is used for the detector, operating in the normal manner except that a separate muting triode is connected in parallel, drawing its current through the same anode resistance R . With no input this muting valve has a positive bias on its grid due to the voltage drop on the cathode resistance R_1 in the cathode lead of the DDT. Consequently, V_2 takes a large

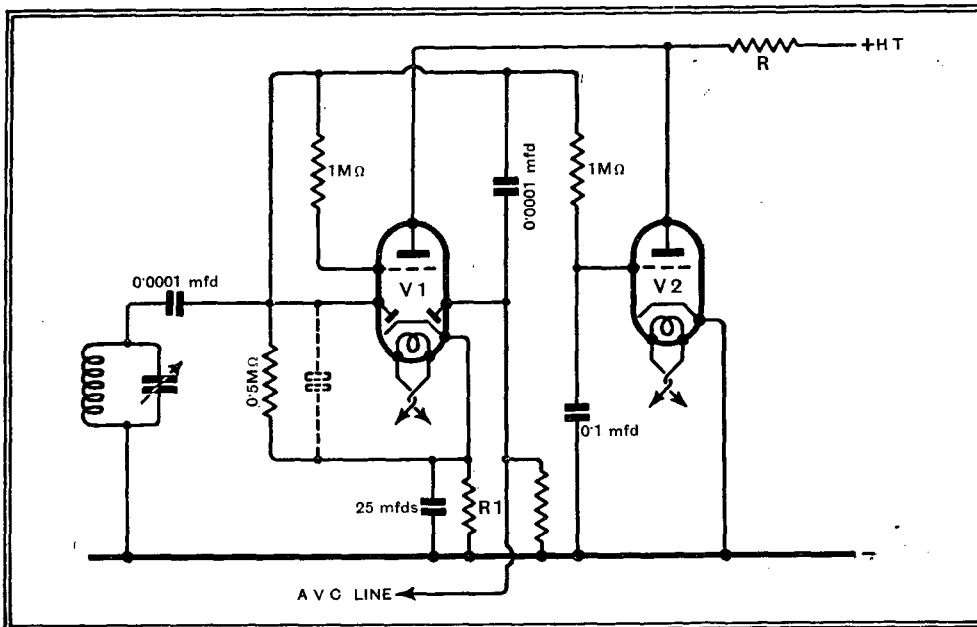

Fig. 1.—A fairly successful QAVC circuit which well illustrates the principle of valve control.

as we shall see later, it is not always desirable to operate directly off the AVC line. Once the carrier voltage has reached the predetermined limit the low-frequency valve must come into operation definitely and swiftly.

The early attempts were in the direction of over-biasing the LF or output valve, but this did not always prove satisfactory. The change from the inoperative to the work-

ing condition was too gradual, and, moreover, the quality was distorted around the transition point, so that a weak signal just capable of releasing the LF valve was still not of programme value on account of the quality. A further disadvantage was that the effective amplification of the low-frequency stage was less for weak signals than for strong, which is the reverse of the requirements. A relay to perform the operation successfully and reliably, however, is inclined to be somewhat expensive, and attempts have been made to obtain satisfactory results with valves on the score of cheapness. A form of circuit which is rather more successful than the simple over-biased arrangement is that shown in Fig. 1.

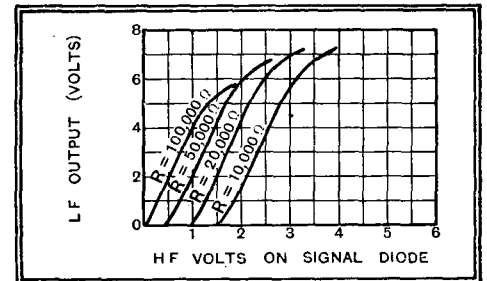

Fig. 2.—Effect of varying the resistance R of Fig. 1. Cathode resistance, 5,000 ohms; in this and succeeding curves, modulation is fixed at 50%.

anode current, causing a heavy voltage drop across R . V_1 has no bias, and thus also takes a fairly heavy current, causing a further reduction in the anode voltage, so that the gain of the triode section of V_1 is very small.

On the arrival of a signal, however, negative voltage is developed across the diode resistance, causing the grid voltages of both V_1 and V_2 to run back. The anode current of both valves falls rapidly with corresponding increase in the anode voltage, allowing V_1 to function normally.

The operation of this circuit is controlled by the value of the resistances R and R_1 ,

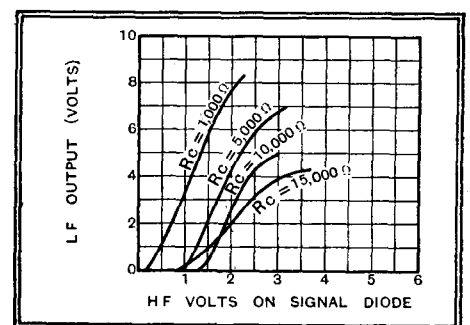

Fig. 3.—How the operating point and cut-off are affected by varying the cathode resistance (Fig. 1). Anode resistance, 20,000 ohms.

Practical QAVC Circuits—

and with correct choice of these quite effective performance is obtainable. Fig. 2 shows the effect of varying the anode resistance R, keeping the cathode resistance constant at 5,000 ohms. It will be observed that a sharp cut-off is obtained, and that

This is because the negative voltage required to cut off the bias is so large that the DDT begins to operate even with the small HT voltage available. Under such conditions the amplification is by no means distortionless, and, in fact, the condition is not a practicable one.

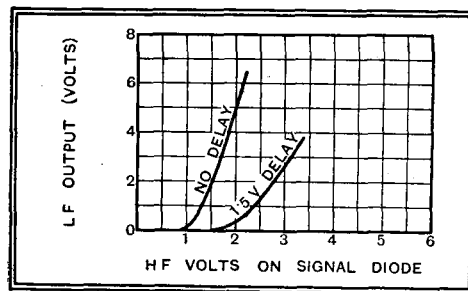

Fig. 6.—Muting becomes ineffective if too large an anode resistance is used. Conditions as in Fig. 5 ; screen voltage, 45 volts.

this is not the case. Practically all the muting schemes which operate successfully have, in themselves, a delay action. If the application of the release voltage is itself delayed, the whole operation is held up for too long, and distortion results. It is much better to arrange the constants of the muting valve so that the delay is given by that valve itself and by making R or R₁ in Fig. 1 variable (not as a control but as a pre-set adjustment) the circuit can be arranged to release at any signal voltage within fairly wide limits. The 1-megohm resistance and 0.1-mfd. condenser in the grid circuit of V₂ are, of course, for decoupling to prevent the application of low-frequency signals to the muting valve. It should be pointed out that the choice of the AVC or the detector circuit for controlling muting depends very largely on the design of the receiver. The arrangement described here holds for the average set, but in receivers of high sensitivity, and particularly those incorporating an unusually effective AVC system, it may be better to control muting from the AVC circuit than from the detector.

A somewhat similar circuit is shown in Fig. 4. With this arrangement, however, the DDT valve is biased in the normal way and the control valve operates with zero bias instead of a positive bias. In order to obtain sufficient current an HF pentode is used instead of a triode since the anode current can be adjusted on such a

the point at which the circuit becomes operative can be altered by varying the value of the resistance. The delay is increased by reducing the value of R, which is, perhaps, the reverse of what one might

Arising out of this it will be clear that one disadvantage of this circuit is the gradual increase in the negative bias on the DDT with increasing signal, and if this continues too far the valve will begin to operate over the curved portion of the characteristic, with subsequent distortion, unless the triode is of the variable-mu type.

It should also be noted that the muting valve is operated direct from the signal diode and not from the AVC diode, which may (and usually does) operate with a delay. It might be thought that the customary delay on the AVC action would also be applicable to the muting valve, but

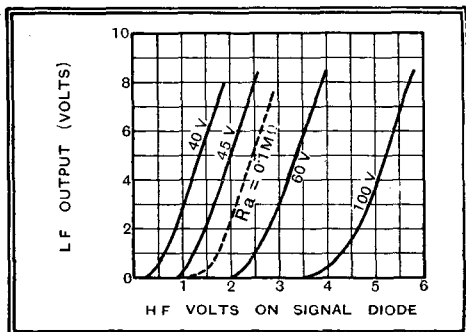

Fig. 5.—Showing that variations of anode current with the arrangement of Fig. 4 have comparatively little effect, but that the adjustment of screen voltage on the muting valve is quite critical. Anode resistance 250,000 ohms ; cathode resistance 15,000 ohms.

expect. It must be remembered, however, that the lower the value of R the greater the current through R₁, and, therefore, the greater the positive bias on V₂ which has to be overcome by the signal before the circuit can operate.

Fig. 3 shows the effect of varying the cathode resistance R₁ with the anode resistance constant at 20,000 ohms. It will be seen that this also enables the operating point to be changed, but that as the resistance is increased the cut-off becomes more gradual, and with 15,000 ohms the sharp division between operation and non-operation has been lost entirely. Increasing R₁ also limits the available LF output.

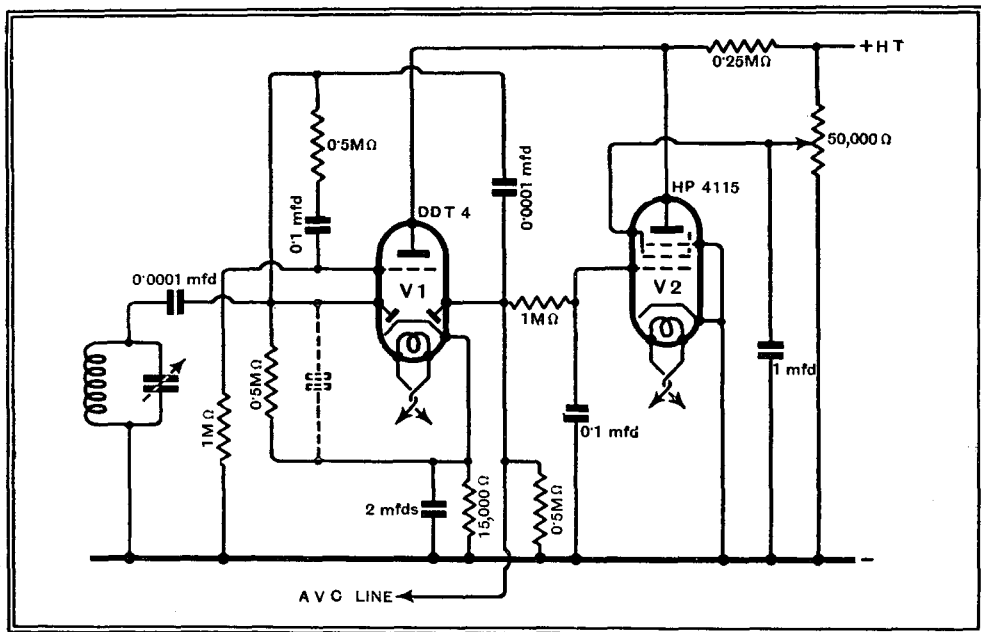

Fig. 4.—A QAVC circuit in which the control valve operates with zero bias.

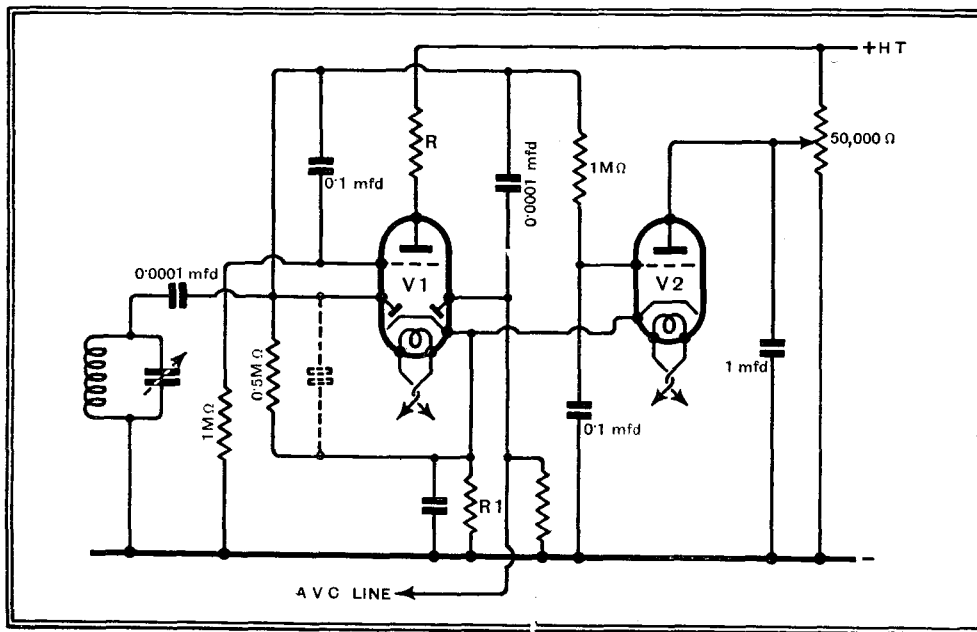

Fig. 7.—A control circuit combining the good points of Figs. 1 and 4.

Practical QAVC Circuits—

valve by variation of the screen voltage.

With this circuit the anode resistance is not so critical, and, in fact, as will be seen from Fig. 5, a large change in the value only makes a small alteration to the performance of the circuit.

Control by Screen Voltage

The important factor in this circuit is the screen voltage on the muting valve, which is quite critical and must be adjusted by a pre-set potentiometer to suit the particular requirements. Fig. 5 shows the performance of the circuit with various screen voltages. It will be seen that there is a fairly sharp cut-off, although not quite so sharp as with the previous circuit. The dotted curve shows the effect of reducing the anode load, and it will be seen that this produces a curvature at the bottom tending to spoil the sharpness of operation. The advantage of the independent bias on the DDT will be clear, since the limiting of the LF output is no longer present.

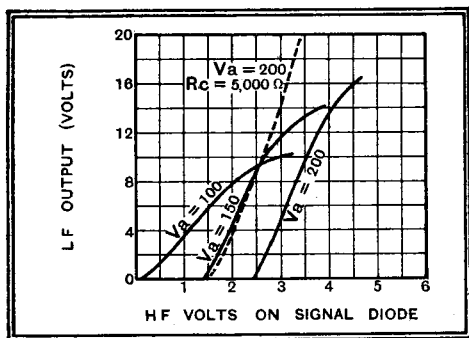

Fig. 8.—Effect of varying the anode voltage applied to the muting valve of Fig. 7. Anode resistance, 50,000 ohms; Cathode resistance, 15,000 ohms.

It will be noted that this particular circuit is operated off the AVC line, but the delay is only small because the DDT normally takes very little anode current owing to the action of the muting valve. As the signals build up the DDT takes more anode current and the delay (and the bias of the DDT grid) increases, and the circuit settles

down to its normal operation. At the same time, if the cathode resistor is made too large so that the delay is too great, the effectiveness of the muting is largely lost, as already explained. This is exemplified by the curves shown in Fig. 6.

The Tunggram Valve Company has evolved a circuit having the good points of both the previous arrangements; this is shown in Fig. 7. Here a triode is again used for the muting valve, but its operation is controlled by varying the voltage applied to the anode. The anode current of the DDT and the muting valve again go through a common resistance, but this is now included in the cathode lead, so that it also serves to increase the bias on the DDT. The result is that the release of the DDT is very sharp, as will be seen from the curves in Figs 8 and 9.

The cathode resistor must not be too large or the bias on the DDT is too great,

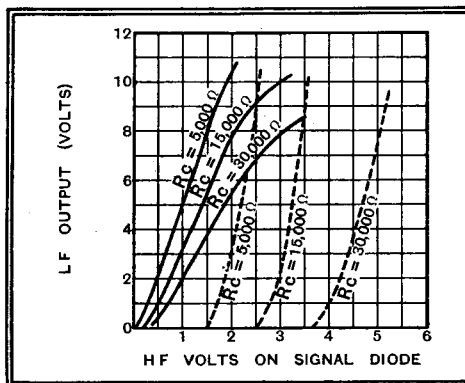

Fig. 9.—Performance with various values of cathode resistances. Anode resistance fixed at 50,000 ohms; anode voltage 100 (full lines) and 200 (dotted lines).

and the valve overloads easily. On the other hand, if it is too small, the control of the muting valve is only poor. With the values shown satisfactory operation can be obtained without difficulty. The control of the muting is by varying the HT voltage of the valve V_2 , which again can be a pre-set adjustment. Its control is not quite so critical as the screen voltage in the preceding circuit, and the arrangement will be found a satisfactory one in most circumstances.

Monitoring the Short Waves

A Brussels Chart for August

THAT the Brussels wave-checking station has undertaken a formidable task in measuring the frequencies of the world's short-wave stations is suggested by the fact that during August no stations under 25.40 metres were dealt with. A large number of new stations were measured on the 49-metre band.

Working up from 25 metres, we find a newcomer, Boston W1XAL, which started off on August 1st on 11,784 kc/s, but was discovered to be on 11,790 on the 12th, though it finished up near its starting point. Madrid EAQ was very erratic; after beginning on 9,863 kc/s, it had wandered to 9,842 towards the middle of the month, though by the 31st it was practically on its

allotted frequency of 9,860. Lisbon CT1AA, which had roamed between 9,590 and 9,630 kc/s in July, kept within 10 kc/s of 9,630 during August. Philadelphia W3XAU was steady, as were Daventry GSC, Springfield W1XX, Zeesen DJA and DJN, Schenectady W2XAF, Jely LKJ1, Daventry GSB, and Rio de Janeiro PRF5.

This brings us to the end of the 31-metre band. There is nothing more recorded on the charts until we find Radio Club Portugues CT1GO, near 6,180 kc/s on the 49-metre band.

Caracas YV3RC is commended for its steadiness, but Lisboa CSL was a little uncertain, wavering within 6 or 7 kc/s of its allotted wave of 6,150 kc/s. Wayne

W2XE seems to have eluded the Brussels policeman since the middle of July. Caracas YV2RC left its 6,115 for 6,106 kc/s, which it has to share with Manizales HJ4ABH. Bound Brook W3XAL is another old friend with a steady signal; so is Bowmanville VE9GW, which remained on 6,090 kc/s throughout the month. Nairobi VQ7LO is a newcomer on 6,083 kc/s.

Above 49.3 metres (Nairobi) there are few entries of importance. Radio Club Pernambuco PRA8 wandered over a band of 40 kc/s, being on 6,040 kc/s at the beginning of the month, then on 6,000 towards the 20th and in the neighbourhood of 6,025 on the 31st. Santa Marta HJ1ABJ on 6,004 and Santo Domingo HIX on 5,984 kc/s are newcomers to the Brussels graphs, which still contain a number of unidentified signals, especially on the 49-metre band.

No doubt as time goes on the Brussels wave-checking station will be able to bring the same efficiency and precision to bear on the short waves as it at present reserves for the medium and high wavebands.

Short-wave Broadcasting

RATHER curious short-wave conditions have been noticed during the last few weeks. The only way in which they can be summed up is by saying that certain wave-bands have been unaccountably bad, while others have remained normal.

On certain days, for instance, the American stations in the 19-metre broadcast band have been definitely poor, while American amateurs, using telephony in the 20-metre amateur band, have been coming in at tremendous strength.

This kind of selective "dud-ness," as a friend of the writer's has termed it, is one of the most puzzling features of short-wave reception, and is often responsible for reports of poor conditions when things are really quite normal except for one narrow band.

While on the subject of American amateur 'phone on 20 metres, it seems worth while to remark that many short-wave listeners whose sole interest, hitherto, was in the broadcast stations, have become completely converted to amateur-band listening by the tremendous popularity of telephony this year.

Without seeming detrimental to the British amateur, one cannot help saying that the American telephony one hears is of a tremendously high standard. Even "carbon-mike quality" is rarely heard, and such crimes as grid modulation do not seem to exist in the States! One naturally does not hear much British telephony on the 20-metre band, on account of skip-distance and the relatively small number of active stations.

Listeners to W3XL (Bound Brook) on 46.69 metres, during the remainder of this month, may be lucky enough to hear a relay of another stratosphere broadcast. An 8-watt portable station with the call-sign W-10 XFH will be taken up in the gondola of the stratosphere balloon, and the ground station, W-10 XFN, works on 47.24 metres. As both stations are reported as testing with W3XL, it seems probable that the latter station will relay anything interesting.

The "week-day Australian," VK3LR at

Lyndhurst, has been coming in consistently on 31.34 metres. This transmission is not as strong as that from VK2ME (31.28 metres) on Sundays, but it is regular and strong enough to be heard on any moderately good short-wave receiver. Exact transmitting times are not available, but the station has been heard several times between 8 and 9 a.m., and appears to start at about 7.30 a.m.

WP1A (Suva, Fiji Islands) used to be a very elusive station, and one or two listeners in this country got as far as resolving the carrier-wave on isolated occasions at 7.30 a.m. Reports from U.S.A. indicate that Suva's strength has been increasing steadily,

and it seems that when conditions are right again this station will be easily receivable over here. The call-sign VPD is now in use.

Japanese telephone stations are too numerous to mention. If one hears a terrific carrier-wave and speech in some unknown language or in broken English, the odds seem to be about fifty to one that the call-sign is something between JVA and JVZ!

Central and South Americans are not as strong as they were a few months ago, but still make their presence felt in the 49-metre band. Twenty minutes' listening just after midnight, recently, resulted in identification of fifteen of them, including eight Colombians. MEGACYCLE.

lating the fade-in controls of a battery of microphones, always bringing into circuit the one nearest to the orator.

The accompanying diagram shows how the microphones and speakers have been arranged. On the stage there are seventeen microphone points. Condenser instruments are used throughout, the condenser being placed at the end of a thin arm projecting from the ground; in fact, both arm and tiny condenser are almost invisible at a distance. Each microphone carries a very small lamp which is lighted when it comes into circuit, thus helping the speaker to make the utmost use of the public address system.

ACOUSTICS IN THE OPEN

Nazi Public Address Equipment

By Our Berlin Correspondent

WITH the advent of National Socialism in Germany it has been found that the best way of communicating the new political creed to the masses is by the direct appeal of the massed meeting. And to hold an effective mass meeting demands a suitable meeting place. The "Party" is, therefore, building a number of impressive arenas which go by the name of Thingstätten, or "meeting places of the Elders," the word being drawn from old Teuton sources.

Probably the elders of early times were not called upon to cope with audiences

This drawing clearly illustrates how loud speakers and microphones combine to form an ideal public address system.

the entire system being controlled from a central tower. A new type

of microphone enables the speaker on the platform to forget its presence and thus obtain a clear view of his audience. The speakers or performers are quite unhampered in their movements, the control engineer skilfully manipu-

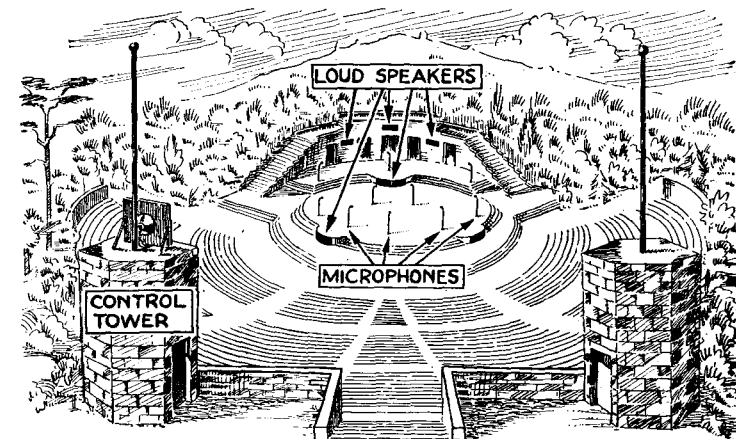

During rehearsals a special microphone is provided for the producer at the far end of the Thingstätte so that he can give intelligible instructions to speakers or performers on the stage. While performances are in progress a special connection is maintained between the control engineer in the tower and the stage manager, and there is also a link between the orchestra and the stage.

In the control room there are eight amplifiers with an output of 20 watts each and one power amplifier of 150 watts. An interesting blocking system automatically prevents the placing in circuit of a microphone which is in front of a working loud speaker, thus eliminating undesirable echo effects.

(Below) The new "Thingstätte" at Heidelberg photographed shortly before a dramatic performance. The microphones are practically invisible. (Left) A close-up of one of the speakers with its weatherproof covering removed.

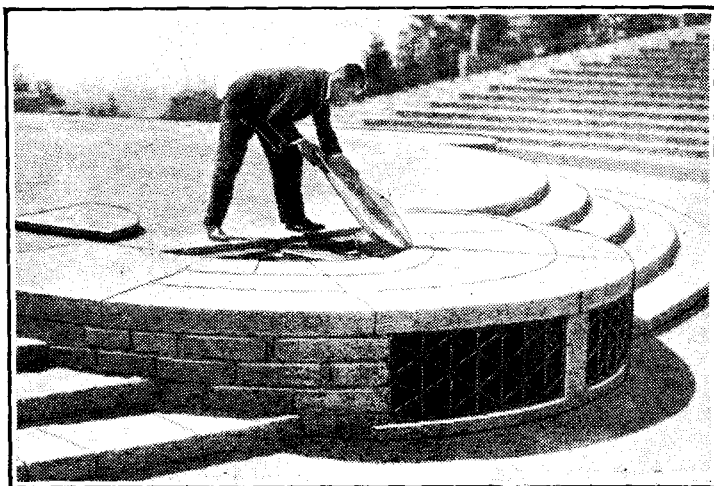

of from 10,000 to 20,000 people, as happens in Germany to-day, but, fortunately for the modern Nazi evangelist, broadcasting technique has provided him with microphones, amplifiers, and loud speakers. It is by their means that the modern German Thingstätten have been made acoustically perfect.

Very little experience in public address work is necessary to discover how difficult it is to distribute sound equally in the open air. Loud speakers must not be too directional nor must they speak back into the microphones. With these points in mind the Telefunken Company has devised an impressive installation at the recently built Heidelberg Thingstätte,

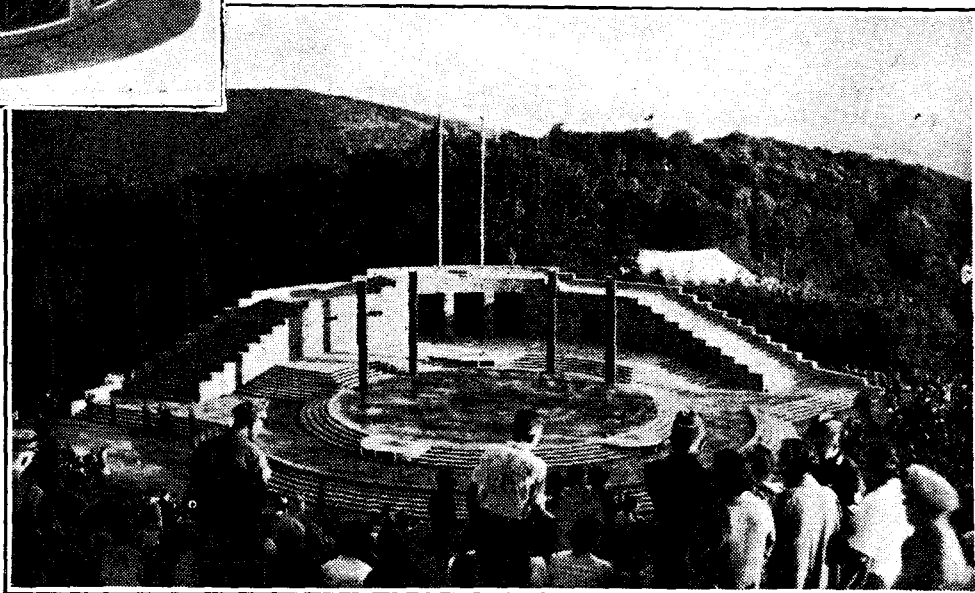

G.E.C. AC MAINS 4

An Efficient "Straight" Receiver with Litz-wound Coils

FEATURES.—*Type.*—Three-stage "straight" receiver for AC Mains. *Circuit.*—Var.-mu HF amplifier—screen-grid detector with reaction—pentode output valve *Full-wave valve rectifier.* **Controls.**—(1) Tuning. (2) Volume and on-off switch. (3) Reaction. (4) Waverange. **Price.**—9 guineas. **Makers.**—The General Electric Co., Ltd.

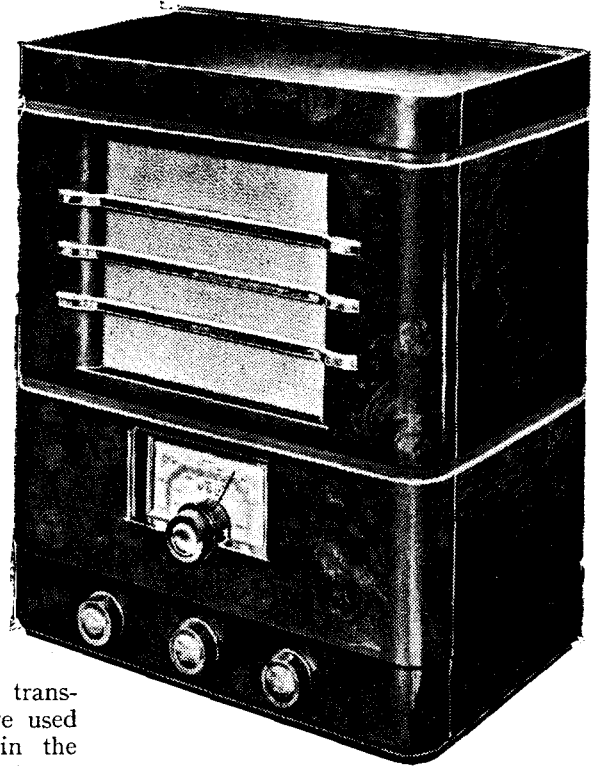

THIS receiver has been introduced to meet the demand for a set of good quality and appearance by those who do not require all the qualities of a superheterodyne or who prefer a well-made "straight" set to a superhet. in which sacrifices have been made in order to bring the price down.

There is certainly no suggestion of skimping anywhere in the chassis or cabinet. Everything is well finished, and the screening of the valves is of an unusually efficient type. The cabinet is moulded and combines strength with good appearance, chromium-plated bars being utilised to relieve the appearance

of the square loud speaker fret.

The circuit consists of an HF amplifier, screen-grid detector, and high-slope pentode output valve, the fourth valve being the full-wave power rectifier. HF transformers with tuned secondaries are used both in the aerial circuit and in the coupling between the HF and detector stages. Low-loss coils wound with stranded wire are used in both cases.

A potentiometer in the aerial circuit provides the volume control and simultaneously increases the negative bias of the variable-mu HF amplifier and increases the damping across the aerial coupling coil. Reaction is applied to the secondary of the HF transformer through a balanced condenser designed to keep the capacity in the anode circuit of the detector valve constant. The reaction condenser is adequately protected from short-circuits by a series fixed condenser.

pentode output valve, and an additional series grid resistance and shunt capacity ensure that stray HF currents do not reach the grid. In addition there is an anti-parasitic resistance between the anode and the output transformer. Terminals are provided for a high-impedance external loud speaker which is fed through a condenser in order to keep the set completely shock-proof. The mains transformer primary is shielded, and interference noises picked up on the mains are kept at a low level.

The tuning scale is neat and is provided with a fine pointer. Immediately below the tuning control is the two-position wave-range switch, the remaining controls to the left and right being the combined volume and on-off switch and the reaction control respectively.

While lacking the property of sustained sensitivity which makes the small superhet. the ideal type for a rapid survey of the evening's home and Continental programmes, the AC Mains 4 is nevertheless capable of a similar performance as

Smooth Reaction

The grid leak of the detector is returned to a point slightly negative with respect to the cathode, and this gives smooth reaction without backlash. When the pick-up is connected the bias is automatically increased to enable the detector valve to work satisfactorily as an amplifier. Resistance-capacity coupling is employed between the detector and the

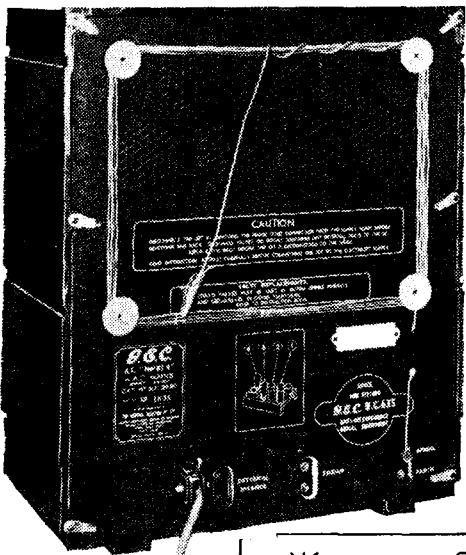

The back panel carries the indoor aerial which should be uncoiled and extended for best results.

Complete circuit diagram. The two tuned circuits are ganged and operated by a single control knob.

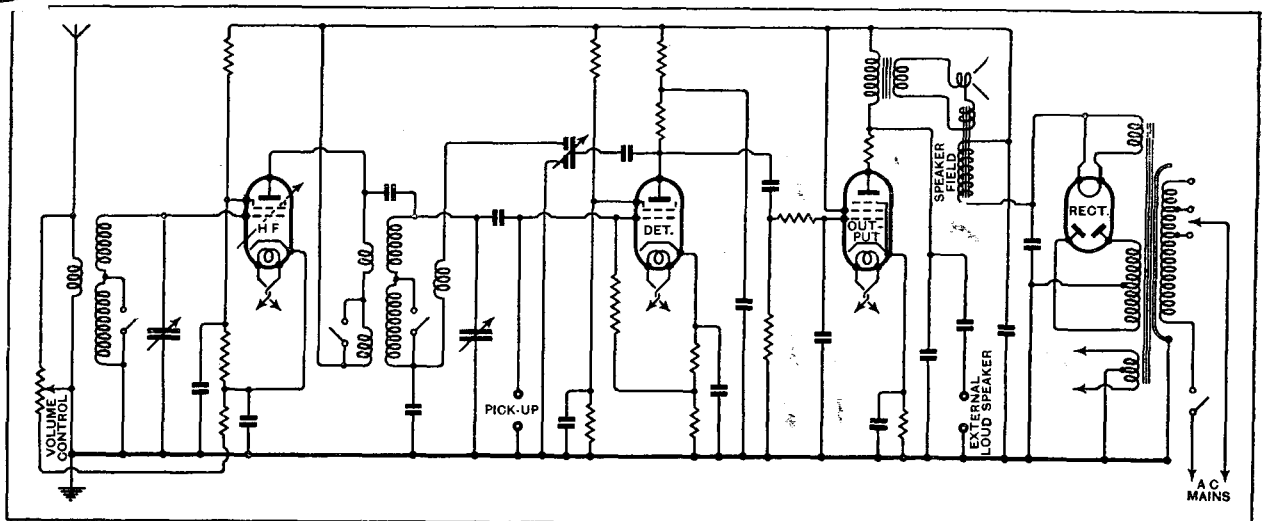

G.E.C. AC Mains 4—

regards range in the hands of those who are prepared to devote a little time to the study of the reaction control. With only two tuned circuits, correct use of reaction is also necessary to obtain the selectivity required for foreign station reception. In this connection the well-known procedure of reducing the input volume control and then restoring the loss with reaction should not be overlooked. Tuned in this way Radio Normandie was received in daylight at excellent volume and just free from interference from London National when using the set on an outdoor aerial in Central London. Several

tector and output stages were fully loaded before the input volume control reached the maximum position. Overloading results in a diminution of volume, and it is always best to start with an obviously low setting of the control and work slowly upwards to ensure that the maximum volume is not passed when loud signals are required.

The reproduction is clear, and the balance of tone shows if anything a bias towards the upper middle register. This is most noticeable on a large aerial when the reaction is of necessity at minimum, but on the indoor aerial the volume and reaction controls can be so worked that

“A Helping Hand”

CO-OPERATION between the technical and business staff of a wireless manufacturing firm is clearly more necessary than in most other spheres of activity. But, so far as the compilation of catalogues is concerned, it often seems that the technician has been denied a chance to have his say, with the result that

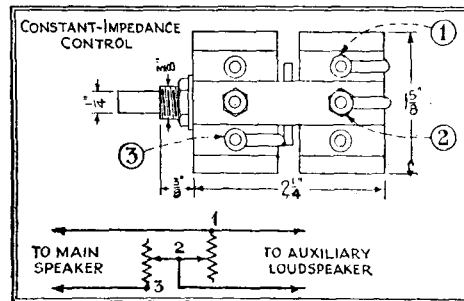

An illustration from the new Claude Lyons catalogue.

the would-be purchaser is left to guess as to what is concealed beneath the neat casing of the piece of apparatus so attractively but so unhelpfully illustrated on the page he is studying.

But the title chosen for the new Claude Lyons catalogue, “A Helping Hand to Set Constructors,” means what it says. In many cases physical dimensions are shown in outline sketches, and, in addition, there are skeleton circuit diagrams to illustrate the appropriate connections. The publication deals very largely with resistances (fixed and variable) and potentiometers of all ratings and of various types. Again, switches constitute an important side of the firm’s activities, and a good deal of space is devoted to other products, such as power transformers, microphones, condensers, etc.

Claude Lyons, Ltd., of 76, Oldhall Street, Liverpool, 3, tell us that they will be pleased to send copies free and post free to readers mentioning *The Wireless World*.

THE RADIO INDUSTRY

A NUMBER of McMichael portable receivers were installed in caravans taking part in the recent Caravan Rally at Withdean Park, Brighton. Incidentally, individual leaflets dealing with each of the new season’s McMichael sets are now available, as well as a folder describing the whole range.

In addition to the Dubilier catalogue mentioned last week, another publication, “Radio Engineering Catalogue Number 835,” has now been issued. This is specially intended for designers, technicians, manufacturers, and service engineers, and is rather more comprehensive in its scope.

The recent series of *Wireless World* articles dealing with the manufacture of permanent magnets have now been reprinted in booklet form by the Permanent Magnet Association, Williams Deacon’s Bank Chambers, Church Street, Sheffield. The Association will be glad to send copies to anyone interested.

The repair department of London Transformer Products, Limited, Cobbold Estate, London, N.W.10, has now been enlarged, and in addition to the rewinding of transformers, etc., repairs to motors and generators can be undertaken.

The new Watmel list deals with fixed resistances, potentiometers, heavy-duty rheostats, etc. Address Watmel Wireless Company, Ltd., Imperial Works, High Street, Gwage.

Change of address: Correx Amplifiers, to Peckford Place, Brixton, London, S.W.9. Telephone: Brixton 3782.

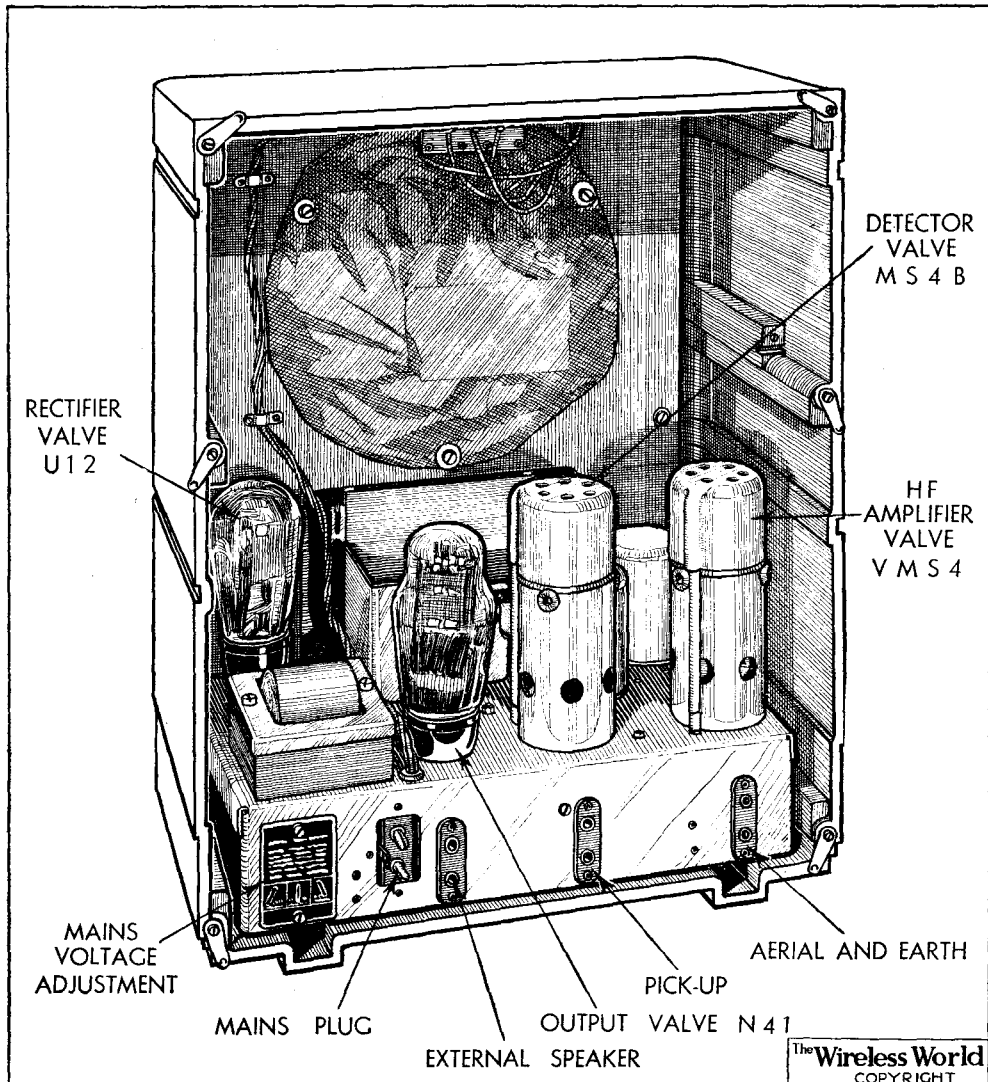

View with back panel removed. Note the efficient screening of HF and detector stages.

other medium-wave foreigners were also received, but reaction had to be worked so close to the oscillation point that slight readjustment of the volume control caused the set to break into oscillation. After dark these and other stations would be received with the reaction sufficiently far from the critical point for this slight interdependence of the controls to pass unnoticed.

On the Indoor Aerial

No reaction at all was required for the local stations or Droitwich, and even on the short indoor aerial provided the de-

the bass reproduction is pulled up to the level of the top. The station must, of course, be accurately tuned.

The internal aerial can be neatly coiled up on the back panel of the set. This panel cannot be removed without first withdrawing the mains plug. Holes are drilled and a space provided for fitting an anti-interference aerial transformer in cases where local interference from electrical machinery is troublesome.

Next Set Review—
MURPHY A28C

The Wireless World
COPYRIGHT

Listeners' Guide

Outstanding Broadcasts at Hand

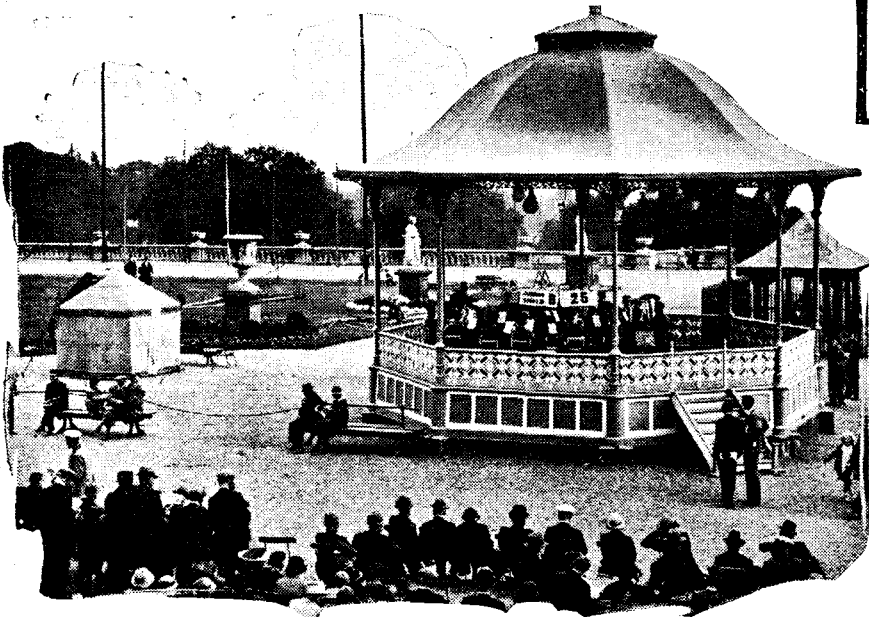

THE ACID TEST. On Sunday the winners of this year's national band contest at the Crystal Palace give a concert in the Regional studio. The photograph shows a contest in progress, the judges' tent being on the left.

musical programmes in point of popularity.

Among the most noteworthy speakers of the week will be Dr. W. R. Inge, who comes to the National microphone at 10.10 on Tuesday to introduce a series on "The Dangers of Being Human," described as "a psycho-analytical approach to social problems."

M. Stéphan's French courses open on Tuesday, and a first-year course in Spanish by Senorita Maria de Laguna on Thursday.

Short stories are becoming more popular at the microphone. They are to be given at an earlier hour on Sundays in the National programme, viz., 6.45, and the story at that time on Sunday next will be "The Episode of the French Chocolates," by Gweneth Morgan.

The majority of the new talks series begin towards the end of the week.

GEORGE GRAVES IN "VÉRONIQUE"

THE ever-young George Graves will take his original part of M. Coquenard in Messenger's charming light operetta "Véronique," to be broadcast Nationally at 8 on Thursday next. The play was first produced in 1904, and

THE BEST BAND

THE Crystal Palace is the Bayreuth of the band lover at this time of the year. From far and near come the brass bands of the Nation for the annual festival at Sydenham, and the pity is that, out of so many shining groups setting out full of puff and hope for London Town, only one band can win the contest.

The champions of to-morrow's event are coming to the Regional studio on Sunday afternoon, at 5.30, to broadcast a number of the pieces with which they secured the coveted trophy. The items include the march from "Tannhauser" and the suite, "Pride of Race," by Kenneth A. Wright.

SHELSLEY WALSH TO-MORROW

PEOPLE who listen to very few running commentaries make a point of tuning in the International Open Hill Climbs at Shelsley Walsh. For to-morrow's broadcast (Reg., 4.30), thanks to the courtesy of the Midland Automobile Club, a new arrangement has been made under which all the fast cars and crack drivers will be grouped together for the time of the relay. This, it is hoped, will prevent listeners missing, as they have sometimes done owing to breakdowns on the hill, some of the star climbs of the meeting.

The length of this Worcestershire course is 1,000 yards and the average gradient 1 in 8.907.

To-morrow's commentary will be given by Mr. F. J. Findon and Major Vernon Brook.

COMPOSER-PIANIST

NOT many operatic composers rank as pianists, but Arthur Benjamin, whose jolly opera, "The Devil Take Her," was relayed from Sadler's Wells a season ago, is a pianist of distinction, notably as an interpreter of Chopin, whose works figure in his broadcast recital in the Regional programme at 9.25 on Monday next, September 30th.

NAPOLEON AT THE MICROPHONE

IT is surprising that Napoleon has not figured more in the B.B.C.'s historical broadcasts. The omission will be remedied in downright style next week when a play, "Brumaire," by Anthony Ellis, will be broadcast on Monday (Nat., 8.55) and Wednesday (Reg. 8).

The play deals with Napoleon's *coup d'état* of November, 1799, when the future Emperor, not without the help of his brother, Lucien, overthrew the Directory and by the "Constitution of the Year VIII" made himself First Consul for a period of ten years.

The part of Napoleon will be played by the author and production will be in the hands of Mr. Robin Whitworth. The action of the play follows Napoleon from one Council Chamber to another. It shows how, but for the intervention of Lucien Buonaparte, he might have wrecked the whole scheme by his lack of discretion in the Council of the Elders at St. Cloud.

HILL-BILLY NIGHT

THE "Rocky Mountaineers" already have a large following among listeners. In presenting

his troupe down from the Canadian Lumberjacks' Bunkhouse on the mountain slopes to take part with the homesteaders from the foothills in a barn dance in real hill-billy style. An attempt will be made to create the genuine atmosphere of one of these Canadian gatherings, in which reels and other square dances are entered into with great zest.

The "caller" will be heard above the joyous noise describing the figures of the dances.

TALKS SEASON

NEXT week sees the opening of the winter talks season, and to judge from the syllabus there is a distinct possibility that the spoken word may seriously challenge the



"BRUMAIRE." Bouchot's picture in the Louvre, Paris, which portrays Napoleon Buonaparte in the Council of the 500 at St. Cloud on November 10th, 1799. Anthony Ellis's broadcast play, "Brumaire," deals with the events associated with the *coup d'état*.

Guide for the Week

Home and Abroad

Thursday's broadcast will be a slightly condensed version of the original libretto, specially prepared for the microphone by Gordon McConnel. The early scenes of the show, which is set in Paris in 1840, take place in the fashionable flower shop of Monsieur and Madame Coquenard. The part of the flighty wife will, on this occasion, be taken by Janet Lind, and the heiress-heroine, who masquerades as the shop girl, Véronique, will be played by Betty Huntley-Wright.

The fact that the plot of the play is highly complicated may not assist the broadcast, but

opera, "Neron y Acte," by Juan Manén, to be given by Stuttgart and Frankfurt from midnight to 2 a.m. This will be a complete disc recording of a previous performance of the opera in the Stuttgart studio.

Saturday's principal operatic broadcast is Delibes' unfamiliar "Jean de Nivelles," which Radio-Paris is broadcasting at 8.45. The same evening Rome is broadcasting two one-act operas by Guisepppe Mulè. These are "Al lupo" and "La Monacella della fontana" (The Young Nun at the Fountain).



HAYDN'S STRING QUARTETS are to be played throughout next week in the Foundations of Music series by the Kutcher String Quartet. (Left to right): Samuel Kutcher, leader; Frederic Grinke, second violin; Douglas Cameron, 'cello; and Raymond Jeremy, viola.

Messenger's delightful melodies, coupled with the sleight of hand of Gordon McConnel, should make for a really satisfying production.

"ROSE-MARIE"

"ROSE - MARIE," Friml's ever-popular operetta, is in the Brussels No. 1 programme from 8 to 10 p.m. next Thursday.

OPERAS

THE Bellini centenary is still being observed on the Continent, and perhaps the most important opera transmission of the week is the repetition this evening (Friday) at 7.30 of "I Puritani" from Vienna. Budapest and Hilversum are both relaying this broadcast.

To-night brings us something new from Munich, viz., Paul Graener's opera, "Der Prinz von Homburg," at 8.15.

Another novelty to-night will be a complete modern Spanish

Berlin is giving a "trailer," to use film parlance, entitled "Broadcast Opera," at 8 p.m. on Sunday, consisting of selections from various operas to be broadcast during the season.

RECITALS

THE coming week is rich in recitals and classical concerts. Sunday brings a zither recital from Leipzig at 3, a classical violin recital from Warsaw at 4, and Bach, Debussy piano-forte music from Brussels No. 1 at 6, and a Saint-Saëns septet (on records) from the same station at 7.15. Monday's list opens with a Bach organ recital at 6 from Warsaw, followed by a 'cello and piano-forte recital at 8. From Brussels No. 2 at 9.15 comes a half-hour performance of his own pianoforte works by Walter Niemann. Tuesday's most promising item is a violin recital by Florizel von Reuter from Konigsberg at 9.

HIGHLIGHTS OF THE WEEK

FRIDAY, SEPTEMBER 27th.
Nat., 8, Beethoven Promenade Concert. 10.10, Night Falls in Budapest, 3rd episode. 11.15, Harry Roy and his Band. Reg., 8.20, Radio Play: "The Use of Man" by Lord Dunsany. 9, Harold Ramsay and his Band.

Abroad.
Radio-Paris, 8.45, Concert of works by Ex-Servicemen.

SATURDAY, SEPTEMBER 28th.
Nat., 8.40, "Music Hall." "Night Falls in Budapest, 4th episode." "B.B.C. Dance Orchestra." Reg., 8, Promenade Concert. "Part Songs by the B.B.C. Men's Chorus."

Abroad.
Motala, 8.30, Orchestral Concert. Soloist; Joseph Hislop (tenor).

SUNDAY, SEPTEMBER 29th.
Nat., The Serge Krish Septet. "Pierrot in Music"—Leslie Bridgewater Quintet. "Leslie Jeffries and Orchestra, Grand Hotel, Eastbourne."

Reg., London Palladium Orchestra. 5.30, Winners of National Brass Band Contest. "B.B.C. Orchestra conducted by John Barbirolli."

Abroad.
Leipzig, 8, "Opera Music, Old and New," by the Leipzig Symphony Orchestra, with soloists.

MONDAY, SEPTEMBER 30th.
Nat., The Air-do-Wells. 8.55, "Brumaire"—a radio play. "The Nelson Trio." "Maurice Winnick and his orchestra."

Reg., 8, Wagner Promenade Concert. "Chopin Recital by Arthur Benjamin."

Abroad.
Athlone, 8.30, Modern English composers (Elgar, Quilter, Besly).

TUESDAY, OCTOBER 1st.
Nat., "The Red Sarafan"—evening of Russian Cabaret. 8.45, Old Time Ballad Concert with B.B.C. Theatre Orchestra.

Reg., The Air-do-Wells. 8, Promenade Concert. "One Piano: Four Hands—Recital by Alec Rowley and Edgar Moy."

Abroad.
Warsaw, 9.15, Bach Concert from the Conservatoire.

WEDNESDAY, OCTOBER 2nd.
Nat., 8, Brahms Promenade Concert. "Viennese Operatic programme by B.B.C. Orchestra."

Reg., 8, "Brumaire." "Variety of Music"—compèred by Bryan Michie.

Abroad.
Stuttgart, 9.45, Selections from "The Geisha."

THURSDAY, OCTOBER 3rd.
Nat., 8, George Graves in "Véronique" (Messenger). "B.B.C. Military Band." "Gershon Parkington Quintet."

Reg., 7, "Tunes of the Town," compèred by John Watt. 8, Mozart-Haydn Promenade Concert. "Programme of Gramophone Records."

Abroad.
Brussels No. 1, 8, "Rose-Marie"—a musical play.



GEORGE GRAVES, who takes his original part of M. Coquenard in next week's broadcast of "Véronique." He is seen above in another favourite musical comedy, "Florodora."

INFLUENCE OF JAZZ

"JAZZ and its Influence on Symphony Music" is the title of an unusually interesting concert to be broadcast by all the French PTT stations from 8.30 to 10.30 on Tuesday next. Selections will be given from the most notable symphonic works of recent years which are distinctly influenced by jazz rhythm. Notable among these are Stravinsky's "L'Histoire du Soldat," and Inghelbrecht's "Métamorphose d'Ève."

ACOUSTICAL TESTS

IF language is no barrier many listeners should find interest in "45 Seconds Reverberation Time"—a Munich transmission at 10.20 on Monday, featuring recordings of acoustical experiments at the Heinrich Hertz Institute.

GERMANY AND THE "PROMS"

GERMANY pays the B.B.C. a pretty compliment next week, not only by relaying the Queen's Hall Promenade Concert on Tuesday via Leipzig, Deutschlandsender and Stuttgart, but by transmitting a recorded version of the same concert from Munich on Thursday between 11 and midnight. It should be an interesting experience to compare the two transmissions. The concert includes the Schubert-Liszt arrangement of the "Wanderer Fantasia" for pianoforte and orchestra, with Lamond as soloist. THE AUDITOR.

New Apparatus Reviewed

M.R. MICROPHONE

M. R. SUPPLIES, 11, New Oxford Street, London, W.1, have introduced a hand-type version of their transverse current carbon microphone for use where a portable instrument is required. The microphone is the same pattern that they supply in table and floor stands for public address work, it being suspended in a frame in the same manner, but in this model the frame is fitted with a short handle. Frame and microphone are finished in chromium, and the whole presents a very pleasing appearance.

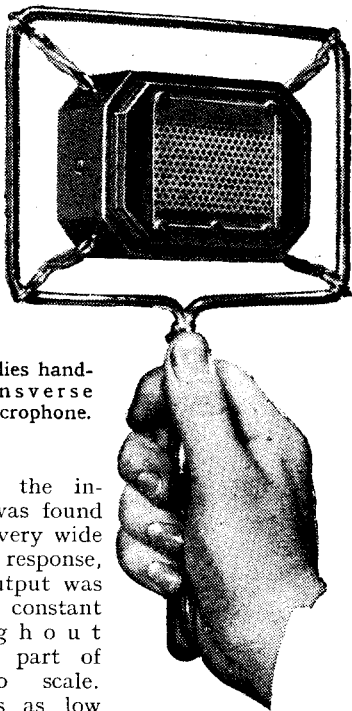

M. R. Supplies hand-type transverse current microphone.

On test the instrument was found to have a very wide frequency response, and the output was practically constant throughout the major part of the audio scale. Frequencies as low as 25 c/s were reproduced, and the upper limit was well above 10,000 c/s.

It has an impedance of approximately 500 ohms, and so requires a transformer with a 10 to 1 ratio, assuming that an input volume control of 50,000 ohms be joined in the grid circuit of the first valve in the amplifier.

A three-stage resistance-coupled amplifier, or its equivalent in gain, will be required for public address work. The noise level of the microphone is exceptionally low, largely, no doubt, because it operates satisfactorily with a small polarising voltage, between 6 and 12 volts being all that is needed.

The price complete is £2 7s. 6d.

B.T.S. ULTRA-SHORT WAVE CONDENSERS

AMONG the new season's B.T.S. products is a range of condensers designed especially for ultra-short-wave use. There are two variable models rated at 67 and 160 m-mfds. respectively, a series of fixed air-spaced padding condensers, which are available in sizes up to 200 m-mfds., and a small trimming condenser, also air-spaced, which can be supplied in capacities up to 40 m-mfds. All have silver-plated vanes.

Recent Products of the Manufacturers

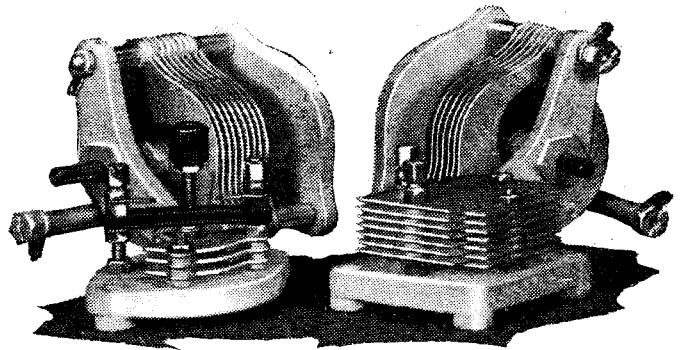

Selection of B.T.S. ultra-short-wave condensers, including variable and fixed capacity types.

In all these new components the minimum of insulating material is employed, yet these condensers are robust and will stand up to normal stresses without distorting.

The variable condensers each has a measured minimum capacity of 6 m-mfds., and their maximum value is 64 and 175 m-mfds. respectively. The smaller model costs 7s. 6d. and the larger 8s. 6d.

The air-spaced padding condensers have many uses in short as well as in ultra-short-wave sets, especially as their capacities can be so easily adjusted by removing plates. These occupy relatively little baseboard space, and even the larger sizes are quite compact, as very close spacing of the vanes is adopted. They cost 3s. 3d. each.

The miniature trimming condenser tested has two moving and three fixed vanes. Like all the other B.T.S. components in this series it is mounted on Megacite, which is a white insulating material with especially good dielectric properties at the very high radio frequencies. The minimum capacity of this size trimmer is 2.5 m-mfds. only, while its maximum value is 14.3 m-mfds. It costs 2s. 9d., and the makers are British Television Supplies, Ltd., Eush House, London, W.C.2.

BULGIN IF TRANSFORMER TYPE C50

THIS new intermediate frequency transformer, made by A. F. Bulgin & Co., Ltd., Abbey Road, Barking, Essex, is designed for use in IF amplifiers of 450 to 465 kc/s. It is a very compact unit, for it measures 2in. in diameter only, and is 3½in. high. The trimmers are mounted at the top, and all connections are taken to long soldering tags arranged in a circle on a baseplate of bakelite. This supports the whole assembly, and the cover can be removed, if necessary, with-

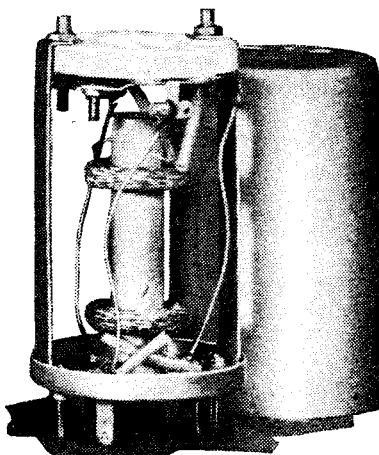

Bulgin 450/465 kc/s IF transformer.

out disturbing the wiring by unscrewing two nuts.

The coils are wound with stranded Litz

wire on a wooden former, the spacing being arranged to give the correct coupling for the band width allowed, which in this case is stated to be approximately 10 kc/s.

In a test circuit fitted with a valve of average efficiency a stage amplification of 200 was obtained. Considering that the band width is adjusted to ensure the retention of the higher speech frequencies, the

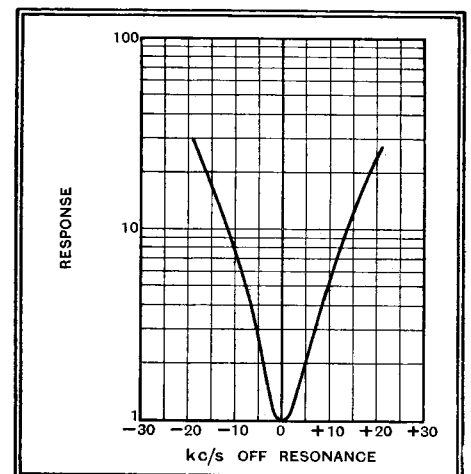

Response curve of Bulgin IF transformer adjusted to 465 kc/s.

adjacent channel selectivity is very good; moreover, it is adequate for all normal requirements. This transformer costs 8s.

A Useful Catalogue.

ONE of the minor difficulties of the serious amateur who works along original lines, and does not merely follow the fashionable circuit of the moment, is to find sources of supply for the components and accessories he needs. This applies to small parts and materials even more than to large and costly accessories; too many manufacturers and suppliers seem to have a soul above such insignificant things as wire, screened sleeving, small insulators and connectors, and wiring accessories.

To the amateur of the kind we have in mind, the latest Goltone catalogue is almost a source of inspiration as well as a source of information. It deals not only with the more-or-less standardised components that are to be found in many other lists, but also with many electrical accessories and fittings with which unconventional circuit arrangements may often be carried out. Anti-interference gear includes chokes and units constructed to G.P.O. specification, while a number of air-cored inductances of values suitable for inclusion in tone-correctors and similar devices are shown. Copies of the catalogue are obtainable from Ward and Goldstone, Ltd., Pendleton, Manchester, 6.

The Radio Shows Compared

Sidelights on French Broadcasting

By a Special Correspondent

THE Paris Radio Salon had a dignity shared neither by Olympia nor Berlin, being housed in a building of distinguished architecture—the Grand Palais on the Champs Elysées. Add to this the French artistry which converted the interior into a symphony of softly blended colour and the points of superiority come to an end.

I was chiefly impressed by the extent to which the Salon had been influenced by Olympia. Television had been omitted for much the same reasons, and I found in the Grand Palais a strong disinclination to discuss the matter above a whisper. All the indications are that high definition television will be much slower off the mark than in either London or Berlin. Yet Paris is the envy of both the other capitals in having the ready-made Eiffel Tower, 980 feet high and centrally situated, for its station. I was informed at the Ministry of Posts and Telegraphs that the Eiffel Tower will soon be used for a 180-line transmission of 7 metres. October was mentioned as the month in which transmissions would start, but I am certain that this is optimistic. The television studio and equipment in the Ministry buildings are, to British eyes, improvised. Experimental sixty-line broadcasts have been sent out from here for some time twice a week, and I understand that the same studio will be used for high definition.

“Stabilised Technique”

The resemblance to Olympia was heightened by the fact that so many of the same names decorated the stands. Unlike Olympia or Berlin, the French show is international, so that, quite apart from the French branches of international firms, British, American and German companies may exhibit.

Perhaps it is only natural that the shows produced by the two great democracies of Europe should have more in common with each other than with the exhibition produced by a Fascist régime. The similarity, of course, extended to technique, but not to prices, which seemed to be considerably higher, perhaps as much as 50 per cent. I understand, however, that nearly everybody in France obtains his set at less than the advertised price.

“Stabilised technique” was the slogan adopted by the organisers.

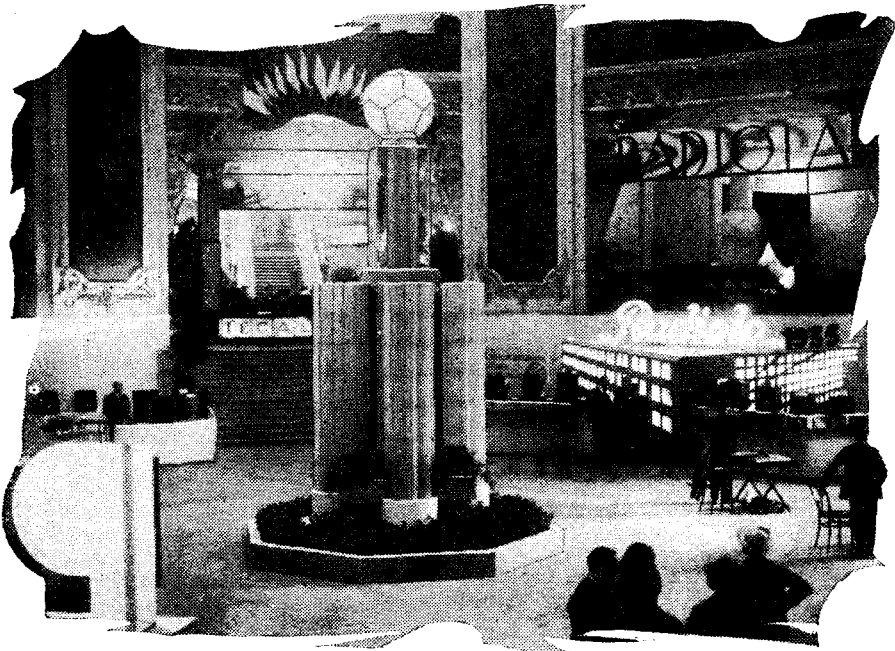

The main entrance hall at the Paris Radio Salon

Though the total number of wireless set owners in France was on August 1 only 2,099,777, La Société pour la Diffusion des Sciences et des Arts is well satisfied with the progress of the exhibition itself. A dozen years ago it was only a small annexe of the Motor Salon. In 1932 the stands covered an area of 2,300 square metres and there were 155 exhibitors. Steady expansion has taken place year by year until this year the State exhibited for the first time and the total area was 4,800 square metres, with 225 exhibitors.

In France there are eleven private and fourteen State-owned stations. The general impression is that the State is unlikely to extend its jurisdiction to more of the private stations and that the two sections will continue to exist side by side, giving to French radio and, incidentally, to the Radio Salon, a unique character.

Behind the Scenes

M. Mandel, the French Minister of Posts and Telegraphs, is the French equivalent of Mr. Hore-Belisha in the matter of enterprise, and it was no doubt due to his initiative that the Government took the whole of the extensive Salon d'Honneur. I was interested to note that here the same idea was at work as in Berlin, but on a smaller, less highly organised scale. It was an attempt to show the public the inner workings of broadcasting. There were a stage on which radio artists and orchestras performed, a glass-panelled control room where visitors could see the works, the huge diagrams and illustrations on the walls showing the remaining stages of the broadcast, and

the land-line distribution throughout France. Incidentally, I noticed that the French are now copying the B.B.C., calling the long-wave Radio Paris transmitter the National and the provincial transmitters Regional stations.

Announcers in Wax

The private stations, which occupied rather less space in an entirely separate section, modelled their display on more popular lines. Poste Parisien provided the chief features—a series of waxwork tableaux showing radio announcers, artists and executive chiefs at the microphone or at their desks. I can vouch for the fact that these models were life-like, for I had the uncanny experience of seeing several of the originals walking about in the exhibition.

I did not have time to inspect the studios of all the Paris broadcasting stations, but I understand that those of Poste Parisien are the best equipped. Indeed, my general impression is that French State broadcasting is not yet fully fledged and in the next few years may be expected to make great strides. The new 120 kilowatt transmitter built at Palliseau-Villebon for Paris P.T.T. is a first step. Here also will be the new Poste Coloniale station which will use 50 kilowatts at first, and, according to official spokesmen, is destined to go still higher. What I think will give State broadcasting a new lease is the proposal to concentrate all the Paris studios and offices, at present distributed round the city, in a Broadcasting House built as the main feature of the International Exhibition of 1937.

The Radio Shows Compared—

In view of the economic difficulties of the radio industry in France the price of stand rents had been lowered for this exhibition. Like both the other exhibitions, it suffered from the inability to demonstrate receivers by wireless link, and, as at the others, music was relayed to the

standholders from a central distributing station. But an interesting departure from the practice at London and Berlin was that foreign programmes were actually included in the relays. I heard the exquisite tones of a B.B.C. announcer echoing through the halls on one occasion and music from Droitwich.

though the HT current is some 40 milliamperes I don't find that it costs me a great deal to work. I have, though, come across people who were trying to run superhets drawing some 20 milliamperes of current from small dry cell HTB's, and naturally they complained rather bitterly about running costs.

Random Radiations

The Command Variety Performance

IT seems unlikely that the Royal Command Variety performance will be broadcast on October 29th. The whole trouble is one of pounds, shillings and pence. Last year the B.B.C. paid the Variety Artists' Benevolent Fund 500 guineas, but so great were the attractions of the broadcast that vast numbers of listeners stayed at home to hear it on their wireless sets instead of visiting theatres and music halls as otherwise they would have done. The net result was that box office receipts were down on that one night to the tune of something like £100,000. Not unnaturally, then, the Variety artists have said that they will not permit a broadcast this year unless the B.B.C.'s contribution is far larger.

The B.B.C. finds itself on the horns of a dilemma; on the one hand, this is the *Jubilee* Command Performance and it will undoubtedly be one of the finest shows of its kind ever staged; on the other, it could not possibly justify the expenditure of many thousands of pounds upon a single broadcast programme. Though listeners will naturally be disappointed if the performance is not relayed, none but the unreasonable will fail to understand the position.

And the Final Cup Tie

Another broadcast that we are likely to lose is the running commentary on the Final Cup Tie at the end of the present football season. Here the position is altogether different. Every available seat is invariably sold weeks before the date of the match, and on the day itself thousands who hope to find standing room are always turned away from the gates. There is, therefore, no possibility of the broadcasts causing any reduction in the gate money. But the football authorities are not satisfied with the fee that the B.B.C. offers and have more or less decided that the relaying of a commentary is not to be permitted. The position seems more hopeful than in the case of the Command Variety Performance. There are thousands of listeners to whom the relay has in the past been one of the greatest events of the year in wireless, and owing to the huge demand for the broadcast the B.B.C. would have wide support for making a very substantial payment. I imagine that the way is still open for negotiations and that a compromise can be reached if both sides will "show willing." After all, the Football Association must realise that a broadcast of this kind is greatly to its advantage owing to the way in which it maintains and fosters interest in soccer.

Battery Superhets

THIS year there are not very many battery superhets, the reasons for their small numbers being, (1) the difficulty of

By "DIALLIST"

designing efficient sets of this class with a small high tension current drain, and (2) the fact that the general public refuses to use dry cell HTB's of greater capacity than the "standard" size. The utmost load that can be placed upon a good quality battery of this size is certainly not more than 10 milliamperes, and I should myself put it at much nearer 5. To make a battery superhet whose total high tension current requirements are in the neighbourhood of 10 milliamperes is something of a feat, but it has been done. Those of this year's crop of battery superhets that I have tried have been, on the whole, very good little sets, though I can't help wishing that the public had given their designers rather more latitude in the matter of high tension current, as it could have done had it realised the great advantages, pecuniary and otherwise, of using HTB's of reasonably large capacity. If only you will use a HTB that is well up to the work it is surprising how small are the running costs of even a large battery superhet. I have one in use at present of my own design which employs no fewer than eight valves, the output stage being of the true push-pull type. It is run from a high tension accumulator, and

A Battery Suggestion

As it comes from the makers a battery superhet may have room within its cabinet for nothing larger than a standard capacity HTB. If this is so it is a very good tip to have either a plinth or a pedestal stand made for the cabinet big enough to contain a dry cell battery of large capacity or a high tension accumulator battery. The battery leads will probably require to be lengthened, but this is a job which presents little difficulty to the handyman. The advantages of using a high tension battery that really is up to the work are enormous. In the first place you don't suffer from day-by-day (or even hour-by-hour) deterioration in reproduction; in the second, though the initial cost of the battery is higher, you save a great deal of money in renewals or recharging in the course of the year's working.

Poor Chelmsford

PASSING through Chelmsford the other day I couldn't help casting a sentimental eye on the masts of the old Marconi long-wave station which was the original 5XX. It was from the aerial suspended between them that Dame Nellie Melba's momentous broadcast was transmitted in 1920. She was the first great artist to appear before the microphone, and by doing so she made the future of broadcasting secure. She stood almost alone in her profession in not offering violent opposition to broadcasting; but once she had led the way that opposition, which might almost have stifled broadcasting at birth, rapidly broke down.

The 450 feet aerial masts at Chelmsford are now being demolished. Thirty men are engaged on the job, and they will need five months to carry it through. The Chelmsford station was a good friend in the past to wireless enthusiasts, and old hands will regret that it has now seen its day.

Ships Without Wireless

AT the moment of writing nothing has been heard of the motor ship *Joseph Medill*, which sailed from the Tyne for Canada on August 10th. The Board of Trade regulations require all cargo ships of more than 1,600 tons gross to carry wireless equipment. The *Joseph Medill*, of 2,086 tons register, obtained exemption because she was built for service on the inland waterways of Canada, where wireless is not necessary. It hardly seems right that a ship of a novel kind—the *Joseph Medill* is electrically welded throughout and contains no rivets—should be allowed to make her maiden voyage without, at any rate, temporary wireless gear, particularly as she was constructed for lake and canal service and not as an ocean-going vessel. Had she carried temporary equipment she could have kept in touch with other ships, and there would have been no cause for the present anxiety about her. In future no such exemptions should be permitted under any pretext. Wireless equipment is an essential safeguard to-day for seafarers.

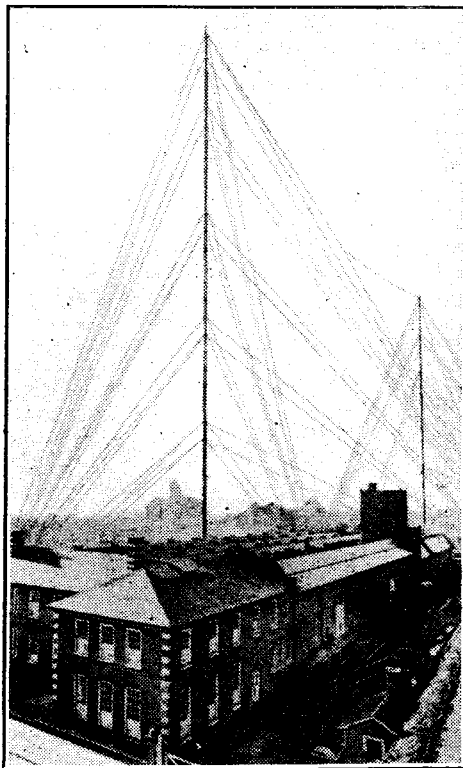

OF PASSING INTEREST. The masts of the old Marconi long-wave station at Chelmsford are being dismantled.

BROADCAST

By Our Special Correspondent

BREVITIES

B.B.C. and Abyssinia

THE B.B.C. gets dragged into everything. What is the Corporation doing about Abyssinia? is the latest question, and one might imagine from the gravity with which it is put that the B.B.C., with its usual omnipotence, could really change the fate of nations.

Nevertheless, the question is an interesting one because, in the event of hostilities breaking out between Italy and Abyssinia, British listeners will look to broadcasting to give them something in the nature of eyewitness accounts, if not actual running commentaries.

Strict Neutrality

Actual commentaries are expected by American listeners, and the National Broadcasting Company is undoubtedly losing no chance of establishing a link between the field of possible hostilities and the American broadcast network. At the moment the B.B.C. is observing strict neutrality, and I understand that the Governors are awaiting Foreign Office instructions. If permission were given for relays from Abyssinia or its frontiers, plans which have already been prepared would be immediately translated into action.

Egyptian Test

The B.B.C. relay from Cairo on October 6th, in co-operation with the Egyptian State Broadcasting Service, will afford an excellent rehearsal for possible liaison broadcasts of the future.

Future of Dr. Boult

ADRIAN BOULT is a name to conjure with, a name to adorn concert programmes and illuminate those fascinating boards which deck the Queen's Hall. It should not, however, appear on music stool requisition forms and receipts for cartloads of violin resin and drumsticks, tympani, for the use of . . .

Red Tape

Quite rightly Dr. Boult is trying to free himself from the strangling effects of B.B.C. red tape. He came to the Corporation as a conductor of established reputation, for the purpose of conducting concerts, and not to act as departmental manager or musical Pooh Bah.

To be Assistant Controller?

Not all forecasts give me so much happiness as that which I now make, viz., that in the near future Dr. Boult will be given an assistant controller-

ship. This will relieve him of office drudgery and permit a wider exercise of those talents which have put him in the front rank of European conductors of to-day.

The Winter Symphony Concerts

Dr. Boult, by the way, will conduct seven of the twelve B.B.C. Symphony Concerts which are to be broadcast from the Queen's Hall on Wednes-

day. For some years now the man who has had to bear the brunt of these postal deluges has been Mr. Roland Wynn, who, to my personal knowledge, has always faced the ordeal with great fortitude. Now, as a reward,

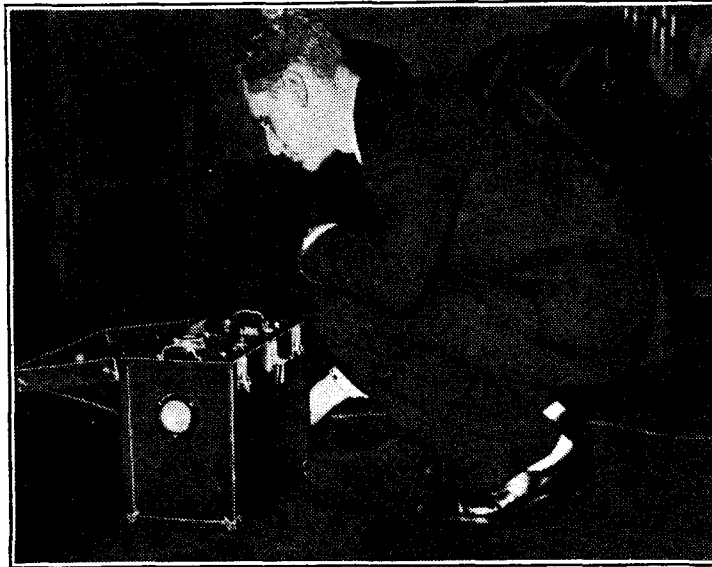

THE DECIBEL TEST. The future career of aspiring broadcasters in the U.S. National Broadcasting Company's amateur hours on Wednesday evenings is decided by this "applause machine"—an audiometer which measures the volume of applause for each item.

day evenings between October 23rd and March 25th next. For the remaining five the conductors will be Sir Henry J. Wood (two), Sir Hamilton Harty (two), and M. Ernest Ansermet (one). The programmes cover a wide range of classics as well as the works of modern composers. Beethoven's Third, Fifth, Seventh and Ninth Symphonies, Brahms' and Schumann's First Symphonies are included, together with works by Handel, Mozart, Schubert and Berlioz.

Modern Masters

The B.B.C. has dipped deeply into the bag of contemporary composers, for the list includes Elgar, Bela Bartok, Alban Berg, Arthur Bliss, Hindemith, Constant Lambert, William Walton, Schönberg and Stravinsky.

A Well-earned Promotion

TO relieve the grimness of this page I am sometimes able to procure an extract from the

he is translated to a higher sphere, having been appointed Senior Superintendent Engineer.

For the sake of readers for whom B.B.C. titles only add mystery, I may mention that this places Mr. Wynn next to Mr. H. Bishop, Assistant Chief Engineer.

Microphonised Café

THE Mystery of the Seven Cafés" has proved the café to be an excellent *mise-en-scene* for bright broadcasts. As forecast in the Variety Director's autumn arrangements, the microphonised café is to be translated this winter to a beauty spot in Italy ("Across the Bay to the Villa San Marina"). Here, under an Italian sky, a lovely café has been discovered in which there is good food, good music and good humour. The well-known broadcasting orchestra of Mantovani has been persuaded to visit these lovely surroundings once a month and broad-

cast to British listeners, the first occasion being October 24th.

Temperamental Interludes

The local guide of San Marina will be there to take visitors around, and there is also at the Villa San Marina, it appears, a very stout and garrulous patron keen on directing the orchestra but suffering from a temperament because he does not like music. Perhaps we may expect some interruptions.

Berlin to Broadcast B.B.C. Drama

FOR the first time in German broadcasting history an English microphone play is to be broadcast from Berlin on October 8th. This is "Friday Morning," an original radio drama of Val Gielgud's, which was first broadcast by the B.B.C. some two years ago.

German Initiative

This thriller is quite cosmopolitan in scope, for it deals with the reactions of the passengers and crew of a London-Paris plane before a forced landing. I hear that the original broadcast was picked up by Intendent Bermelberg, of the Berlin station, who earmarked it for translation. A wideawake people, the Germans.

Lost Opportunities

How many B.B.C. men, I wonder, scour the Continental ether each night in search of promising material for translation? Considering the paucity of original British microphone dramas, it should be well worth while to study the creative efforts of our friends in Europe.

The Brooklands Broadcast

ARRANGEMENTS have been completed for a relay from Brooklands of the Mountain Championship Race on October 19th. The race takes place over a circuit 1.2 miles in length, which has to be covered ten times, all cars starting from scratch, and the field is made up of some of the fastest track cars in the world.

It is too early to say who will be competing in the race this year, but it is naturally hoped that Whitney Straight will be there to defend his title and that Sir Malcolm Campbell will also take part. Earl Howe, Chris. Staniland, Raymond Mays, and Fred. Dixon may also figure in the entry list. The running commentary will be given by F. J. Findon.

Readers' Problems

In the Negative Lead

AUTOMATIC bias developed across a smoothing choke inserted in the negative output lead from the rectifier is virtually "free"—at any rate as free as anything is likely to be. That is why it has attracted a querist who is endeavouring to fit it to a somewhat ambitious experimental receiver fed from an HT supply unit with rather inadequate output. The loss of voltage that would arise by obtaining bias for the output valve in the normal manner can hardly be tolerated in this case; hence the adoption of the somewhat unconventional arrangement in question.

Now, although smoothing carried out in this manner is, in theory, quite effective, it suffers from one practical disadvantage which our correspondent has found out to his cost. He complains of a serious background of hum, and asks our advice as to how it may be overcome.

In these circumstances hum is generally attributable to the existence of a considerable amount of stray capacity, which virtually acts as a short-circuit across the smoothing choke. This arises through the fact that the capacity between the primary and the secondary windings of the power transformer is in normal circumstances (earthed mains and separately earthed receiver) applied across the choke.

The difficulty may be overcome by connecting the receiver earth in the manner indicated in Fig. 1 and not to the normal earth terminal of the set.

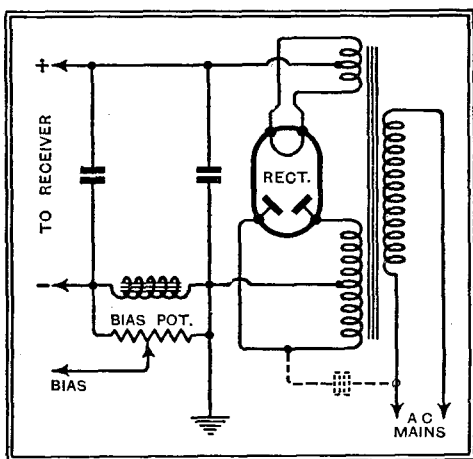

Fig. 1.—When the smoothing choke is in the negative lead, it is generally advisable to connect the earth lead as shown.

A certain difference of potential will exist between the receiver chassis and true earth, but that should not matter in an experimental set. The diagram also indicates (in dotted lines) the capacity that is responsible for the trouble.

Tuned Smoothing

AFTER applying the usual tests, a confessedly hypercritical reader has come to the conclusion that the slight background hum which is troubling him is due to the HT supply system of his set. As the present smoothing arrangements are

distinctly on the generous side, our correspondent has quite logically concluded that subtlety rather than brute force is called for; he has, therefore, decided that an extra smoothing circuit, tuned to the 100-cycle periodicity of the hum, should meet the case, and asks for information as to how this extra circuit may be added.

It is suggested that the "hum rejector" circuit should be wired as in Fig. 2. The choke may have an inductance of 25 henrys and the associated condenser a capacity of 0.1 mfd. It may be found that the tuning

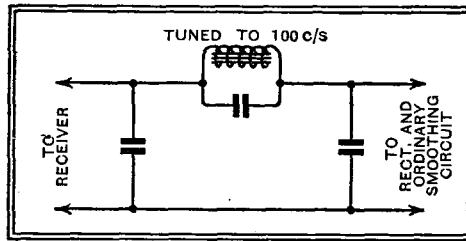

Fig. 2.—Connection of a tuned smoothing circuit.

of this circuit is fairly critical, and, as it is next door to impossible to obtain a choke that will have precisely the required value of inductance when carrying the current that normally flows through it, provision for interchanging the condenser may be made.

Upsetting Ganging

WHEN a screened aerial down-lead of the straightforward type (with low-capacity, low-loss cable) is fitted some increase in the effective capacity of the aerial as a whole is to be anticipated. Consequently, it is to be recommended that the aerial circuit of the set should be retrimmed. A querist recalls the fact that this advice was given in the "Readers' Problems" section some time ago; he goes on to ask whether the same applies when a "transmission-line" type of screened lead-in, with matching transformer at each end, is employed.

The safest answer to this question is "yes"; indeed, any alteration that may involve a change of aerial capacity implies a probable need for retrimming of the input circuit.

Heater-cathode Insulation

AUSER of a straight 2-HF set has recently discovered that the volume control becomes intermittently inoperative and at the same time distortion and a tendency towards instability becomes evident. The control is of the normal type, operating by variation of bias applied to the HF valves.

Here we have a fairly certain indication that the heater-cathode insulation of one of the HF valves is failing intermittently, and by so doing is imposing a short-circuit across the normal source of bias. It should be possible to check this, and also to ascertain which valve is faulty, by connecting a high-resistance voltmeter across the bias resistance with one valve only in use, and then waiting for the trouble to

THESE columns are reserved for the publication of matter of general interest arising out of problems submitted by our readers. Readers requiring an individual reply to their technical questions by post are referred to "The Wireless World" Information Bureau, of which brief particulars, with the fee charged, are to be found at the foot of this page.

manifest itself. It is impossible to make a good test of heater-cathode insulation except when the valve is working at its normal temperature.

Oscillator Output

IN describing the apparently inconsistent results of certain experiments which he has carried out with the help of a simple valve oscillator, a correspondent has apparently overlooked the fact that such apparatus can seldom be relied upon to give a consistent voltage output irrespective of frequency or wavelength. This applies to both modulated and unmodulated oscillators; the voltage of either will be dependent, to some extent at least, on the wavelength and/or the audio-frequency to which the modulation is adjusted.

To ensure constancy it is usual to employ a monitoring valve voltmeter across the output of the oscillator; for most purposes an uncalibrated device of the simplest type is quite adequate.

Restricted Waveband

A QUERIST who has just designed and constructed a "straight" 2-HF receiver which includes several interesting features is delighted with its general performance, but—never a rose without a thorn in the Information Department—he is disappointed to find that the wave-range coverage on the medium band is unduly restricted. The lowest wavelength that can be received is about 220 metres, in spite of the fact that special pains have been taken to avoid the introduction of unwanted stray capacities across the tuned circuits.

As the ganged tuning condenser and coils used by our correspondent are of good and suitable design, we can only think that this trouble is due to the fact that the trimming condensers are set at an unnecessarily high value. The set has already been carefully "ganged," but we suggest that the operation should be carried out again, making progressive small reductions in the capacity of all trimmers until the one set at the lowest value is nearly at minimum.

The Wireless World

INFORMATION BUREAU

THE service is intended primarily for readers meeting with difficulties in connection with receivers described in *The Wireless World*, or those of commercial design which from time to time are reviewed in the pages of *The Wireless World*. Every endeavour will be made to deal with queries on all wireless matters, provided that they are of such a nature that they can be dealt with satisfactorily in a letter.

Communications should be by letter to *The Wireless World* Information Bureau, Dorset House, Stamford Street, London, S.E.1, and must be accompanied by a remittance of 5s. to cover the cost of the service.

Personal interviews are not given by the technical staff, nor can technical enquiries be dealt with by telephone.